

NanoCove | Cove & Perimeter

Remote Driver



PRUDENTIAL LTG.

PRULITE.COM 213.746.0360



UP TO
110
LPW

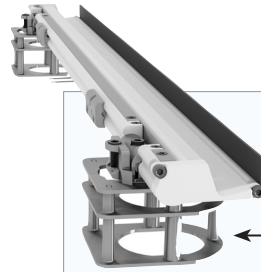

OPTIONAL BLACK FLANGE TO ELIMINATE LIGHT REFLECTIONS FROM FRONT OF UNFINISHED COVES ON THE BACK WALL

OPTIONAL LIFT FOR 0"-2" ADJUSTABLE HEIGHT

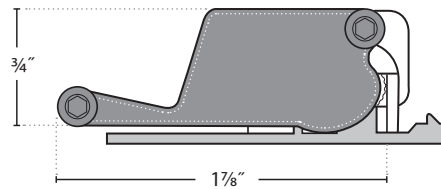

ACTUAL SIZE



Ultra-Compact Cove Lighting for Small Architectural Spaces

NanoCove is Prudential Lighting's ultra-compact cove lighting solution designed for smaller architectural coves. Delivering smooth, even illumination in coves as small as 3" x 1", NanoCove combines precision optics, adjustable aiming, and contractor-friendly installation in one compact, flexible system.

TUNABLE WHITE AVAILABLE:



LUMEN CHART

		LO	MO	SO	HO
HACW	Lm/Ft	300	400	600	1200
SACW	Lm/Ft	300	400	600	1200
TLMB	Lm/Ft	300	400	600	1200
	W/Ft	2.9	3.6	5.4	10.9

SERIES	LED COLOR	OUTPUT	NOMINAL LENGTH	FLANGE (OPTIONAL)	LIFT HEIGHT (OPTIONAL)	DISTRIBUTIONS	CIRCUITING	VOLTAGE	DRIVERS	OPTIONS & CONTROLS
NCVR										
Nano-Cove Remote	LED27 2700K (90CRI) LED3 3000K LED35 3500K LED4 4000K LED3-90 3 000K (90CRI) LED35-90 3500K (90CRI) LED4-90 4000K (90CRI) LED5-90 5000K (90CRI) PRUHUES: STATIC: BLU3S DYNAMIC: BLU3D* BLU35S BLU35D* BLU4S BLU4D* * Dynamic BIOS, SkyBlue spike can be dimmed, CCT warms slightly TU Tu-Hue 2700-6500K Tunable White TU2 Tu-Hue 2200-5000K Tunable White AMB AmberHue Warm Dim 2200K-5000K CHR ChromaHue RGBW (DMX at HO only)	LO Low MO Medium SO Standard HO High PROG Programmable Light Output (Specify desired lm/ft or w/ft)	1' 2' 3' 4' 5' 6' 7' 8' R____ (2" increments)	NON-FLG No Flange FLG Flange (Black)	NON-LIFT No Adjustable Height LIFT Adjustable Height	HACW Hard Ceiling Wash SACW Soft Ceiling Wash TLMB Tilted Lambertian	SC Single Circuit DC Dual Circuit	UNV (120-277) 347 (Emergency battery requires a Step Down transformer)	ND Non-Dimming DM01 0-10v, 1% Dimming (Standard) LDE1 Hi-lume 1% EcoSystem LED (Soft fade on, fade-to-black dimming) ECO 1% 0-10v, EldoLE (Logarithmic dimming std) ECDA 1% DALI, EldoLED (Logarithmic dimming std) nLight-Air Acuity nLight Drivers (ECDA driver ONLY) SOLO 0.1% 0-10v, EldoLED (Dim-to-dark, Logarithmic dimming std) SODA 0.1% DALI, EldoLED (Dim-to-dark, Logarithmic dimming std) STEP Signify Advance Step Dimming 2WIRE ELV/Forward/Reverse Phase Driver PRUHUES: E10V 2 Channel Color Control EDALI 2 Channel Color Control EDMX ChromaHue or Static White	EMHE CA T20 Emergency Battery (CA Title 20 compliant, 1000 delivered lumens, <4' Remote Only) ETS-DR Iota ETS-DR Emergency Transfer Switch PruTune Wall Device (EDALI only, one PruTune device for each zone)



VERTICAL ADJUSTABILITY

Lift Kit—

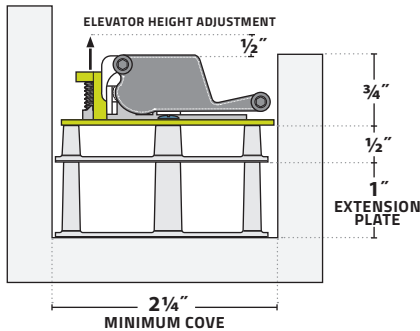

REFINED AESTHETICS

Adjustable Black Flange—

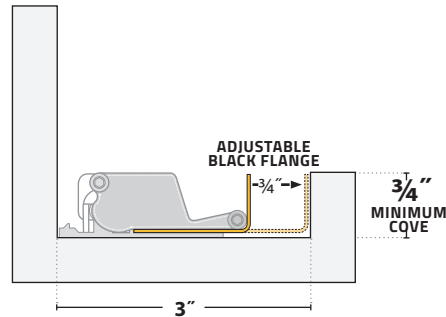

AIMING ROTATION

Preset Angle Spacers—

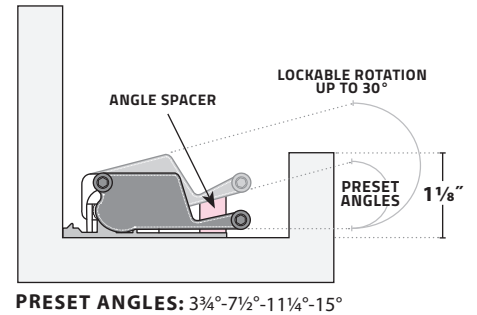

Low Beam Angle

Hard Ceiling Wash* is perfect for 6"+ cove heights



MAX CANDELA:
**1713 @
111°**



MAX CANDELA:
**1153 @
120°**

Multiple Optics

Three distinct distributions for any optical challenge

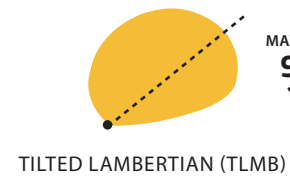

MAX CANDELA:
**922 @
130°**



PHOTOMETRICS:

HARD CEILING WASH

STANDARD OUTPUT:
NCVR-HACW-SO-4FT
 2322 Delivered Lumens
 21 Watts
 108 lm/w
 3500 CCT
MAX CANDELA:
 1713 @ 111°

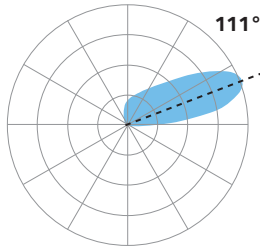

1713

Zonal Lumen Summary:
 0-90 = 100%

Vertical Angle	0°	45°	90°	135°	180°
90°	30	37	2	6	9
95°	319	332	21	11	13
105°	1542	871	82	19	25
125°	1286	769	213	60	50
135°	890	615	269	94	75
145°	681	537	316	139	109
155°	565	487	349	220	158
165°	476	442	371	294	255
175°	410	403	383	357	343
180°	381	381	381	381	381

SOFT CEILING WASH

STANDARD OUTPUT:
NCVR-SACW-SO-4FT
 2278 Delivered Lumens
 98 Watts
 113 lm/w
 3500 CCT
MAX CANDELA:
 1153 @ 120°

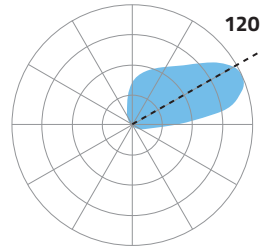

1153

Zonal Lumen Summary:
 0-90 = 100%

Vertical Angle	0°	45°	90°	135°	180°
90°	33	59	9	5	7
95°	182	339	36	4	4
105°	930	658	109	5	2
125°	1097	719	271	8	4
135°	949	673	349	109	132
145°	803	644	418	172	196
155°	713	628	476	239	265
165°	651	611	510	410	369
175°	587	572	541	505	432
180°	545	545	545	545	545

TILTED LAMBERTIAN

STANDARD OUTPUT:
NCVR-TLMB-SO-4FT
 2301 Delivered Lumens
 23 Watts
 99 lm/w
 3500 CCT
MAX CANDELA:
 922 @ 130°

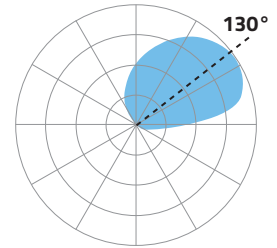

922

Zonal Lumen Summary:
 0-90 = 100%

Vertical Angle	0°	45°	90°	135°	180°
90°	6	14	3	5	5
95°	157	221	27	3	3
105°	658	581	116	3	2
125°	916	729	314	76	7
135°	911	750	398	199	103
145°	877	747	472	298	234
155°	819	723	528	389	345
165°	739	685	568	474	442
175°	645	628	591	555	542
180°	595	595	595	595	595

LUMEN MAINTENANCE

- L70** — 200,000+ Hours
- L90** — 100,000+ Hours (LO, MO & SO)
- L90** — 60,000+ Hours (HO)

LED SYSTEM LED modules and drivers are field replaceable.
PROG (OPTIONAL) Programmable light output. Specify desired lumens or watts per linear foot.

LABELS CSA and ETL damp labeled and I.B.E.W. manufactured.

ELECTRICAL Must specify LED dimming controls. LED fixtures have constant current driver(s) with less than 20% THD when loaded to a minimum of 60%. Drivers sink a maximum of 6mA per driver. DM01 LED drivers are 0-10V dimmable and are compatible with most 0-10V wall slide dimmers and direct 0-10V analog signal dimmers. Max driver size 1.65" w x 1.25" h.

CONSTRUCTION

- Housing** Extruded aluminum housing >25% PC recycled, 100% recyclable.
- Lens** Extruded acrylic with PruOptics™ prisms, 100% recyclable.
- Weight** .8 lbs/ft

MOUNTING Surface mounted to walls or ceilings in concealed coves.

WARRANTY Single-source, 5 year limited warranty covers standard components and construction.

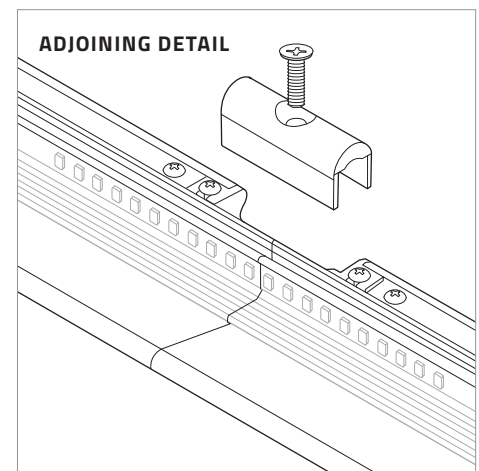



LIGHT INTENSITY GRAPHS: CEILING PLANE (PLAN VIEW)

Hard Ceiling Wash Soft Ceiling Wash Tilted Lambertian Tape & Channel (COMPETITOR)

TOP OF COVE TO CEILING: 6"

610	610	610	685	685	685	612	612	612	710	710	710
6"	6"	6"	6"	6"	6"	6"	6"	6"	6"	6"	6"
67	67	67	50	50	50	42	42	42	44	44	44
18"	18"	18"	18"	18"	18"	18"	18"	18"	18"	18"	18"
17	17	17	16	16	16	13	13	13	10	10	10
30"	30"	30"	30"	30"	30"	30"	30"	30"	30"	30"	30"
9	9	9	9	9	9	7	7	7	6	6	6
45"	45"	45"	45"	45"	45"	45"	45"	45"	45"	45"	45"
7	7	7	7	7	7	5	5	5	5	5	5
54"	54"	54"	54"	54"	54"	54"	54"	54"	54"	54"	54"
5	5	5	5	5	5	4	4	4	3	3	3
66"	66"	66"	66"	66"	66"	66"	66"	66"	66"	66"	66"
ILLUMINATION RANGE			ILLUMINATION RANGE			ILLUMINATION RANGE			ILLUMINATION RANGE		

TOP OF COVE TO CEILING: 9"

380	380	380	400	400	400	458	458	458	470	470	470
6"	6"	6"	6"	6"	6"	6"	6"	6"	6"	6"	6"
145	145	145	95	95	95	80	80	80	35	35	35
18"	18"	18"	18"	18"	18"	18"	18"	18"	18"	18"	18"
44	44	44	33	33	33	28	28	28	12	12	12
30"	30"	30"	30"	30"	30"	30"	30"	30"	30"	30"	30"
17	17	17	16	16	16	13	13	13	7	7	7
45"	45"	45"	45"	45"	45"	45"	45"	45"	45"	45"	45"
10	10	10	10	10	10	8	8	8	5	5	5
54"	54"	54"	54"	54"	54"	54"	54"	54"	54"	54"	54"
7	7	7	7	7	7	6	6	6	4	4	4
66"	66"	66"	66"	66"	66"	66"	66"	66"	66"	66"	66"
ILLUMINATION RANGE			ILLUMINATION RANGE			ILLUMINATION RANGE			ILLUMINATION RANGE		

TOP OF COVE TO CEILING: 12"

303	303	303	270	270	270	323	323	323	415	415	415
6"	6"	6"	6"	6"	6"	6"	6"	6"	6"	6"	6"
177	177	177	120	120	120	104	104	104	56	56	56
18"	18"	18"	18"	18"	18"	18"	18"	18"	18"	18"	18"
74	74	74	48	48	48	41	41	41	18	18	18
30"	30"	30"	30"	30"	30"	30"	30"	30"	30"	30"	30"
33	33	33	25	25	25	21	21	21	10	10	10
45"	45"	45"	45"	45"	45"	45"	45"	45"	45"	45"	45"
17	17	17	15	15	15	13	13	13	7	7	7
54"	54"	54"	54"	54"	54"	54"	54"	54"	54"	54"	54"
11	11	11	10	10	10	8	8	8	5	5	5
66"	66"	66"	66"	66"	66"	66"	66"	66"	66"	66"	66"
ILLUMINATION RANGE			ILLUMINATION RANGE			ILLUMINATION RANGE			ILLUMINATION RANGE		

TOP OF COVE TO CEILING: 18"

183	183	183	172	172	172	203	203	203	322	322	322
6"	6"	6"	6"	6"	6"	6"	6"	6"	6"	6"	6"
168	168	168	122	122	122	123	123	123	101	101	101
18"	18"	18"	18"	18"	18"	18"	18"	18"	18"	18"	18"
103	103	103	70	70	70	60	60	60	34	34	34
30"	30"	30"	30"	30"	30"	30"	30"	30"	30"	30"	30"
60	60	60	40	40	40	34	34	34	17	17	17
45"	45"	45"	45"	45"	45"	45"	45"	45"	45"	45"	45"
35	35	35	25	25	25	21	21	21	10	10	10
54"	54"	54"	54"	54"	54"	54"	54"	54"	54"	54"	54"
22	22	22	17	17	17	14	14	14	8	8	8
66"	66"	66"	66"	66"	66"	66"	66"	66"	66"	66"	66"
ILLUMINATION RANGE			ILLUMINATION RANGE			ILLUMINATION RANGE			ILLUMINATION RANGE		

CROSS SECTION:

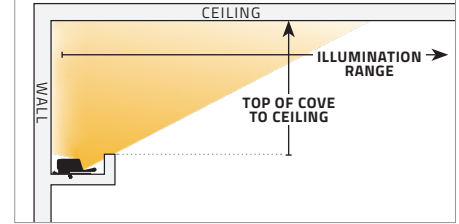



WIRING DIAGRAMS
SPEC



PRUDENTIAL LTG.

PRULITE.COM 213.746.0360



Prudential Lighting's **TuHue** Tunable White provides warm to cool white light simulating sunlight. Controlling the light source color temperature offers differing design aesthetics with potential benefits via circadian rhythm support. Blue light for alertness while warm light conveys tranquility.

- 2700K-6500K or 2200K-5000K.
- Adjust the color temperate and brightness separately.
- Simulates warm to cool to warm transition of sunlight.

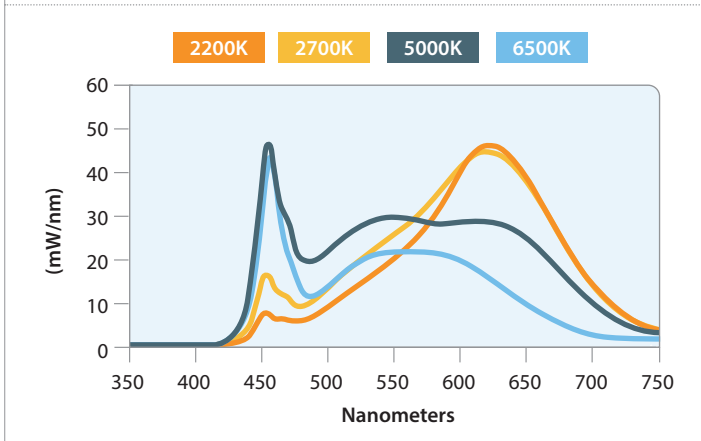
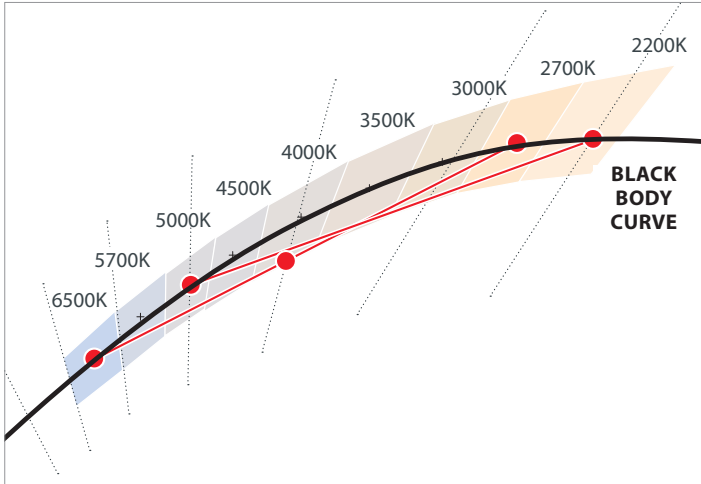

BluHue BIOS SkyBlue™ circadian LED lighting brings the benefits of blue skies inside. Newly discovered blue-sky receptors in our eyes drive improved daytime alertness, mood, brain function, and strengthens circadian rhythms leading to overall better health and well-being.



- Circadian rhythms play an integral role in physical and mental health.
- BluHue BIOS SkyBlue pinpoints peak 490nm sensitivity to provide the most benefit from an electric light source.
- At night, simply dim the lights to remove SkyBlue™ wavelengths (specify "Blu_D" to dim Cyan SkyBlue spike separately [night mode]).

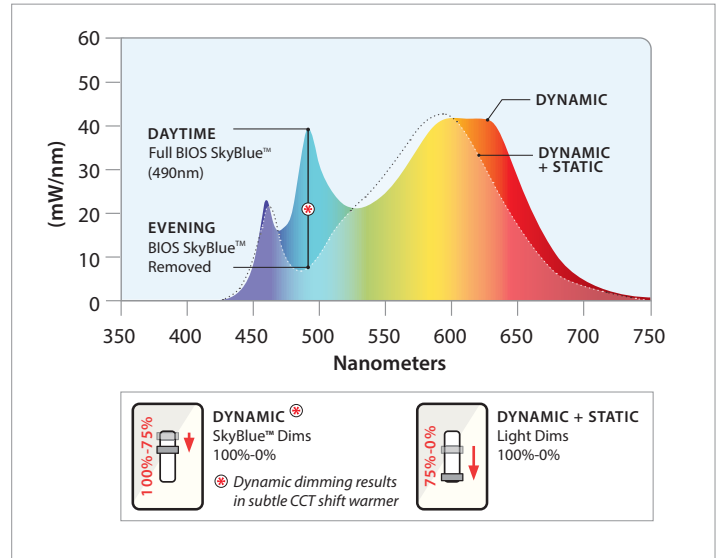

AmberHue is Prudential Lighting's Warm Dim offering. It transitions bright white light to warm amber light as brightness is dimmed, reflecting sunlight's transitioning from intense blue midday light to a dimmed golden hue near sunset, also reminiscent of soft glowing candlelight.

- Warm Dim 2200K-5000K.
- Color temperature warms as the luminaire is dimmed.
- Calm, relaxing mood communicated – hospitality, residential feel.

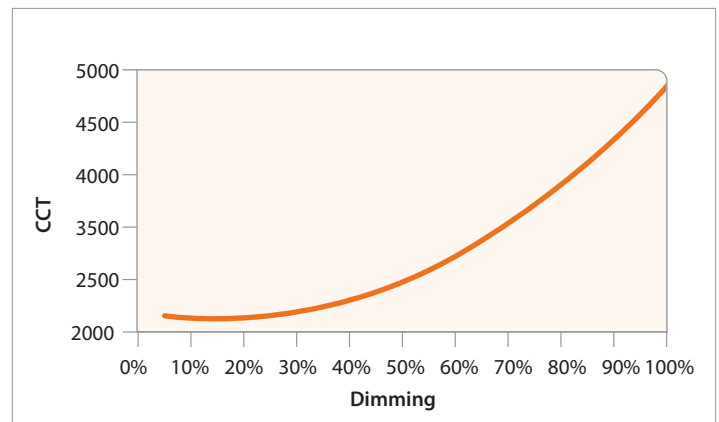



ChromaHue offers a vibrant full gamut of colors for seemingly endless architectural interior applications. Rich color-changing light offers tremendous design flexibility while white light can be achieved with the White chip, or mixing of Red, Green and Blue light. No longer just for the entertainment industry, ChromaHue can be intermixed on MicroCove luminaires for mood-creating indirect illumination combined with static white direct light.

- RGBW LED array (Red, Green, Blue, White) with full spectrum color and white light on the black body curve.
- Four-channel control, DMX drivers.
- Any color point within the triangle can be reached by setting the proper output levels for each individual red, green, blue and white channels.
- Standard DMX is one zone with one XLR drop at start, one XLR return at the end.

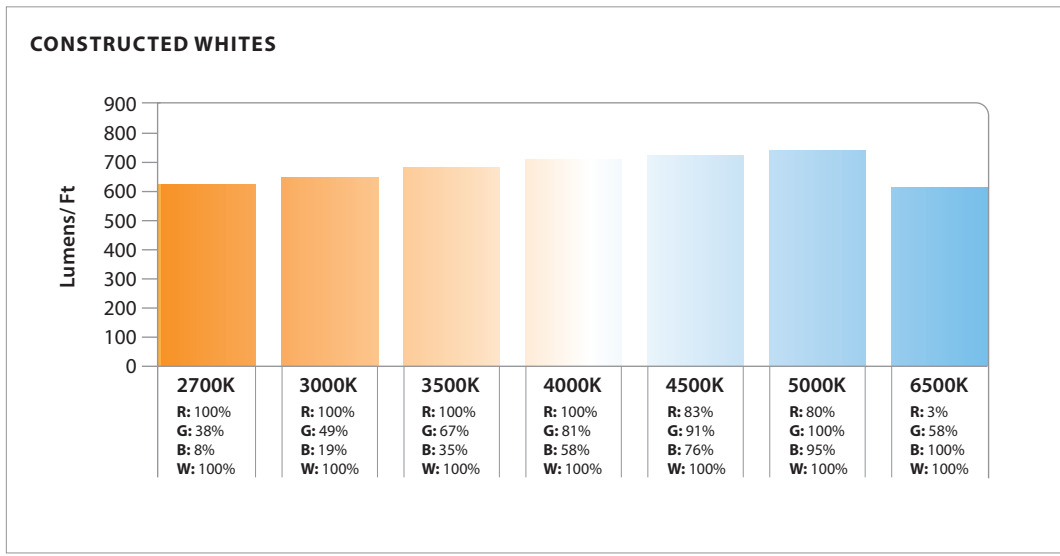
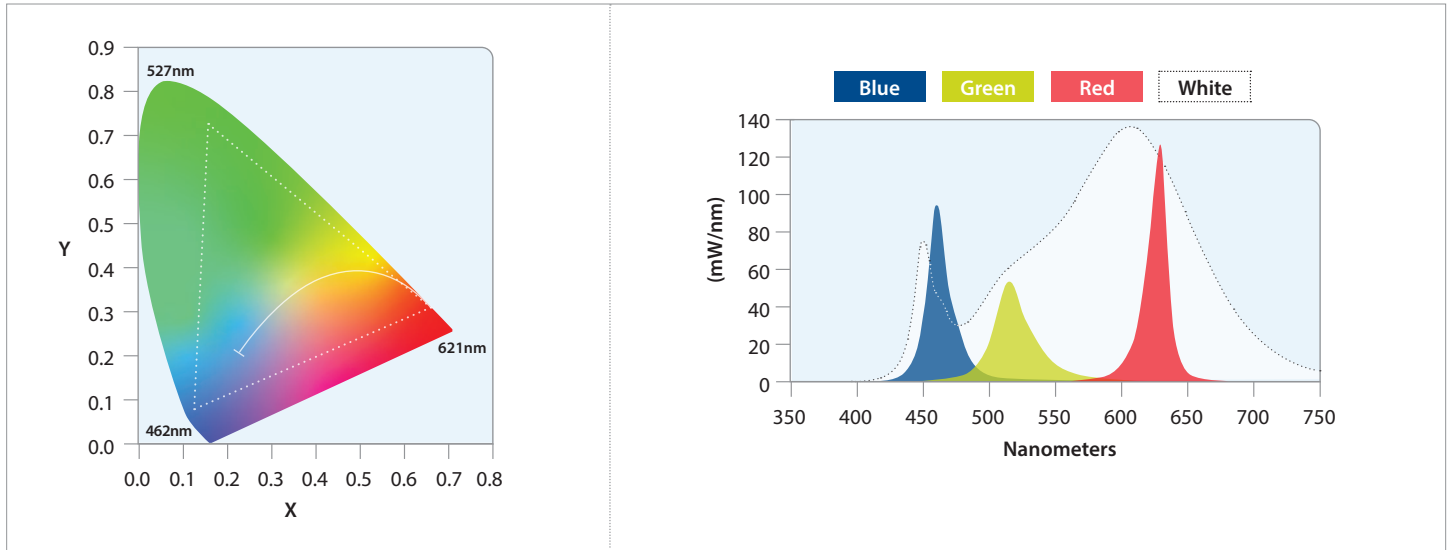



PRUTUNE WALL DEVICE

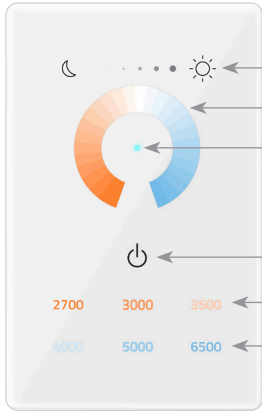

BRIGHTNESS: 0.1%-100%

COLOR WHEEL

POWER INDICATOR
RED : OFF
BLUE : ON

ON / OFF

PRESET COLOR TEMPERATURES

PRUTune DALI device includes:

- Easy-to-understand user control with intuitive design
- Out-of-the-box set-up, no commissioning needed
- Color wheel for color change from 2700K to 6500K
- Dimming to 0.1% (255 Steps)
- Six preset colors (2700K, 3000K, 3500K, 4000K, 5000K, 6500K)
- Must use DALI driver, consult factory to control non-Prudential Ltg Tunable White fixtures
- Control one (1) zone - up to 30 drivers
(Consult factory for fixture quantity dependant upon fixture type, size & output)

PRUTune + EMHE: — Prutune does not have memory

- Once normal power is restored, the controller sends a signal of 100% intensity and 6500K CCT

EXPLODED VIEW

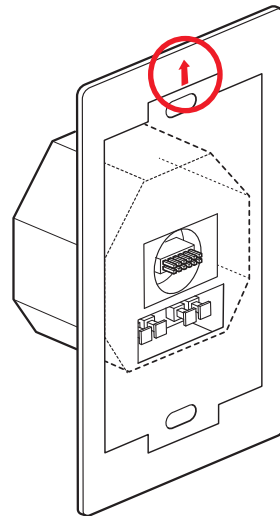
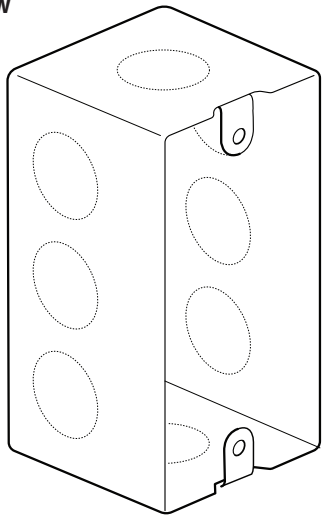

Ensure arrows are aligned when assembling 'Pru wall device'

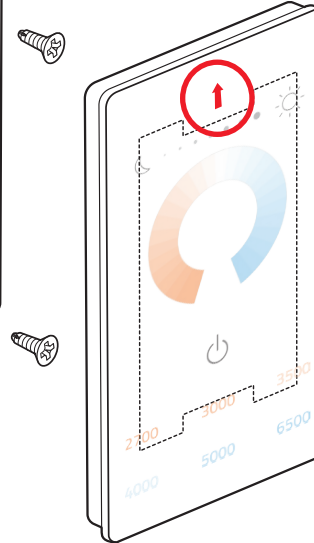



LM79 & TM30 DATA:

	MEASURED CCT	MEASURED LUMENS	CRI	R9	DuV	SPD	TM30 — COLOR VECTOR	TM30 — COLOR DISTORTION
LED27	2680	80%	93	58	0.001		89 Rf	97 Rg
LED3	3042	95%	82	6	0.001		81 Rf	92 Rg
LED3-90	3016	85%	93	61	0.000		88 Rf	96 Rg
LED35	3482	100%	82	3	0.002		81 Rf	92 Rg
LED35-90	3417	85%	93	67	0.000		88 Rf	96 Rg
LED4	3952	102%	82	4	0.003		81 Rf	92 Rg
LED4-90	3882	85%	92	67	0.003		87 Rf	96 Rg
LED5-90	4889	85%	94	84	0.002		86 Rf	95 Rg



LM79 & TM30 DATA:

		MEASURED CCT	MEASURED LUMENS	CRI	R9	LED27	SPD	TM30 — COLOR VECTOR
BH3S&D	bios 3000K	2779	2758	87	81	0.003		
	BH3D SKY BLUE DIMMED	2715	2425	82	3	0.002		
BH35S&D	bios 3500K	3245	2919	85	87	0.003		
	BH35D SKY BLUE DIMMED	3061	2502	83	7	0.001		
BH4&D	bios 4000K	3624	2993	85	86	0.004		
	BH4D SKY BLUE DIMMED	3388	2585	83	5	0.002		
TH	LED27	2684	2456	92	57	0.0001		
	LED65	6061	3292	82	-1	0.006		
TH2	LED22	2209	2112	92	52	0.0005		
	LED50	4796	2789	93	77	0.004		
CH	2700K	2632	2469	82	50	0.003		
	3500K	3388	2585	83	5	0.002		
	4000K	3977	2682	83	29	0.003		
	5000K	5233	2823	84	21	0.003		