

Wet BionicPro | Recessed Linear





X3/X11 — Hard Ceiling

INSTALLATION INSTRUCTIONS



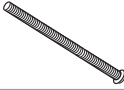

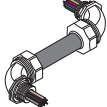

PRUDENTIAL LTG.

PRULITE.COM 213.746.0360

PART	PART NO.	DESCRIPTION
	100-00283-14	¼-20 x 5.0 Round Head Combination Drive Machine Screw
	100-00255-14	¼-20 Hex Nut
	100-00426-14	¼-20 x.875L Philips Screw ZPS
	100-00486-10	Seam Reflector
	100-00621-09	LFMC—Liquid Tight Assembly 6'0.5" NPT Connector, ¾" Flex Conduit

LENS INSTALLATION:

	100-00943-10	Wet BionicPro2 — Lens Sponge Tool
	100-00944-10	Wet BionicPro3 — Lens Sponge Tool
	100-00945-10	Wet BionicPro4 — Lens Sponge Tool
	100-00946-10	Wet BionicPro5 — Lens Sponge Tool
	100-00014-25	Lens Lube

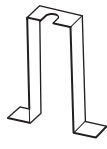
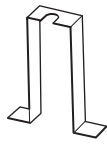
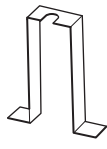
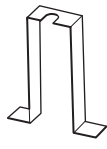

ROW MOUNTING GASKET:

	100-00451-17	Wet BionicPro2 — Joiner Gasket BLACK
	100-00452-17	Wet BionicPro2 — Joiner Gasket WHITE
	100-00453-17	Wet BionicPro3 — Joiner Gasket BLACK
	100-00454-17	Wet BionicPro3 — Joiner Gasket WHITE
	100-00455-17	Wet BionicPro4 — Joiner Gasket BLACK
	100-00456-17	Wet BionicPro4 — Joiner Gasket WHITE
	100-00457-17	Wet BionicPro5 — Joiner Gasket BLACK
	100-00458-17	Wet BionicPro5 — Joiner Gasket WHITE

PART	PART NO.	DESCRIPTION	QTY
MOUNTING JIG:			
	173723	Wet BionicPro2 — Mounting JIG	
	173724	Wet BionicPro3 — Mounting JIG	
	173725	Wet BionicPro4 — Mounting JIG	
	173726	Wet BionicPro5 — Mounting JIG	

ASSEMBLY KIT BREAKOUT KIT: 100-00206-08

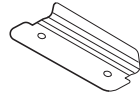
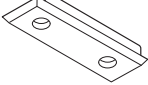
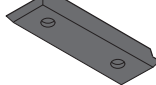
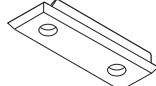
	Die Casted MainPart	1
	One-sided Adhesive Gasket	2
	Die Casted Shaft Collar	1
	18-8 Stainless Steel ¼ x 20 Hex Nut	1
	18-8 Stainless Steel Socket Head Screw	2

LENS CLAMP KIT:	BPRO2	BPRO3	BPRO4	BPRO5	
	Lens Clamp Bracket	170523	170524	170525	170526
	X3 Endplate Clamp Cap	100-00253-03	100-00254-03	100-00255-03	100-00256-03
	Molded Clamp Gasket—Black	100-00153-17	100-00154-17	100-00155-17	100-00156-17
	Molded Clamp Gasket—White	100-00075-17	100-00459-17	100-00076-17	100-00077-17
	Socket Head Cap Screw 6-32 x ¾"	100-00423-14			
	Black Nylon Flat Washer .140ID x 312OD	100-00422-14			



Prudential Ltg. reserves the right to change design specifications or materials without notice. Please visit prulite.com for most current data.
© 2026 All rights reserved—All products manufactured at: Prudential Lighting, 1774 E. 21st Street, Los Angeles, CA 90058.

Wet BionicPro | Recessed Linear

X3/X11 — Hard Ceiling

INSTALLATION INSTRUCTIONS





PRUDENTIAL LTG.

PRULITE.COM 213.746.0360

PARTS LIST	LENGTH	PART NO.							
LENSES:		SAL	BTW	WWF	WWG	PFL	NGZ	MGZ	WGZ
	8'	183559	183551	183567	183575	183583	183591	183599	183607
	7'	183560	183552	183568	183576	183584	183592	183600	183608
	6'	183561	183553	183569	183577	183585	183593	183601	183609
	5'	183562	183554	183470	183578	183586	183594	183602	183610
	4'	183563	183555	183471	183579	183587	183595	183603	183611
WET BIONICPRO2	3'	183564	183556	183472	183580	183588	183596	183604	183612
	2'	183565	183557	183473	183581	183589	183597	183605	183613
	ROLL	100-01152-10							

PARTS LIST	LENGTH	PART NO.							
LENSES:		SAL	BTW	WWF	WWG	PFL	NGZ	MGZ	WGZ
	8'	173834	173826	173842	173850	173858	173866	173874	173882
	7'	173835	173827	173843	173851	173859	173867	173875	173883
	6'	173836	173828	173844	173852	173860	173868	173876	173884
	5'	173837	173829	173845	173853	173861	173869	173877	173885
	4'	173838	173830	173846	173854	173862	173870	173878	173886
WET BIONICPRO3	3'	173839	173831	173847	173855	173863	173871	173879	173887
	2'	173840	173832	173848	173856	173864	173872	173880	173888
	ROLL	100-00501-10							

PARTS LIST	LENGTH	PART NO.							
LENSES:		SAL	BTW	WWF	WWG	PFL	NGZ	MGZ	WGZ
	8'	183623	183615	183631	183639	183647	183655	183663	183671
	7'	183624	183616	183632	183640	183648	183656	183664	183672
	6'	183625	183617	183633	183641	183649	183657	183665	183673
	5'	183626	183618	183634	183642	183650	183658	183666	183674
	4'	183627	183619	183635	183643	183651	183659	183667	183675
WET BIONICPRO4	3'	183628	183620	183636	183644	183652	183660	183668	183676
	2'	183629	183621	183637	183645	183653	183661	183669	183677
	ROLL	100-01153-10							

PARTS LIST	LENGTH	PART NO.							
LENSES:		SAL	BTW	WWF	WWG	PFL	NGZ	MGZ	WGZ
	8'	183687	183679	183695	183703	183711	183719	183727	183735
	7'	183688	183680	183696	183704	183712	183720	183728	183736
	6'	183689	183681	183697	183705	183713	183721	183729	183737
	5'	183690	183682	183698	183706	183714	183722	183730	183738
	4'	183691	183683	183699	183707	183715	183723	183731	183739
WET BIONICPRO5	3'	183692	183684	183700	183708	183716	183724	183732	183740
	2'	183693	183685	183701	183709	183717	183725	183733	183741
	ROLL	100-01153-10							

WARNING: Ground fixture in accordance with local and national electrical codes. Failure to do so may result in serious personal injury. Fixture Installations should ONLY be done by a qualified licensed electrical professional.

Wet BionicPro | Recessed Linear

X3/X11 — Hard Ceiling

INSTALLATION INSTRUCTIONS



HARD CEILING X1/X7/X11 — MOUNTING DIMENSIONS

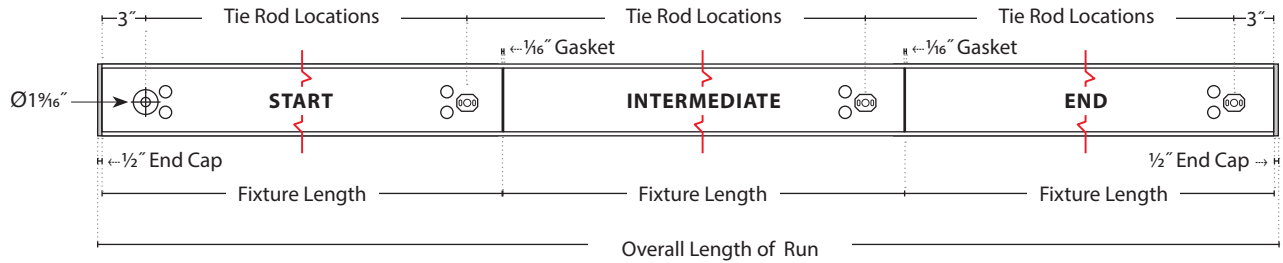

	FIXTURE LENGTHS	TIE ROD LOCATIONS	
		Start / Individual	Intermediate / End
2'	24"	18"	—
3'	36"	30"	36 ¹ / ₁₆ "
4'	48"	42"	48 ¹ / ₁₆ "
5'	60"	54"	60 ¹ / ₁₆ "
6'	72"	66"	72 ¹ / ₁₆ "
7'	84"	78"	84 ¹ / ₁₆ "
8'	96"	90"	96 ¹ / ₁₆ "

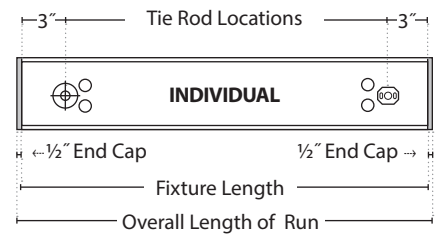

POWER FEED LOCATIONS:

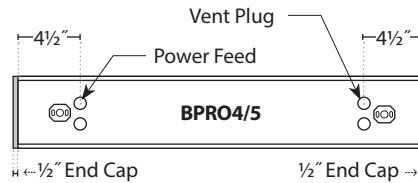
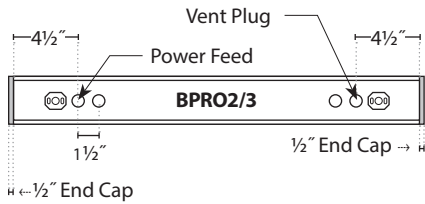

WARNING: Ground fixture in accordance with local and national electrical codes. Failure to do so may result in serious personal injury. Fixture installations should ONLY be done by a qualified licensed electrical professional.

Wet BionicPro | Recessed Linear

X3/X11 — Hard Ceiling

INSTALLATION INSTRUCTIONS



PRUDENTIAL LTG.

PRULITE.COM 213.746.0360

1a) Run ¼-20 All-thread from structure to fixture mounting locations for support and joists for flange mounting. Install rough electrical.

See mounting locations (page 2).

1b) OPTIONAL
Screw Overhead Mounting Brackets (OMB) to joists (screws by others). Install rough-in electrical.

2) — Install drywall.
— Cut rough-in holes.

See mounting locations (page 2).

3) Remove cardboard inserts and reflectors. Leave LED assembly in place.

4) Run power into fixture using a wet rated conduit (provided by others). A LFMC—Liquid Tight Assembly 6' 0.5" NPT Connector, ¾" Flex Conduit will be provide.

NOTE: Conduit provided is not plenum rated.

WIRING:

0-10V (+) : Purple	0-10V (-) : Pink
DALI (+) : Purple	DALI (-) : Pink
EcoSystem DALI (+) : Purple	EcoSystem DALI (-) : Pink
HOT : BLACK	
NEUTRAL : WHITE	
GROUND : GREEN	
Constant Hot (EM) / Dimming : Red	
Extra Hot / Dimming : Blue	
Extra Hot / Dimming : Orange	

5) BPRO2 + 3 EMHE EMERGENCY AND LUTRON AT SO ONLY.

Insert insulation detector into knockout.

NOTE: BPRO2 & 3 are not IC-rated for insulation with emergency.
WARNING: Warranty voided if insulation detector is removed or not snapped into place.

WARNING: Ground fixture in accordance with local and national electrical codes. Failure to do so may result in serious personal injury. Fixture Installations should ONLY be done by a qualified licensed electrical professional.

Wet BionicPro | Recessed Linear X3/X11 — Hard Ceiling

INSTALLATION INSTRUCTIONS



PRUDENTIAL LTG.

PRULITE.COM 213.746.0360

X3
Hard Ceiling Flange Trim

X11
Finished Extruded Side

FLUSH

HARD CEILING OPENING:

APERTURE	BPRO3
W = FIXTURE WIDTH	3 1/2"
X = CEILING OPENING (FLUSH)	3 1/4"
FIXTURE ROUGH IN LENGTH =	Fixture Length + 1 5/16"

MOUNTING INSTALLATION

1) Cut 1/4-20 rod to appropriate height using JIG provided. Ensure JIG flanges are flushed to the ceiling opening.

CUT LOCATION

BOTTOM VIEW

2a) Prep MainPart. Apply adhesive backed gasket to the MainPart in between the ledges.

2b) Screw MainPart on the 1/4-20 rod two threads, using the JIG provided as a reference on when to stop. A 3/16" HEX key or T-handle can be used. A gap should be left (approximately 1/4").

NOTE: After all MainParts are screwed on 1/4-20 rod appropriately JIG can be disposed.

3a) Prep Shaft Collar. Apply adhesive backed gasket to the Shaft Collar in between the ledges.

WARNING: Ground fixture in accordance with local and national electrical codes. Failure to do so may result in serious personal injury. Fixture Installations should ONLY be done by a qualified licensed electrical professional.

Wet BionicPro | Recessed Linear X3/X11 — Hard Ceiling

INSTALLATION INSTRUCTIONS



PRUDENTIAL LTG.

PRULITE.COM 213.746.0360

- 3b)** Attach a 6-Point Standard Socket to a drill. (Suggested size: $\frac{7}{16}$ " with the shaft opening having a MAX ID of 0.63"). Place the 18-8 HEX nut into Socket and put Shaft Collar on top of drill bit.

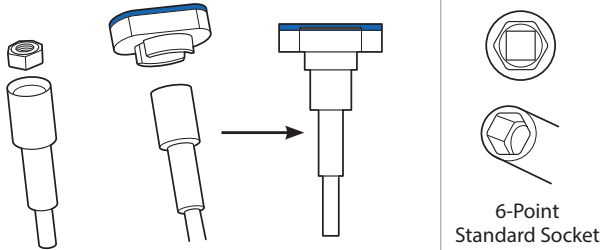

- 4a)** Place fixture in place according to the two mounting cut outs.

BOTTOM VIEW

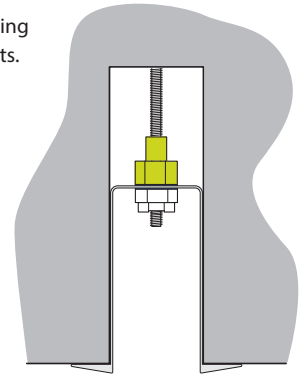
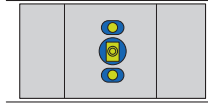

- 4b)** Screw Nut and Shaft Collar onto MainPart until the nut bottoms out against the MainPart and the fixture trim is flushed with the ceiling opening.

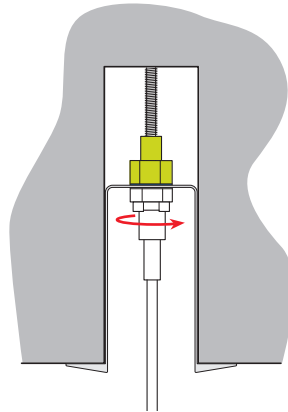

- 4c)** If fixture trim is not flush with the ceiling opening readjust the height of the Mainpart by inserting a $\frac{1}{8}$ " L-key or drill bit extension to the HEX opening at the bottom.

BOTTOM VIEW

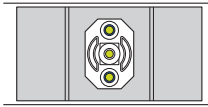

NOTE: Ensure the long edge of the shaft collar is parallel to long edge of the fixture.

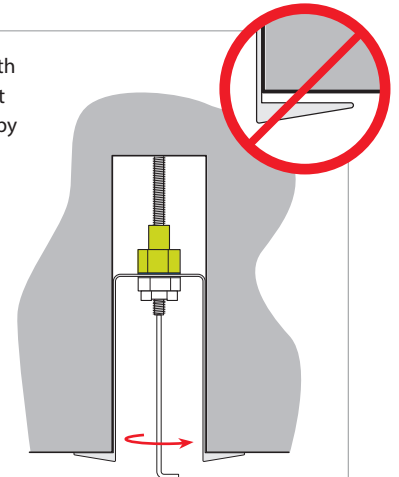

- 5)** Screw in both Socket Head Screws until tight with a $\frac{3}{16}$ " HEX key or T-handle.

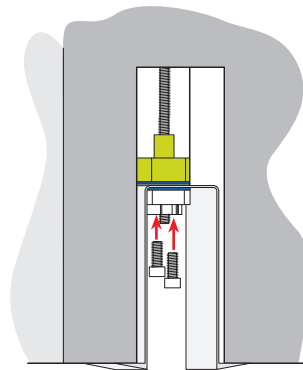
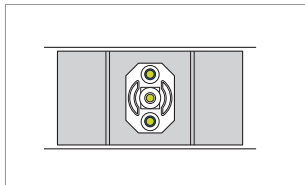

WARNING: Ground fixture in accordance with local and national electrical codes. Failure to do so may result in serious personal injury. Fixture Installations should ONLY be done by a qualified licensed electrical professional.

Wet BionicPro | Recessed Linear

X3/X11 — Hard Ceiling

INSTALLATION INSTRUCTIONS



PRUDENTIAL LTG.

PRULITE.COM 213.746.0360

STEPS 6-7 FOR ROWS ONLY, FOR INDIVIDUALS CONTINUE TO STEP 9

6) Install next fixture
NOTE: Taper Pins (→) are installed on **MALE** side of electrical power connections for easy alignment of continuous rows

M MALE **F** FEMALE



7a)

Remove adhesive backer from both sides of row gasket and fit gasket over pins and apply to end of fixture.

7b)

Align taper pins with holes in adjoining fixture.

7c)

Install (4) 1/4-20 x 5" bolts into bracket and pull fixtures tight, ensuring that gasket stays in place at lens area. The top row of screws screw into captive nuts that are fixed in the adjoining bracket. The bottom row require mating with separate lock nuts.

NOTE: APPLY PRESSURE TO GASKET TABS WHILE TIGHTENING TO KEEP IN PLACE.

8b) Make electrical and dimming harness connections and slide fixtures together — making sure Taper pins are aligned

M MALE **F** FEMALE

TAPER PINS DETAIL

REGRESS ALIGNER DETAIL

9a)

1. REMOVE LED ASSEMBLY
2. ROTATE LED ASSEMBLY
3. INSERT LED ASSEMBLY AGAINST STIFFENER

Wet BionicPro | Recessed Linear

X3/X11 — Hard Ceiling

INSTALLATION INSTRUCTIONS



INSTALLATION
VIDEO



PRUDENTIAL LTG.

PRULITE.COM 213.746.0360

LENS INSTALLATION

REQUIRES TWO PEOPLE TO INSTALL

⚠️ PRIOR TO INSTALLING LENS, ENERGIZE LEDS AND CONFIRM ALL ARE PROPERLY LIT BEFORE INSTALLING LENS

RECOMMENDED: Start lens installation from *LEFT* to *RIGHT*.



1) Insert clamp brackets at the **START** and **END** of the fixture.

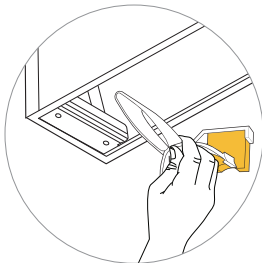

Use handle of 'Lens Tool' to tap bracket into place

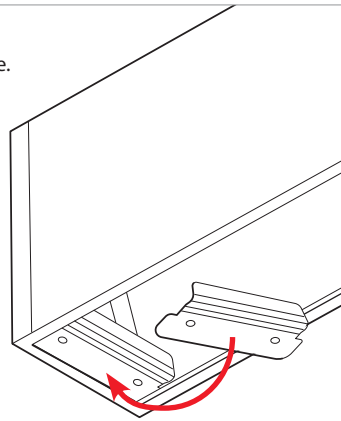

2) Insert lens into start of fixture by hand with an extra 3" overhang. Squeeze one edge of gasketed lens, then the other.

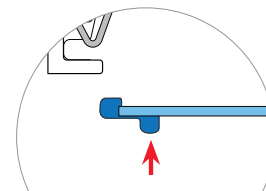

NOTE: Lens BUMP faces DOWN

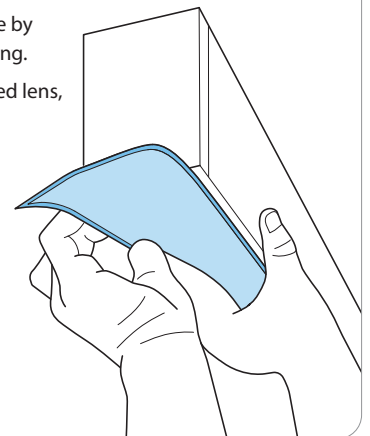

3) With lens partially inserted into fixture, snap lens into lens tool with the sponge side of tool facing the opposite end of fixture. Guide edges of lens gasket through sponge grooves. Apply lens lube liberally to sponge grooves on both sides.

Lens Lube

APPLY LENS LUBE TO SPONGE IN GROOVED AREAS

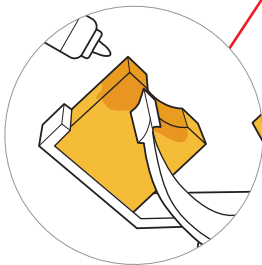

LENS BEAD FACING DOWN, WITH LENS BOWED OUT

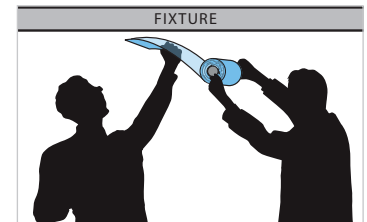
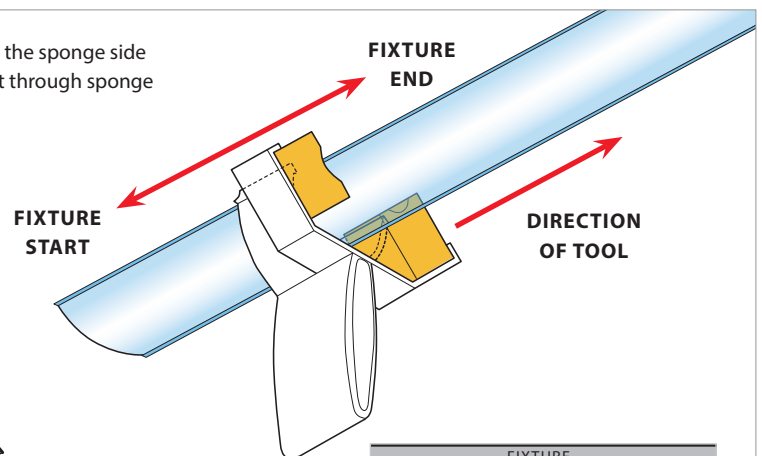
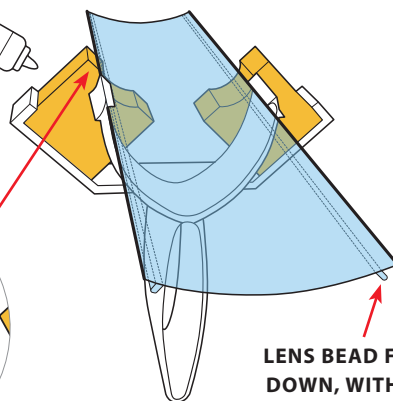

WARNING: Ground fixture in accordance with local and national electrical codes. Failure to do so may result in serious personal injury. Fixture Installations should **ONLY** be done by a qualified licensed electrical professional.



Prudential Ltg. reserves the right to change design specifications or materials without notice. Please visit prulite.com for most current data. © 2026 All rights reserved—All products manufactured at: Prudential Lighting, 1774 E. 21st Street, Los Angeles, CA 90058.

Wet BionicPro | Recessed Linear X3/X11 — Hard Ceiling

INSTALLATION INSTRUCTIONS



INSTALLATION
VIDEO



PRUDENTIAL LTG.

PRULITE.COM 213.746.0360

LENS INSTALLATION

REQUIRES TWO PEOPLE TO INSTALL

4a)

With lens inserted into tool, squeeze and push tool tabs into slots in fixture opening.

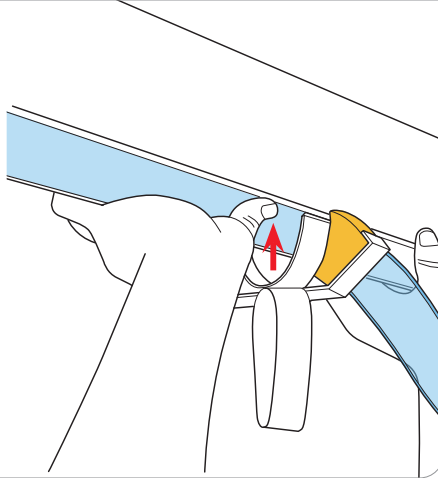

4b)

Apply pressure to the middle of the lens where it is bowed out. This will push the gasket into the lens slot. Ensure that the gasket is pressed firmly against the inside fixture lip.

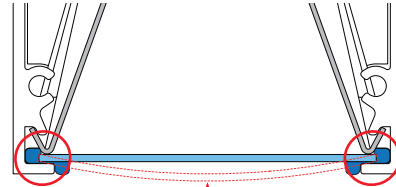

PUSH LENS FLAT WHERE IT IS BOWED OUT
GASKET BEAD MUST BE PRESSED UP
AGAINST INSIDE FIXTURE LIP

5)

Slide Lens Tool forward to insert lens

NOTE: Keep Lens Tool square,
DO NOT twist.

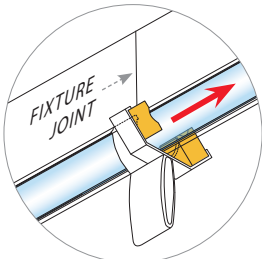

NOTE: Slow down
sliding at fixture joints.

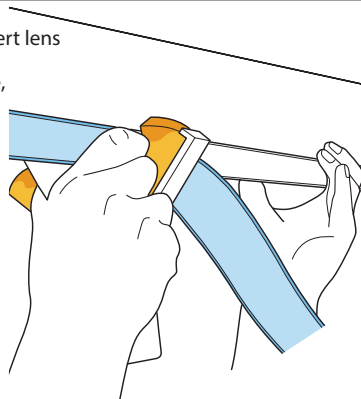

REAPPLY LUBRICANT
TO SPONGES AS NEEDED.

6)

Leaving an inch of lens at the END of the fixture,
trim the lens from the roll.

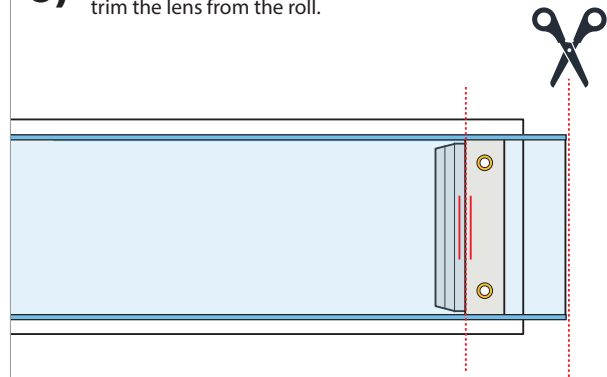

7) Using Square, mark side of fixture where to cut lens
within 1/8" safety zone Transfer **CUT LINE** to Lens,
using square draw **CUT LINE** across lens

NOTE: Mark as close to end cap as possible (max line)

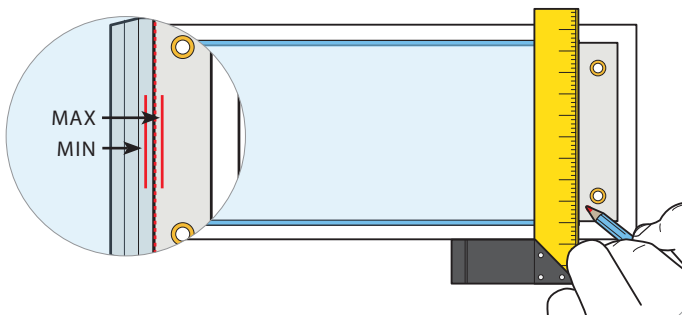

8)

CUT LENS: In order to not cut lens too short, it is easier to
make multiple cuts that are gradually closer to marked line.

DO NOT cut too short,
requires new lens

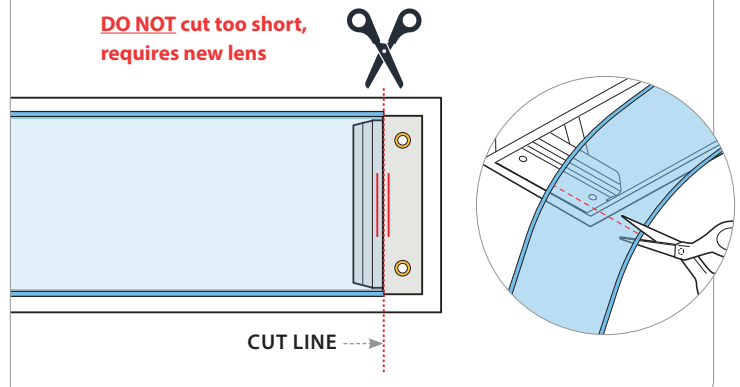

WARNING: Ground fixture in accordance with local and national electrical codes. Failure to do so may result in serious personal injury
Fixture Installations should ONLY be done by a qualified licensed electrical professional.



Prudential Ltg. reserves the right to change design specifications or materials without notice. Please visit prulite.com for most current data.
© 2026 All rights reserved—All products manufactured at: Prudential Lighting, 1774 E. 21st Street, Los Angeles, CA 90058.

Wet BionicPro | Recessed Linear X3/X11 — Hard Ceiling

INSTALLATION INSTRUCTIONS



INSTALLATION
VIDEO



PRUDENTIAL LTG.

PRULITE.COM 213.746.0360

LENS INSTALLATION

REQUIRES TWO PEOPLE TO INSTALL

- 9)** As you near the end of the fixture, remove lens tool and install remaining lens by hand. Tuck the end sections of gasket between the bracket and the inside of the lens opening.

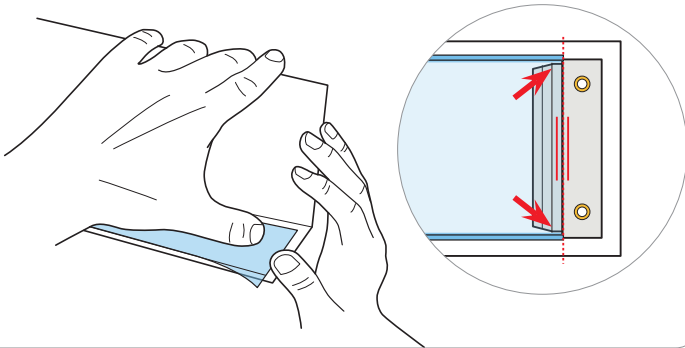

- 10)** Install Clamp cap with gasket using $\frac{7}{64}$ " HEX socket. Hand tighten screws.

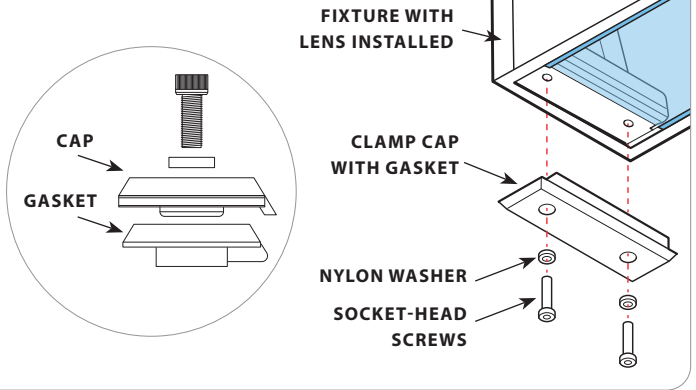

- 10)** Repeat lens trimming and clamp cap installation at beginning of fixture.

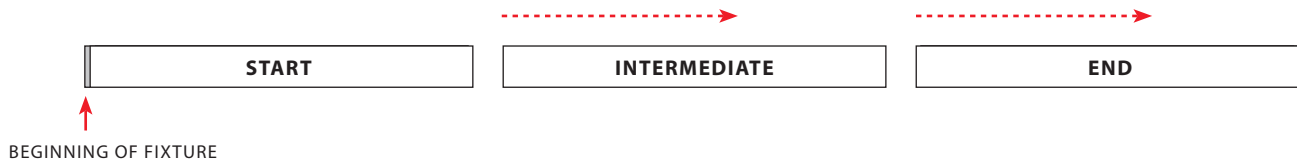

WARNING: Ground fixture in accordance with local and national electrical codes. Failure to do so may result in serious personal injury. Fixture Installations should ONLY be done by a qualified licensed electrical professional.

Wet BionicPro | Recessed Linear X3/X11 — Hard Ceiling

INSTALLATION INSTRUCTIONS



PRUDENTIAL LTG.

PRULITE.COM 213.746.0360

LENS REMOVAL

REQUIRES TWO PEOPLE TO INSTALL

1)

Use a $\frac{7}{64}$ " hex wrench to remove socket head screws to release Clamp Caps from both ends of fixture.

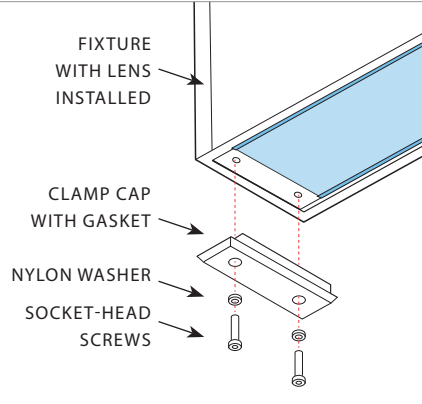

2)

Pry the lens loose at the end with a small slotted screwdriver just enough to make some space between the lens and the bracket

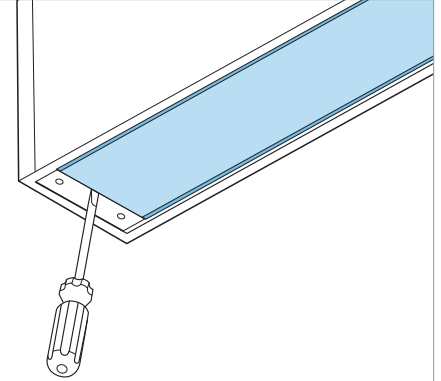

3)

Use your fingers to gently pry the lens out from the center while pulling the gasket loose from the lens slot.

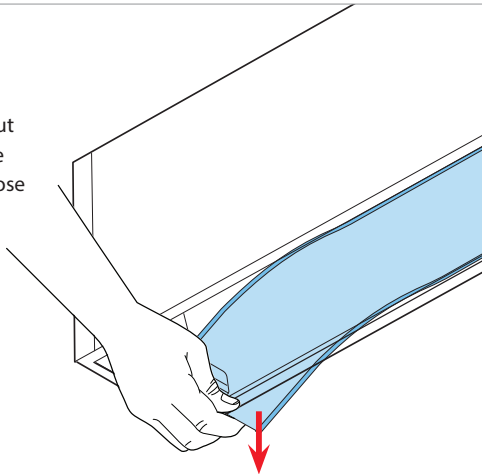

4)

Continue slowly prying the lens from inside of the fixture cavity, releasing the gasket from each side as you go.

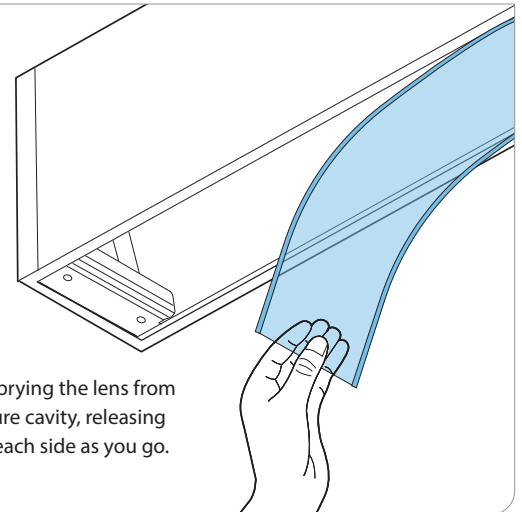

5)

Feed lens into lubricated tool and slowly reverse direction of install, pulling lens out as you go.

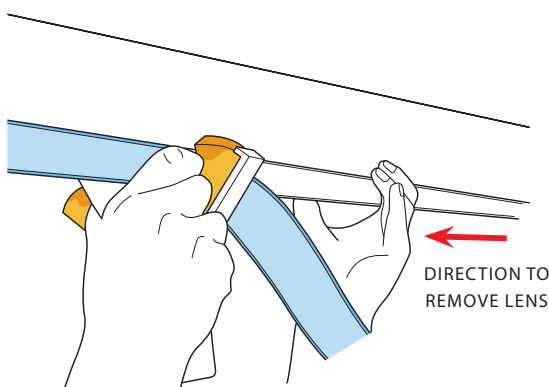

WARNING: Ground fixture in accordance with local and national electrical codes. Failure to do so may result in serious personal injury. Fixture Installations should ONLY be done by a qualified licensed electrical professional.