

BionicPro5 Square | Pendant, Surface & Wall

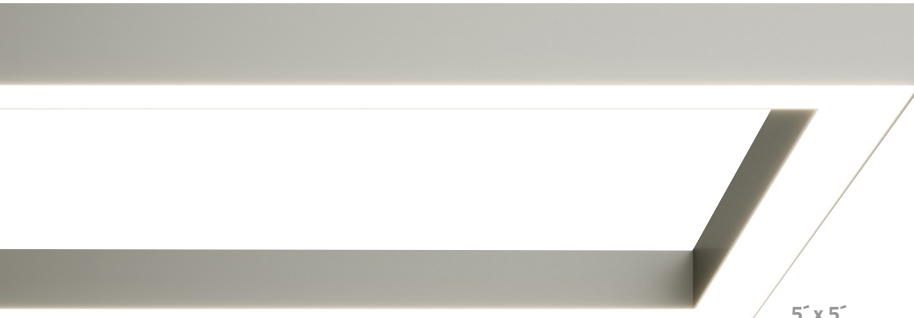

PRUDENTIAL LTG.

PRULITE.COM 213.746.0360



5" x 5"

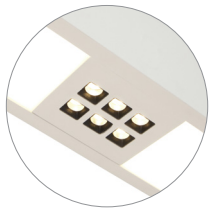

DOWNLIGHTS

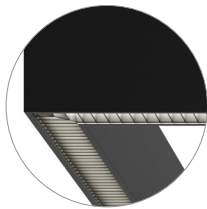

LOUVERS

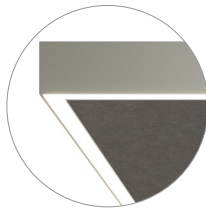

ACOUSTICS

Declare.



Made in the USA

Lumen output may vary +/- 5%
3500K used for lm/ft estimates above
4000K +2% If, 3000K -2%, 2700K -4%
-10% LLF for 90 CRI (4K, 3500K and 3K)

LUMEN CHART: SAL

	LO	MO	SO	HO
22:	Im 3800	5700	7900	9900
	w 31	45	63	84
33:	Im 5800	8500	11800	14900
	w 46	67	94	126
44:	Im 7700	11400	15800	19900
	w 61	90	125	168
55:	Im 9700	14300	19800	24900
	w 76	112	156	210

SERIES	SIZE	LENS POSITION	LED COLOR	OUT-PUT	DISTRIBUTION	ACOUSTIC COLORS (OPTIONAL)	COLOR/ FINISH	LOUVER COLOR	CIRCUITING	VOLT-AGE	MOUNT-ING	CEILING SYSTEMS	DRIVERS	OPTIONS & SENSORS	
BPRO5 SQ-LIN															
BionicPro5 Square	22 2' x 2'	FLSH Flush Lens	LED27 2700K (90CRI) LED3 3000K LED35 3500K LED4 4000K LED3-90 3000K (90CRI) LED35-90 3500K (90CRI) LED4-90 4000K (90CRI) LED5-90 5000K (90CRI)	LO Low MO Medium SO Standard HO High	Choose Down-AND-Up DOWN: NW No Direct SAL Satin Lens BTW Batwing WWF Flat Wall Wash WWG Focal Glow Wash PFL Perimeter Wash Room Fill MGZ Medium Wall Graze LGP Low Glare Prismatic (NA HO)	UP: NU No Indirect SYM Sym-metric (Frosted ADC, Standard) HCW Hard Ceiling Wash MCW Medium Ceiling Wash SCW Soft Ceiling Wash SACW Soft Asym-metric Ceiling Wash	STANDARD: DB05 White DB03 Marble DB33 Grey PREMIUM: (LONGER LEAD TIMES) DB02 Oat DB27 Teal DB24 Stone DB26 Sky Blue DB09 Yellow DB16 Orange DB10 Red DB28 Hickory DB12 Pink DB01 Sand DB06 Pear DB36 Black DB20 Lime DB23 Honey DB18 Maroon DB14 Violet DB29 Brown	TMW Textured Matte White YGW Gloss White (Standard) Y Pre-mium Color CC Custom Color LUXE METAL-LICS: YBZ Bronze YCP Copper Penny YGN Gold Nugget	SKIP COLUMN IF LOUVER IS NOT NEEDED TMW Textured Matte White YGW Gloss White (Standard) Y Pre-mium Color CC Custom Color LUXE METAL-LICS: YBZ Bronze YCP Copper Penny YGN Gold Nugget	SC Single Circuit DC Dual Circuit	UNV (120-277) 347 (Emergency battery re-quires remote driver box)	SUR Surface Mount (Only available with NU Up option) SPM48", 96" or 144" Square Cast Aluminum Canopy CA48", 96" or 144" Aircraft Cable (Adjustable)	X1-ON T-Bar X1-OFF T-Bar X3 Hard Ceiling	ND Non-Dimming DM01 0-10v, 1% Dimming (Standard) LDE1 Hi-lume 1% EcoSystem LED (Soft fade on, fade-to-black dimming) ECO 1% 0-10v, EldoLED (Logarithmic dimming std) ECDA 1% DALI, EldoLED (Logarithmic dimming std) nLight-Air Acuity nLight Drivers (ECDA driver ONLY) nLight-Wired Acuity nLight Drivers (ECO driver ONLY) SOLO 0.1% 0-10v, EldoLED (Dim-to-dark, Logarithmic dimming std) SODA 0.1% DALI, EldoLED (Dim-to-dark, Logarithmic dimming std) STEP Signify Advance Step Dimming 2WIRE ELV/Forward/Reverse Phase Driver PRUHUES: E10V 2 Channel Color Control EDALI 2 Channel Color Control EDMX ChromaHue or Static White	EMHE CA T20 Emergency Battery (1350 Delivered lumens, CA Title 20 compliant) ETS-DR Iota ETS-DR Emergency Transfer Switch PruTune Wall Device (EDALI driver only, one PruTune device for each zone) SENSORS: (NA w/EDMX) 205 WattStopper PIR Occupancy 205-ON/OFF 205-STEP: Dim to 50% 205-DM: Dim to 1% (NA with DALI) ATHENA Lutron RF (Dim-to-Off Standard) LVOC# Lutron VIVE (Occ & RF) LVRV# Lutron VIVE (RF Only) # Requires Lutron driver NXSMP Hubbell (Occ) rES7 Daylight+ (PIR Acoustic) (Occ) (nLight-Air) Part Number: rES7-PDT-180D-G2 nES7 Daylight+ (PIR Acoustic) (Occ) (nLight-Wired) Part Number: nES-PDT7-ADCC DOWN-LIGHTS: DWNL1 1 Downlight Per Side (4 Total) DWNL2 2 Downlight Per Side (8 Total) (NA 22+33)

Prudential Ltg. reserves the right to change design specifications or materials without notice. Please visit prulite.com for most current data.
© 2026 All rights reserved—All products manufactured at: Prudential Ltg. 1774 E. 21st Street, Los Angeles, CA 90058



Downlights

SERIES	QUANTITY	LOCATION	CCT	DISTRIBUTION	COLOR	VOLTAGE	DRIVERS
DWNLT1 1 Downlight Per Side (4 Total) DWNLT2 2 Downlight Per Side (8 Total) (NA 22+33)	SPECIFY DOWNLIGHT QUANTITY PER FIXTURE/ROW Maximum Two (2) for 2x2 Downlights. Four Downlights all other sizes	MID One Downlight in Middle of each Side MOD Downlight Location(s) per Spec 	LED3-90 3000K-90CRI (Standard) LED35-90 3500K-90CRI LED4-90 4000K-90CRI NOTES: - NA 2700K, 5000K - Only 1 Output Offered	NRW Narrow 20° Beam MED Medium 35° Beam WDE Wide 55° Beam	TMW Textured Matte White (Standard) YGW Gloss White Y__ Premium Color CC Custom Color LUXE METALLICS: YBZ Bronze YCP Copper Penny YGN Gold Nugget	UNV (120-277) 347	DM01 0-10v, 1% Dimming (Standard) LDE1 Hi-lume 1% EcoSystem LED (Soft fade on, fade-to-black dimming) ECO 1% 0-10v, EldoLED (Logarithmic dimming std) ECDA 1% DALI, EldoLED (Logarithmic dimming std) SOLO 0.1% 0-10v, EldoLED (Dim-to-dark, Logarithmic dimming std) SODA 0.1% DALI, EldoLED (Dim-to-dark, Logarithmic dimming std)

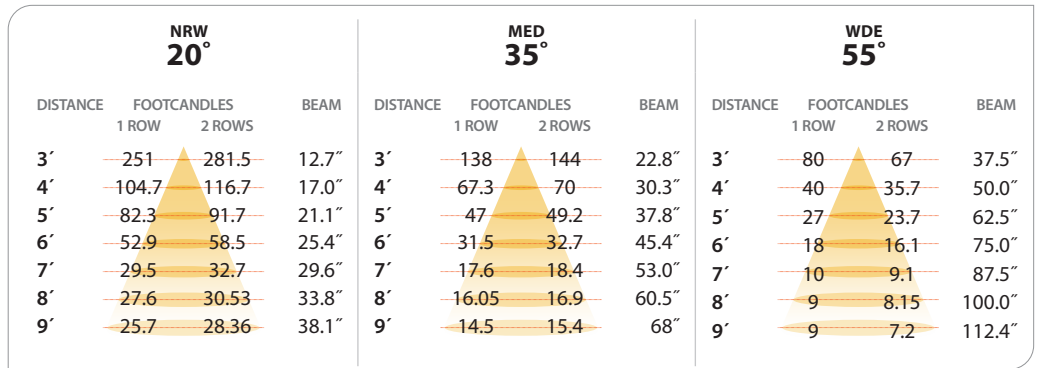
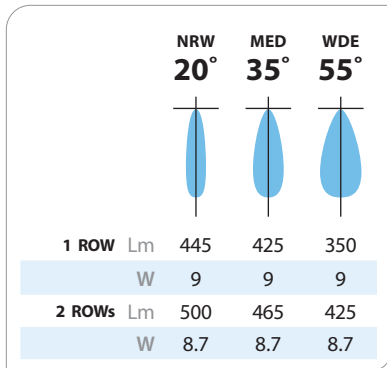

PHOTOMETRICS

LOW OUTPUT:

BPRO5SQ-LIN-(4x4)-LED35-LO

1952 Delivered Lumens

15 Watts

127 lm/w

3500 CCT

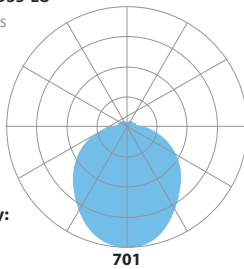

Zonal Lumen Summary:

0-90 (Down) = 100%

90-180 (Up) = 0%

701

Vertical Angle	0°	45°	90°	135°	180°
0°	701	701	701	701	701
5°	695	694	698	697	701
15°	661	663	670	670	673
25°	485	488	491	502	509
35°	522	528	544	543	545
45°	431	436	454	456	455
55°	330	336	353	356	357
65°	226	232	248	252	253
75°	117	126	140	148	146
85°	19	23	39	41	38
90°	0	0	0	0	0

LUMEN MAINTENANCE

L70 — 200,000+ Hours

L90 — 100,000+ Hours (LO, MO & SO)

L90 — 60,000+ Hours (HO)

LED SYSTEM

LED modules and drivers are field replaceable.

PROG

(OPTIONAL)

Programmable light output. Specify desired lumens or watts per linear foot.

LABELS

CSA and ETL damp labeled and I.B.E.W. manufactured.

ELECTRICAL

Must specify LED dimming controls. LED fixtures have constant current driver(s) with less than 20% THD when loaded to a minimum of 60%. Drivers sink a maximum of 6mA per driver. DM01 LED drivers are 0-10V dimmable and are compatible with most 0-10V wall slide dimmers and direct 0-10V analog signal dimmers. Max driver size 1.65" w x 1.25" h.

CONSTRUCTION

Housing

Extruded aluminum housing and side wall >25% PC recycled, 100% recyclable.

Lens

Polymer, 100% recyclable.

Weight

2: 32 lbs **3:** 48 lbs **4:** 64 lbs **5:** 80 lbs

MOUNTING

Surface mounted to ceilings or suspended by cable.

WARRANTY

Single-source, 5 year limited warranty covers standard components and construction.

BionicPro5 Square | Pendant, Surface & Wall



PRUDENTIAL LTG.

PRULITE.COM 213.746.0360

FINISH COLORS

STANDARD:

TMW — Textured Matte White	YGW — Gloss White
----------------------------	-------------------

PREMIUM:

YSW — Seashell White (Matte)	YRG — Rain Grey (Gloss)
YPE — Pewter (Matte)	YSTM — Storm Grey (Matte)
YBK — Black (Matte)	YBB — Black (Semi Gloss)
YSKM — Sky (Matte)	YMB — Military Blue (Matte)
YSAM — Sapphire (Matte)	YIB — Interstate Blue (Matte)
YBR — Bronze (Matte)	YSRM — Sunset Red (Matte)
YOR — Orange (Matte)	YDAM — Daffodil (Matte)
YFGM — Forest Green (Matte)	YSL — Silver (Metallic)
LUXE METALLICS:	
YCP — Copper Penny (Metallic)	YGN — Gold Nugget (Metallic)
YBZ — Bronze (Metallic)	



SPM48", 96" or 144": Square Cast Aluminum Canopy
SPM: (4 Cables)

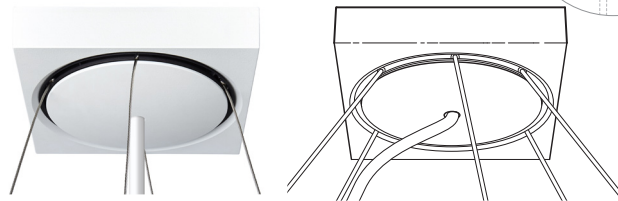

NOTE: Canopies cannot mount directly to t-bar grids

CA Aircraft Cable

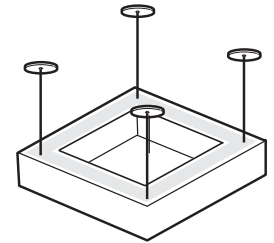

Canopies: 5.5" Wide

Choose from one of our Premium Colors with no set-up fee.

For paint chip samples, please email: info@prulite.com

SPM CANOPY DIMENSIONS

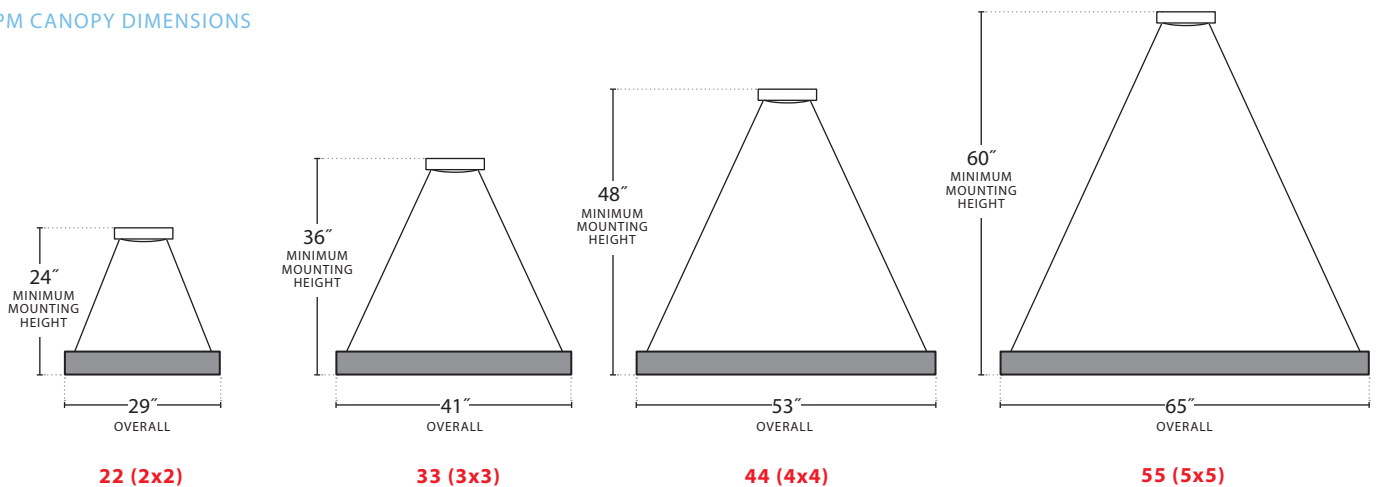



MOUNTING LOCATIONS

- Mounting Points
- ⊕ 7/8" Ø Power Feed

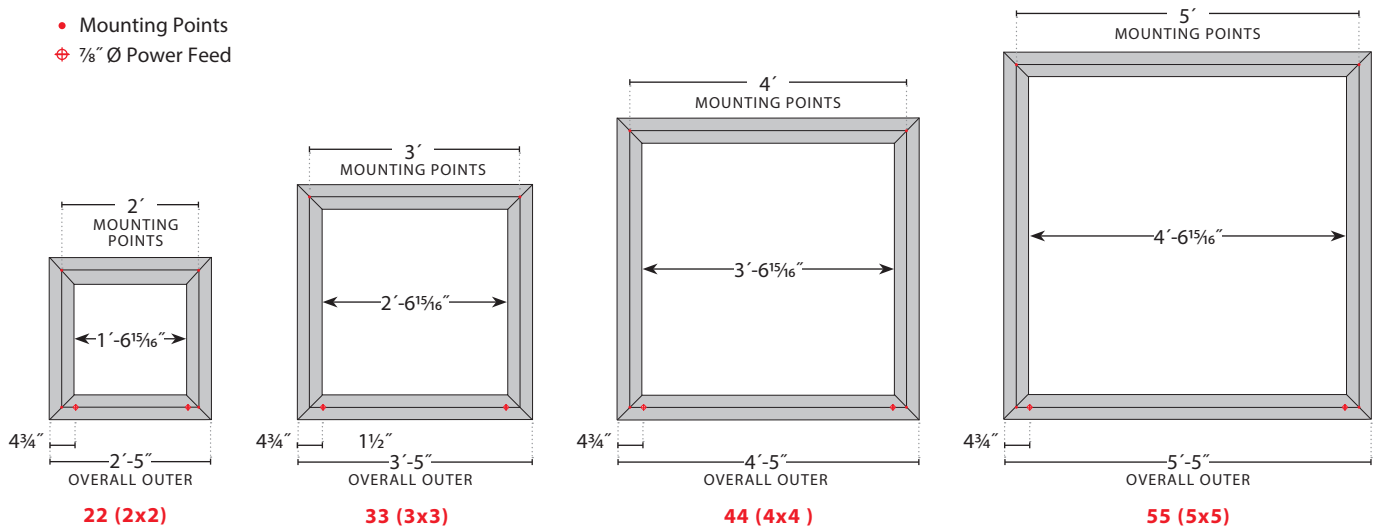

GRID MOUNTING

SUR-X1-ON GRID PARALLEL

2x2 (22)

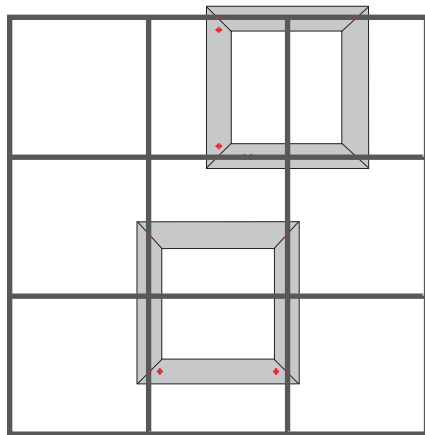

4x4 (44)

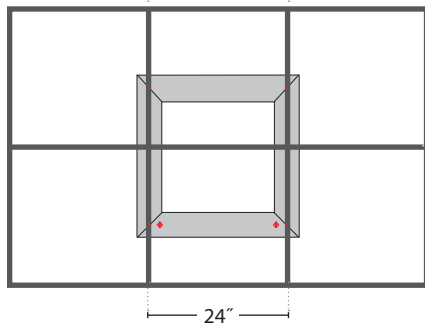
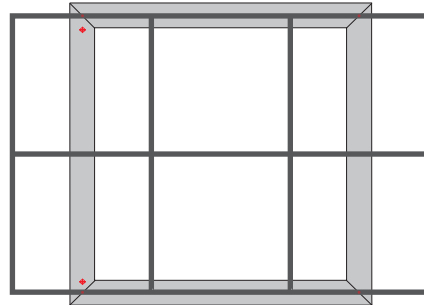

NOTE:

Only available with 22 (2x2) and 44 (4x4) for a standard 2x2 or 2x4 grid system.
 ⊕ Power feeds **CANNOT** be on Grid, **MUST** be over the tile.



SUR-X1-ON GRID DIAMOND

2x2 (22)

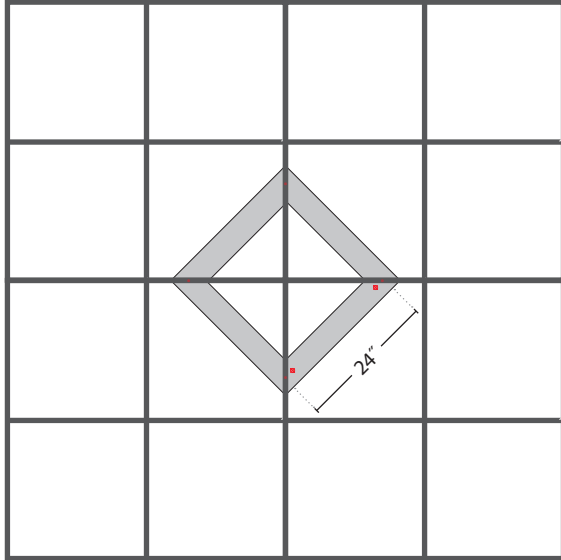

3x3 (33)

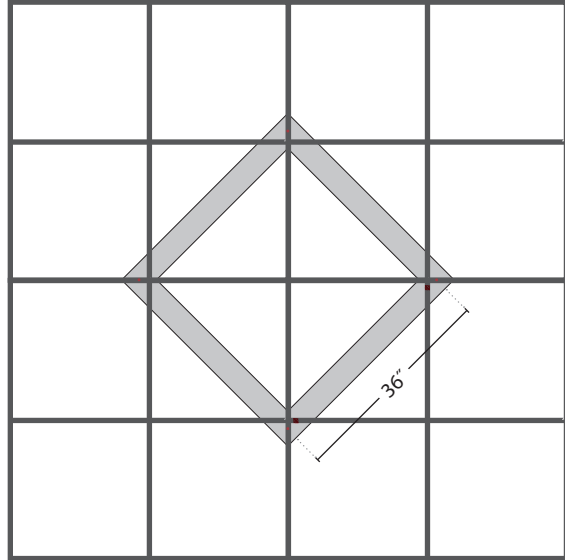

4x4 (44)

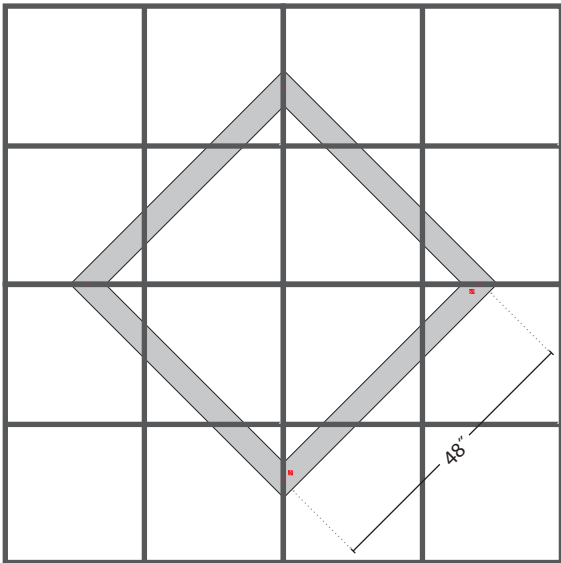

5x5 (55)

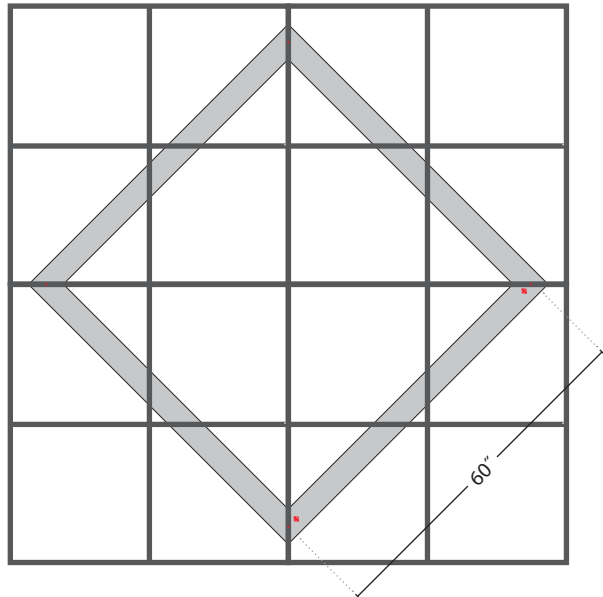



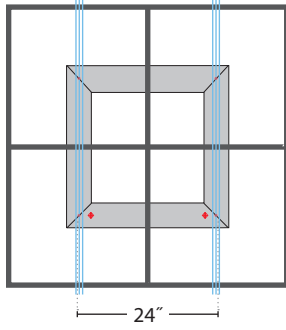

SUR-X1-OFF GRID PARALLEL

2x2 (22)

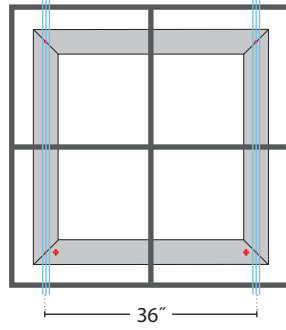

3x3 (33)



 T-bar Mounting Rail Assembly

4x4 (44)

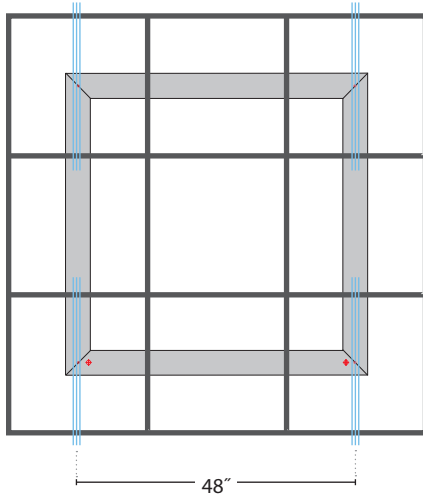

5x5 (55)

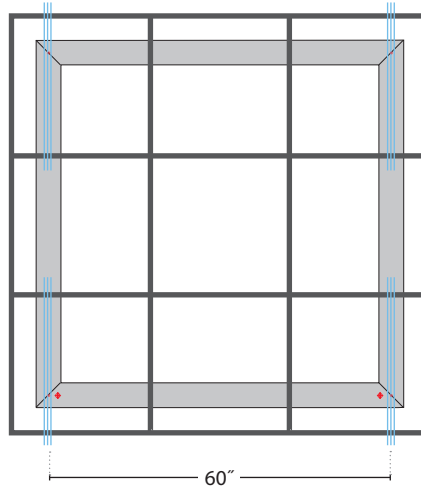



X1-OFF GRID DIAMOND

2x2 (22)*

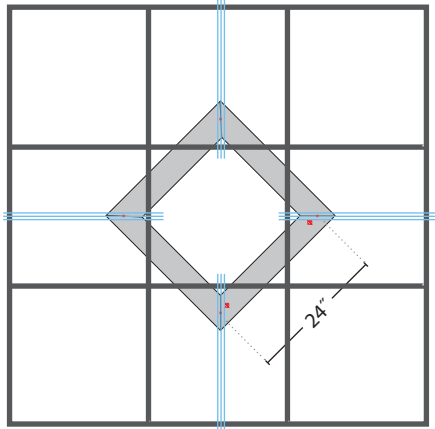

*May need to move the fixture slightly to avoid power feeds interfering with the grid.

3x3 (33)

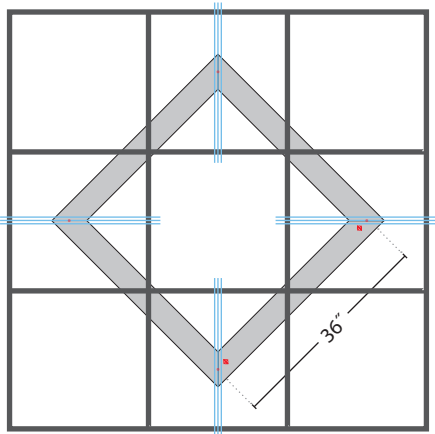

 T-bar Mounting Rail Assembly

4x4 (44)

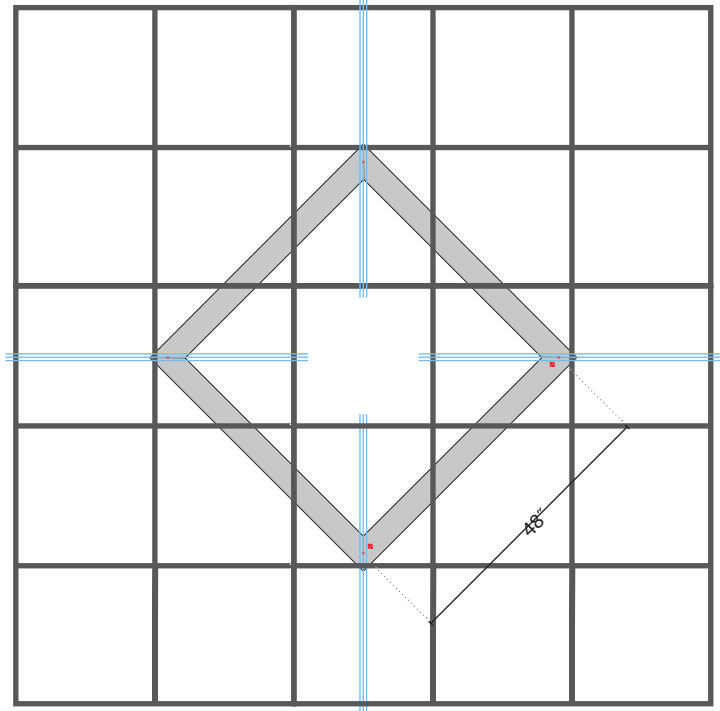

5x5 (55)

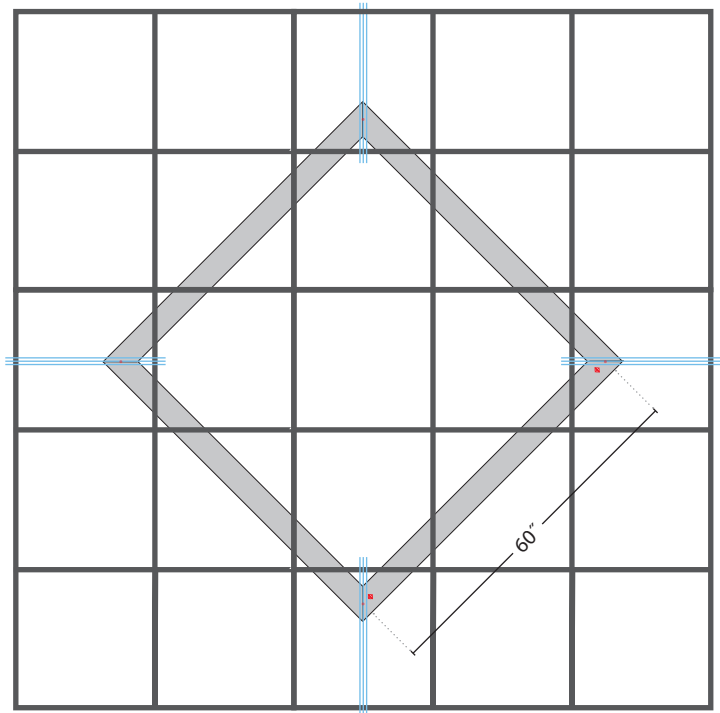



ACOUSTIC COLORS

STANDARD

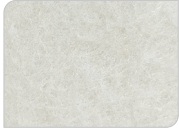

DB05 White

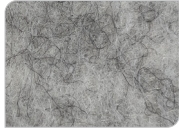

DB03 Marble

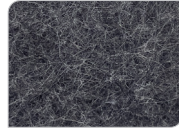

DB33 Grey

PREMIUM (LONGER LEAD TIMES)



DB01 Sand Dollar

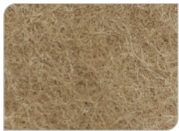

DB02 Oat

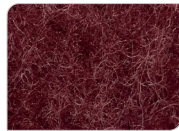

DB18 Maroon

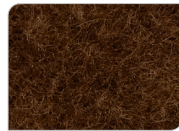

DB28 Hickory



DB29 Brown

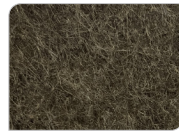

DB30 Earth Brown

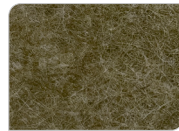

DB32 Stone

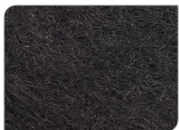

DB34 Charcoal

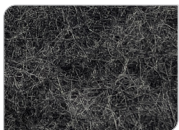

DB35 Pepper

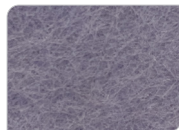

DB06 Periwinkle

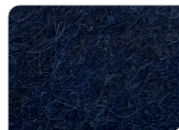

DB31 Blue Jean

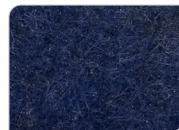

DB26 Midnight Blue



DB27 Teal



DB24 Sky Blue

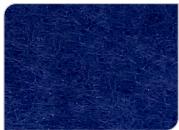

DB25 Navy

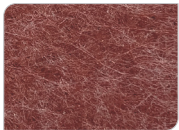

DB11 Berry



DB10 Red

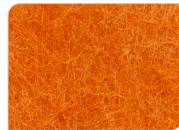

DB16 Orange

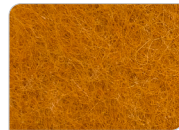

DB17 Pumpkin

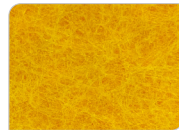

DB09 Yellow

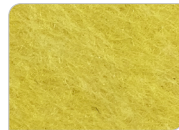

DB08 Lemon



DB20 Lime

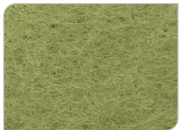

DB19 Pear

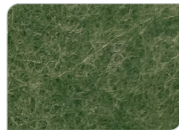

DB21 Green

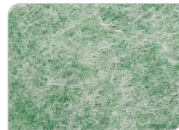

DB22 Heather Green

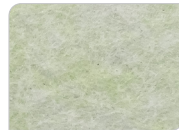

DB23 Honey Dew

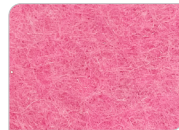

DB12 Pink



DB07 Salmon

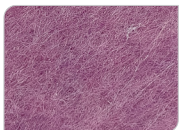

DB13 Lilac

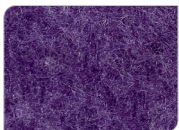

DB14 Violet

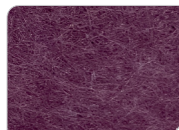

DB15 Purple

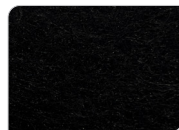

DB36 Black

Consult factory for Premium Color acoustic lead times.

CROSS SECTION

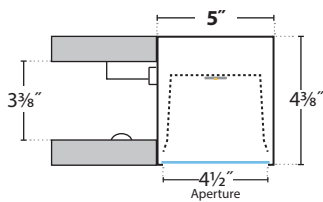

Two layers of acoustic with 3 3/8" air gap for better sound absorption.

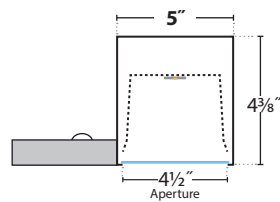

One layer acoustic for Surface Mounted.



PRULITE ACOUSTIC CALCULATOR

How many Acoustic fixtures should you choose for your space? There are multiple factors when calculating acoustics, we have done our best to provide a simple guide for those who prefer not to calculate using Sabins per Object or NRC ratings.

1) Calculate the square feet of your space (L x W).

2) Choose the amount of acoustical improvement you want (sound absorption for reduced reverberation) and find the Acoustic VALUE based on room dimensions.

Estimated % of reduced reverberation time	SIZE	Room dimensions under 300 sq ft			Room dimensions over 300 sq ft		
		GOOD 👍	BETTER 👍👍	BEST 👍👍👍	GOOD 👍	BETTER 👍👍	BEST 👍👍👍
👍 GOOD 25%	24" Square Acoustic	30	20	15	40	30	20
👍👍 BETTER 37.5%	36" Square Acoustic	40	30	25	60	40	30
👍👍👍 BEST 50%							

Calculations based on a 9' ceiling height.
Prudential Lighting Acoustic Calculator is a guide.
For precise acoustic performance, please consult an acoustician.

3) Use this Acoustic VALUE Formula to determine the number of luminaires recommended:

Square feet / Acoustic VALUE = # of luminaires recommended

Example:

20' x 30' = **600** square feet

36" BionicPro Square Acoustics seeking Better (~37.5% reduced reverb), Acoustic VALUE = **40**

600 / 40 = 15 BionicPro Square Acoustics recommended for the space

NOTE: We are testing BionicPro Acoustical fixtures. this data is from our Gaze Square Acoustical fixtures which should be comparable.



SOUND ABSORPTION

Why acoustical fixtures?

Open office, open ceilings, hard floors have replaced sound absorbing cubicles, acoustic ceilings and carpet, thus acoustics have declined, enter Acoustics.

The benefits of Acoustics?

- Reduced echoes, background noise
- Improved sound quality
- A more peaceful space
- Enhanced aesthetics

How can I calculate Acoustic sound absorption?

Sabins per object is the standard measurement. One Sabins is approximately 1ft² of sound absorption. Sound absorption varies at different frequencies.

For precise acoustic performance of a space, please consult an acoustician.

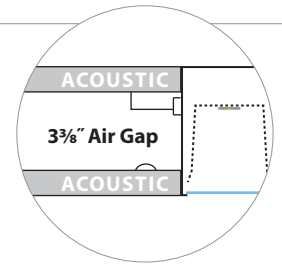

Two layers of acoustic with 3 3/8" air gap for better sound absorption.

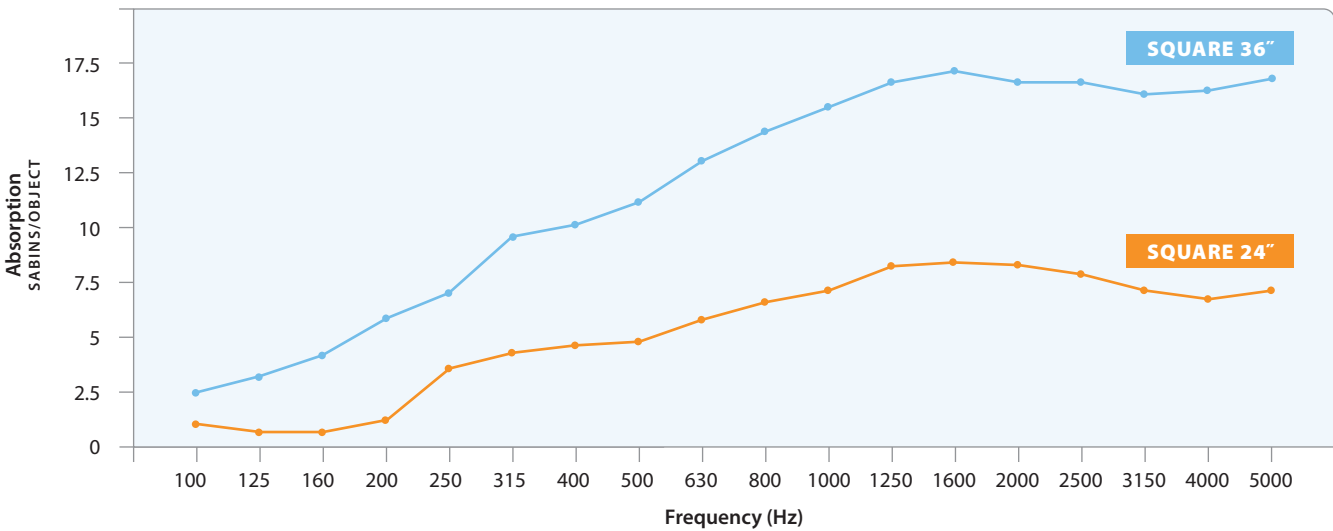

What is an NRC rating?

Noise Reduction Coefficient (NRC) is a rating for how much sound a surface absorbs according to the test method ASTM C423. Acoustic performance is measured using this rating. NRC is the average Sabins per square foot of surface covered. Apparent NRC (A-NRC) Ratings are calculated from the total Sabins measured for an object array over an area of projected continuous ceiling. This is equivalent to ceiling tile of the same NRC rating over the same installed area.

NRC ratings range from 0 to 1+

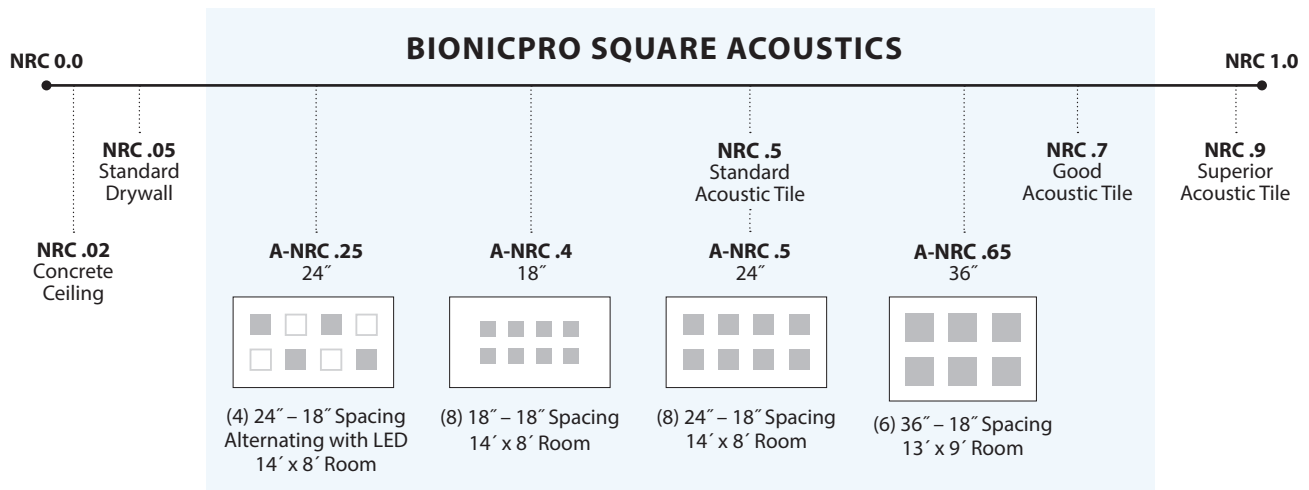



Lumen Outputs:

		BluHue, TuHue, TuHue2, AmberHue			
DIRECT:		LO	MO	SO	HO*
	SAL Lm/Ft	205	385	550	715
	W/Ft	3.8	5.6	7.8	10.5

* TU2 + AMB Not Available HO / CHROMAHUE ONLY AVAILABLE ON HO



Prudential Lighting's **TuHue** Tunable White provides warm to cool white light simulating sunlight. Controlling the light source color temperature offers differing design aesthetics with potential benefits via circadian rhythm support. Blue light for alertness while warm light conveys tranquility.

- 2700K-6500K or 2200K-5000K.
- Adjust the color temperate and brightness separately.
- Simulates warm to cool to warm transition of sunlight.

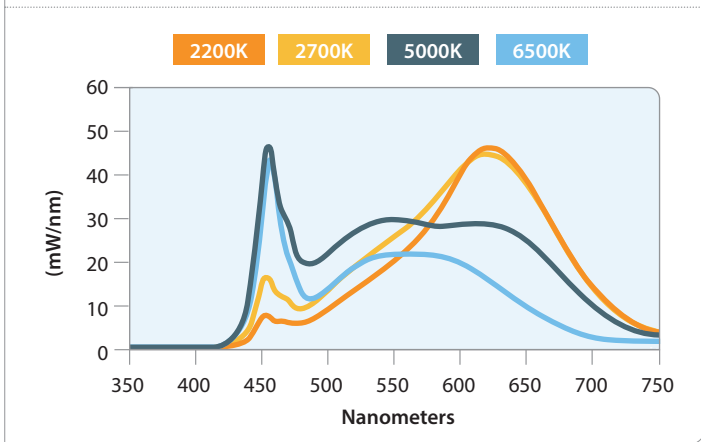
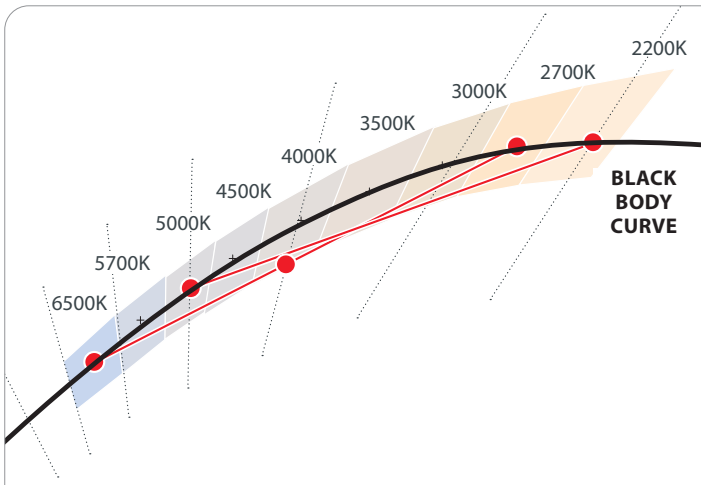

BluHue BIOS SkyBlue™ circadian LED lighting brings the benefits of blue skies inside. Newly discovered blue-sky receptors in our eyes drive improved daytime alertness, mood, brain function, and strengthens circadian rhythms leading to overall better health and well-being.



- Circadian rhythms play an integral role in physical and mental health.
- BluHue BIOS SkyBlue pinpoints peak 490nm sensitivity to provide the most benefit from an electric light source.
- At night, simply dim the lights to remove SkyBlue™ wavelengths (specify "Blu_D" to dim Cyan SkyBlue spike separately [night mode]).

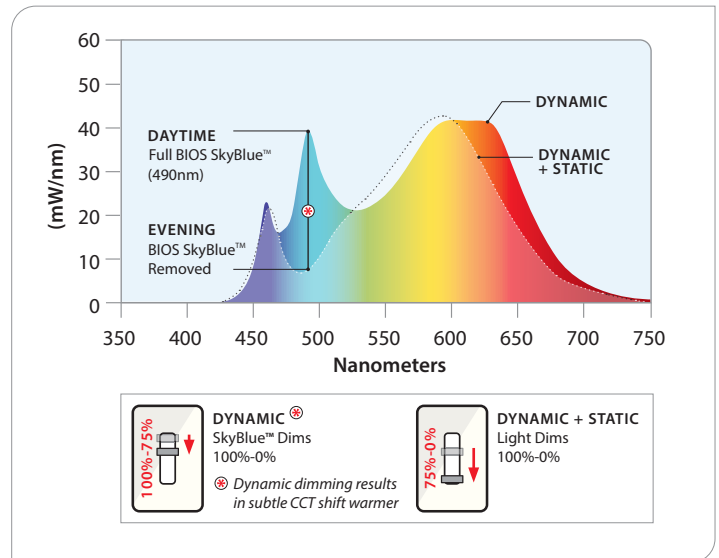

AmberHue is Prudential Lighting's Warm Dim offering. It transitions bright white light to warm amber light as brightness is dimmed, reflecting sunlight's transitioning from intense blue midday light to a dimmed golden hue near sunset, also reminiscent of soft glowing candlelight.

- Warm Dim 2200K-5000K.
- Color temperature warms as the luminaire is dimmed.
- Calm, relaxing mood communicated – hospitality, residential feel.

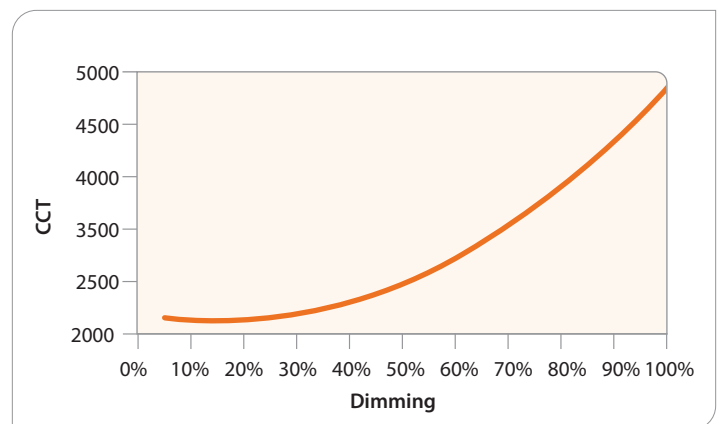



ChromaHue offers a vibrant full gamut of colors for seemingly endless architectural interior applications. Rich color-changing light offers tremendous design flexibility while white light can be achieved with the White chip, or mixing of Red, Green and Blue light. No longer just for the entertainment industry, ChromaHue can be intermixed on BionicPro luminaires for mood-creating indirect illumination combined with static white direct light.

- RGBW LED array (Red, Green, Blue, White) with full spectrum color and white light on the black body curve.
- Four-channel control, DMX drivers.
- Any color point within the triangle can be reached by setting the proper output levels for each individual red, green, blue and white channels.
- Standard DMX is one zone with one XLR drop at start, one XLR return at the end.

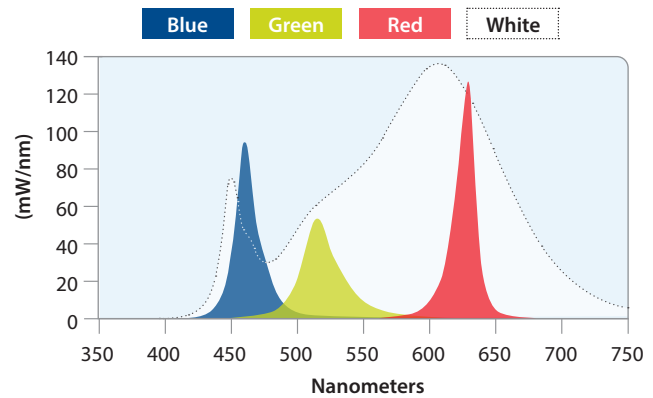
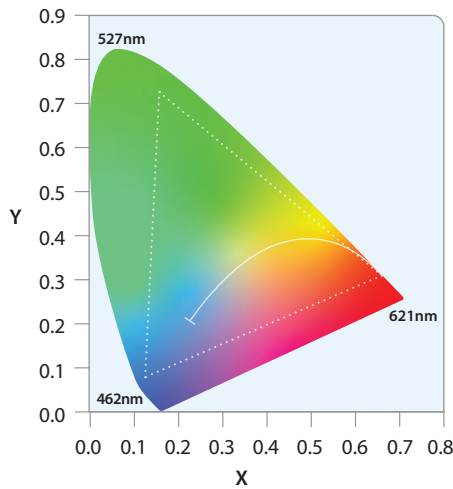

CONSTRUCTED WHITES

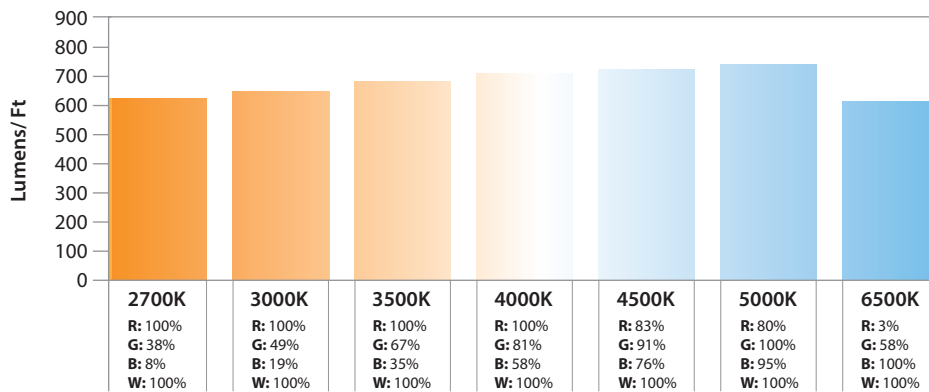



PRUTUNE WALL DEVICE

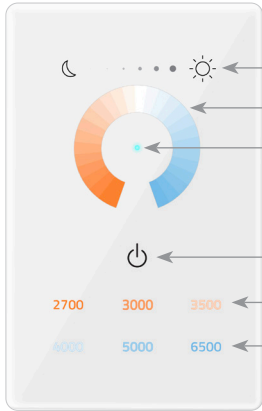

BRIGHTNESS: 0.1%-100%

COLOR WHEEL

POWER INDICATOR
RED : OFF
BLUE : ON

ON / OFF

PRESET COLOR TEMPERATURES

PRUTune DALI device includes:

- Easy-to-understand user control with intuitive design
- Out-of-the-box set-up, no commissioning needed
- Color wheel for color change from 2700K to 6500K
- Dimming to 0.1% (255 Steps)
- Six preset colors (2700K, 3000K, 3500K, 4000K, 5000K, 6500K)
- Must use DALI driver, consult factory to control non-Prudential Ltg Tunable White fixtures
- Control one (1) zone - up to 30 drivers
(Consult factory for fixture quantity dependant upon fixture type, size & output)

PRUTune + EMHE: — Prutune does not have memory

- Once normal power is restored, the controller sends a signal of 100% intensity and 6500K CCT

EXPLODED VIEW

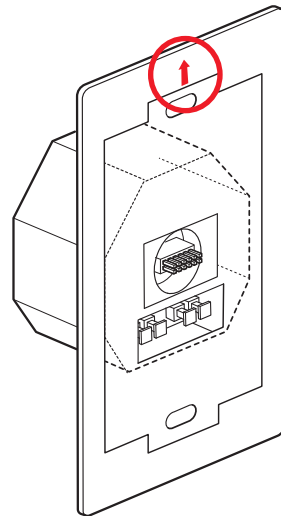
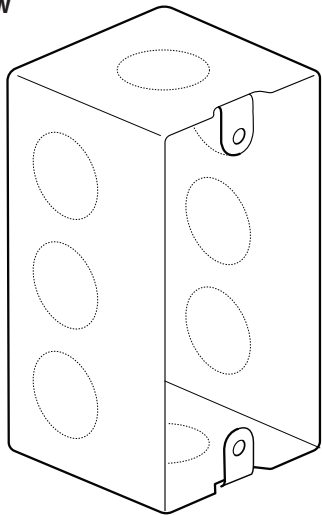

Ensure arrows are aligned when assembling 'Pru wall device'



BionicPro5 Square | Pendant, Surface & Wall



PRUDENTIAL LTG.

PRULITE.COM 213.746.0360

LM79 & TM30 DATA:

	MEASURED CCT	MEASURED LUMENS	CRI	R9	DuV	SPD	TM30 — COLOR VECTOR	TM30 — COLOR DISTORTION
LED27	2680	80%	93	58	0.001		89 Rf	97 Rg
LED3	3042	95%	82	6	0.001		81 Rf	92 Rg
LED3-90	3016	85%	93	61	0.000		88 Rf	96 Rg
LED35	3482	100%	82	3	0.002		81 Rf	92 Rg
LED35-90	3417	85%	93	67	0.000		88 Rf	96 Rg
LED4	3952	102%	82	4	0.003		81 Rf	92 Rg
LED4-90	3882	85%	92	67	0.003		87 Rf	96 Rg
LED5-90	4889	85%	94	84	0.002		86 Rf	95 Rg



LM79 & TM30 DATA:

		MEASURED CCT	MEASURED LUMENS	CRI	R9	LED27	SPD	TM30 — COLOR VECTOR
BH3S&D	bios 3000K	2779	2758	87	81	0.003		
	BH3D SKY BLUE DIMMED	2715	2425	82	3	0.002		
BH35S&D	bios 3500K	3245	2919	85	87	0.003		
	BH35D SKY BLUE DIMMED	3061	2502	83	7	0.001		
BH4&D	bios 4000K	3624	2993	85	86	0.004		
	BH4D SKY BLUE DIMMED	3388	2585	83	5	0.002		
TH	LED27	2684	2456	92	57	0.0001		
	LED65	6061	3292	82	-1	0.006		
TH2	LED22	2209	2112	92	52	0.0005		
	LED50	4796	2789	93	77	0.004		
CH	2700K	2632	2469	82	50	0.003		
	3500K	3388	2585	83	5	0.002		
	4000K	3977	2682	83	29	0.003		
	5000K	5233	2823	84	21	0.003		



SENSORS

				
<p>205: Wattstopper</p> <p>Low voltage PIR fixture integrated occupancy sensor.</p>	<p>LVOC: Lutron Occupancy /Daylight Sensor</p> <p>Measures light in the space (daylighting) while detecting people moving within an area using passive infrared to determine occupancy.</p> <p>Controls the lights to balance the light level in the space, combining convenience, exceptional energy savings, and ease of installation.</p>	<p>LVRF: Lutron Vive Control Node</p> <p>Provides wireless control of the fixture when neither occupancy nor daylight sensing is needed.</p>	<p>NXSMP: Hubbell Occupancy /Daylight Sensor</p> <p>Hubbell Integrated/embedded networked lighting control, luminaire-level lighting control, LLLC.</p> <p>PIR motion sensor for automatic On/Off control.</p> <p>Integrated daylight sensor for daylight harvesting and/or lumen maintenance.</p> <p>Bluetooth radio provides wireless control of luminaire.</p> <p>Simple plug-in connection to NX Fixture Modules.</p> <p>Wireless Internet.</p>	<p>ATHENA</p> <p>The Athena wireless node is a radio frequency (RF) device that enables simple, digital control of individual light fixtures in an Athena control system.</p> <p>The small size and compatibility with a wide variety of drivers allow for seamless integration with common commercial lighting fixtures from any manufacturer.</p> <p>Requires drivers with auxiliary power, consult factory for lead times</p>
				
<p>NLT-AIR-rIO: Daylight+Occ</p> <p>The rIO is a fixture embedded low voltage wireless nLight AIR device capable of individual fixture control and analog or digital dimming. This smart device results in the luminaire being “nLight AIR-enabled” — making it an addressable nLight AIR device. It uses a 900MHz radio to communicate with other nLight AIR devices, such as occupancy sensors, photocells, wall switches, powerpacks and other nLight AIR-enabled luminaires. This allows for advanced operation and design flexibility ranging from stand-alone rooms to building and campus-wide networks.</p>	<p>NLT-AIR-ADCX: Daylight+(PIR Acoustic) Occ</p> <p>The nLight® AIR rES7 sensor is an in-fixture, low voltage, digital sensor providing embedded wireless lighting control, analog or digital dimming, occupancy detection and daylight harvesting capabilities.</p> <p>The rES7 is designed for mounting heights up to 20 ft in indoor luminaires. The rES7 sensor provides Passive Infrared (PIR) occupancy detection over a 15-20 ft (4.57 - 6.10 m) radial coverage pattern and photocell light level detection in one compact low profile design with optional Dual Technology, which adds Microphonics™ to PIR detection. The rES7 sensor is ideal for occupancy and daylighting control in suspended or recessed luminaires.</p>	<p>NLT-WIRED-nIO: Daylight+Occ</p> <p>nLight digital nIO modules are low voltage control devices that enable digital control of LEDcode enabled eldoLED LED drivers. Through eldoLED's bi-directional 2-wire interface, these modules deliver natural, flicker-free high performance dimming while eliminating common issues related to 0-10 VDC alternatives. The modules also enable the eldoLED LED Drivers to be addressable, as well as capable of digitally communicating with other nLight controls such as occupancy sensors, photocells, and WallPods. This allows for advanced operation and design flexibility ranging from stand-alone rooms to building and campus-wide networks.</p>	<p>NLT-WIRED-ADCX: Daylight+(PIR Acoustic) Occ</p> <p>The nES7 is a small passive infrared occupancy sensor designed to be easily embedded into luminaires. This sensor provides excellent line of sight 360° PIR detection of small motion and walking motion. The nES7 is ideal for small rooms without obstructions or areas with primarily walking motion (e.g. corridors, library stacks). Additionally, an optional integrated photocell enables daylight harvesting control as well. Typically one or more nES7 sensors are paired with an nLight controller within an nLight enabled luminaire.</p> <p>For rooms like classrooms and private offices or any space with obstructions, the nES PDT 7 dual technology sensor is recommended.</p>	