

BionicPro5 | Recessed Linear Light Pocket — X3 (Hard Ceiling)



ROW INSTRUCTIONS

BPRO5-REC-FLSH-LP-X3-SC (NON-NOMINAL LENGTHS)

GENERAL SPECIFICATIONS

- **DRIVER:** UL recognized electronic drivers. DM01 = 0-10v 1% Dimming. ND = NON-DIMMING.
- **FIXTURE INPUT WATTS PER 4' SECTION =** LO = 15w, MO = 22w, SO = 31w, HO = 42w.
- **SC** = Single Circuit.
- **EMHE** = Emergency Battery Pack (CA Title 20 compliant)
- **IC RATING:** Fixtures are IC Rated unless Insulation Detector is factory-installed. (Insulation Detector requires 120 or 277 voltage).
- **LABELS:** ETL LED luminaires (conforms to UL 1598).
- **FINISH (POWDER COAT):** TMW = Textured Matte White. YGW = Gloss White. YSL = Silver (Metallic). YBK = Black (Matte).
- **LED BOARDS:** LED27 = 2700K, LED3 = 3000K, LED35 = 3500K, LED4 = 4000K, LED5 = 5000K (-90 = 90CRI).
- **REFLECTORS:** Die-formed #24 GA. White Optics M16.
- **LENS:** Composite polymer. SAL = Satin Acrylic, BTW = Batwing.
- **HOUSING:** Die-formed #20 GA. cold rolled steel.
- **CIRCUIT ASSEMBLY:** Prudential Ltg. reserves the right to change Circuit Assemblies from #16 gauge to #12 gauge, as needed.

NOTES

- Seamless composite lens is shipped rolled in bulk, contractor to cut to size and install.
- All dimensions shown include (2) 1/2" thick finish plates.
- Individual fixtures not intended for continuous row mounting.
- Symbol  indicates emergency fixture location.
- Submittal drawings are used for review purposes only. (Go to prulite.com for installation instructions).

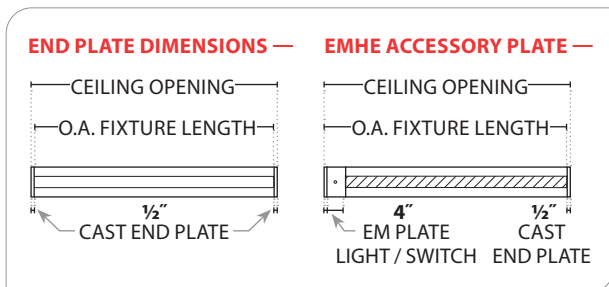

CROSS SECTIONS

SEE SPEC SHEET FOR ADDITIONAL HARD CEILINGS

X3 —

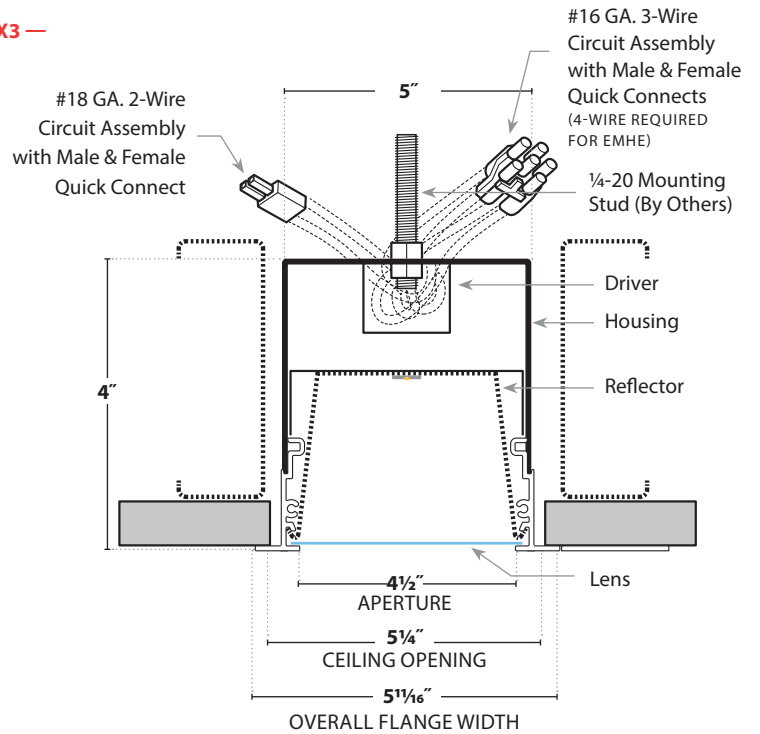

INSULATION DETECTOR / EMHE —

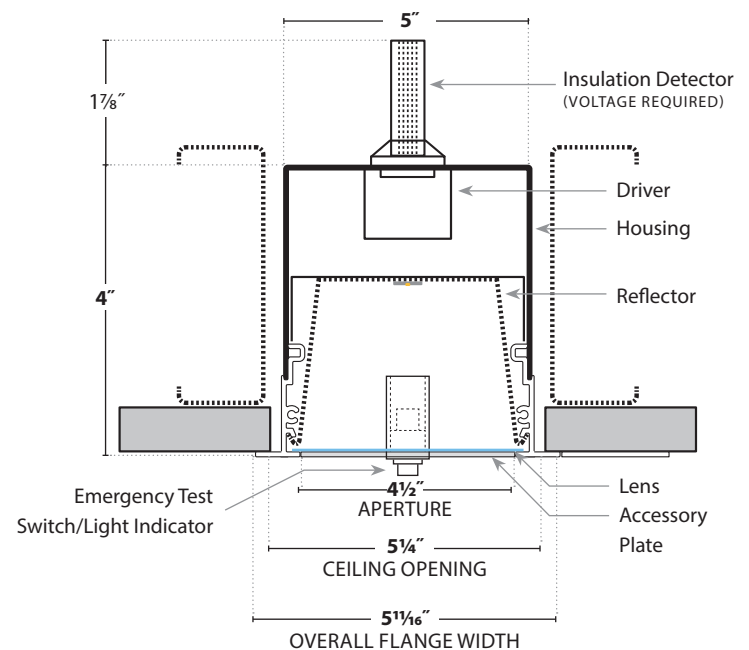

WARNING: Ground fixture in accordance with local and national electrical codes. Failure to do so may result in serious personal injury. Fixture Installations should ONLY be done by a qualified licensed electrical professional.

BionicPro5 | Recessed Linear Light Pocket — X3 (Hard Ceiling)

ROW INSTRUCTIONS

**BPR05-REC-FLSH-LP-X3-SC
(NON-NOMINAL LENGTHS)**

TO REQUEST EMERGENCY FIXTURES:

- Use the fixture number (shown here in red) 17' row with EMHE on Fixtures 1 and 3.
OR
- Print out layout and circle where emergency is needed and send in with your order.

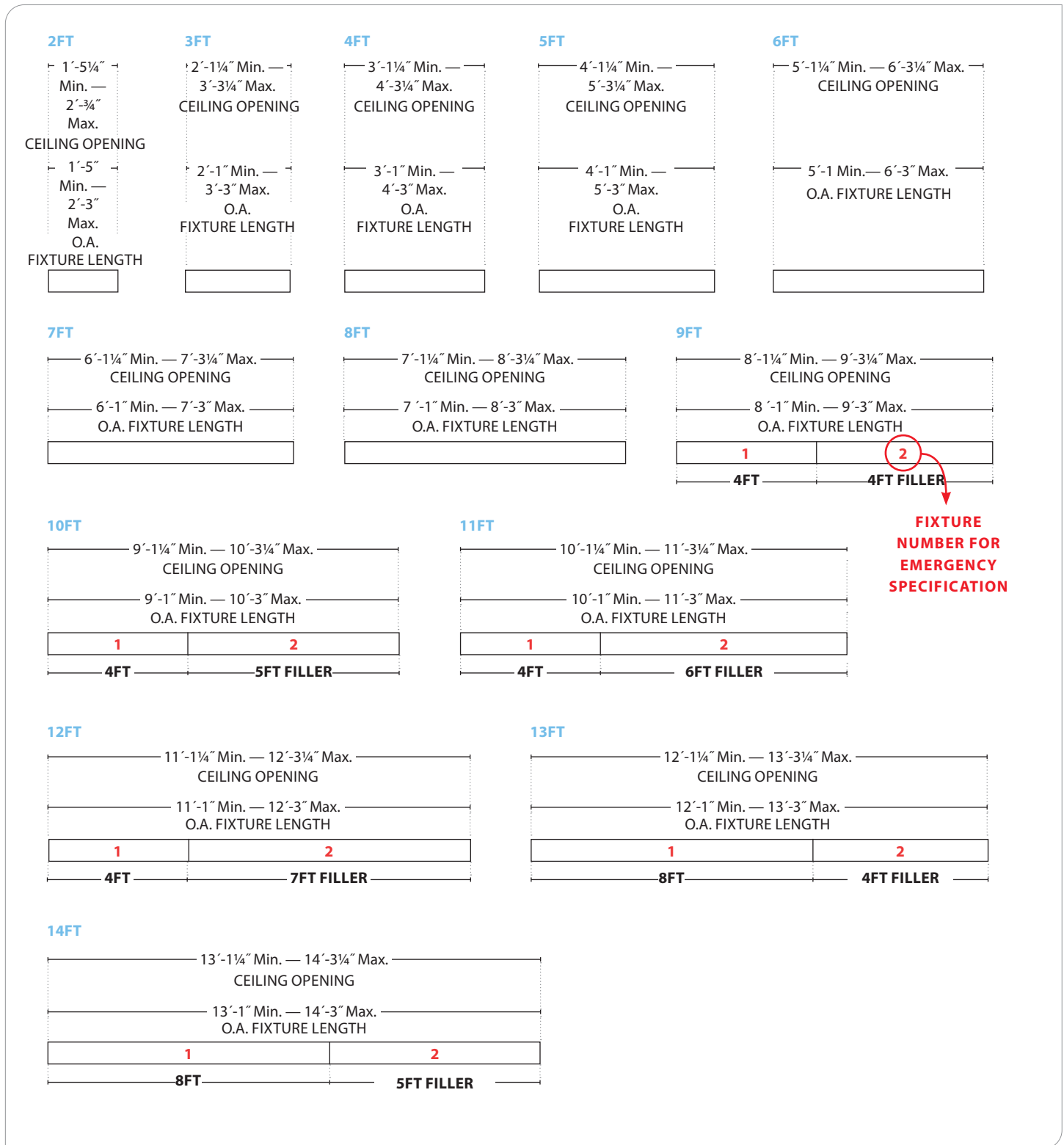

WARNING: Ground fixture in accordance with local and national electrical codes. Failure to do so may result in serious personal injury. Fixture installations should ONLY be done by a qualified licensed electrical professional.

BionicPro5 | Recessed Linear Light Pocket — X3 (Hard Ceiling)

ROW INSTRUCTIONS

BPRO5-REC-FLSH-LP-X3-SC (NON-NOMINAL LENGTHS)

15FT

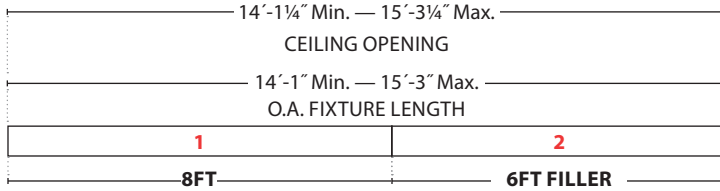

16FT

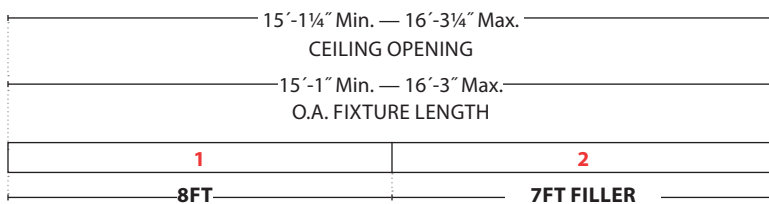

17FT

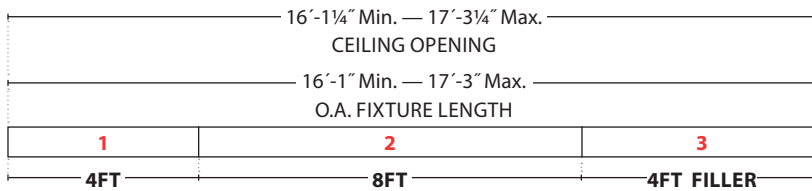

18FT

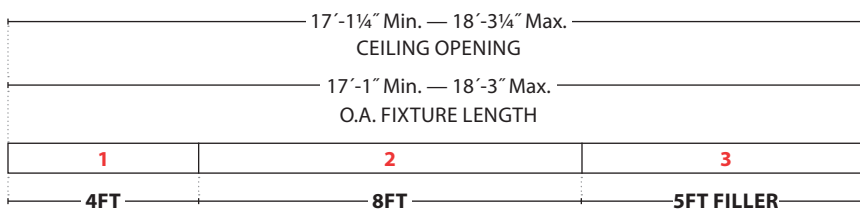

19FT

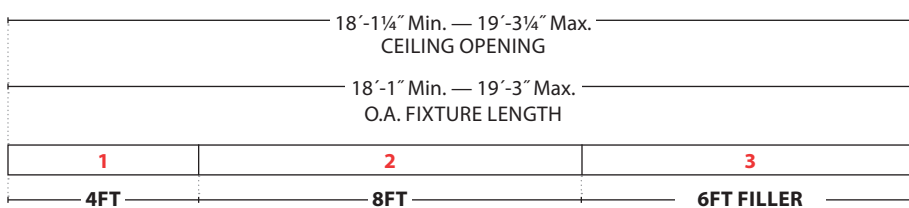

WARNING: Ground fixture in accordance with local and national electrical codes. Failure to do so may result in serious personal injury. Fixture Installations should ONLY be done by a qualified licensed electrical professional.

BionicPro5 | Recessed Linear Light Pocket — X3 (Hard Ceiling)

ROW INSTRUCTIONS

BPRO5-REC-FLSH-LP-X3-SC (NON-NOMINAL LENGTHS)

20FT

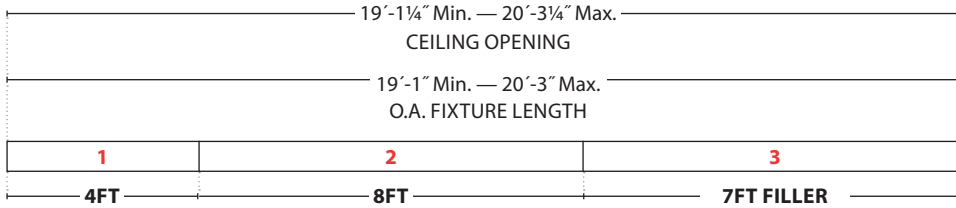

21FT

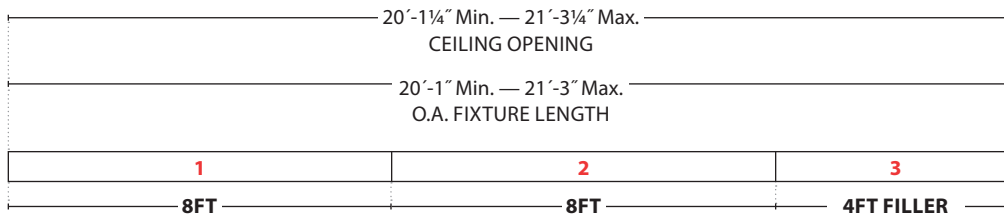

22FT

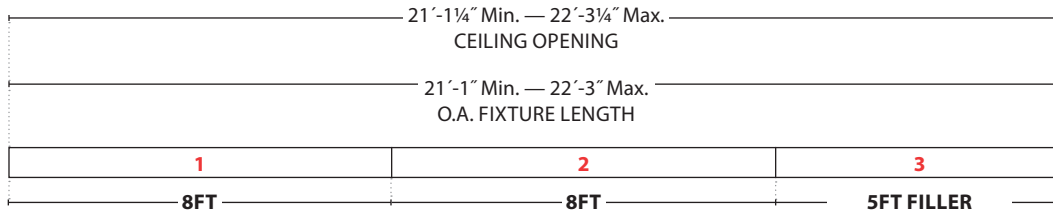

23FT

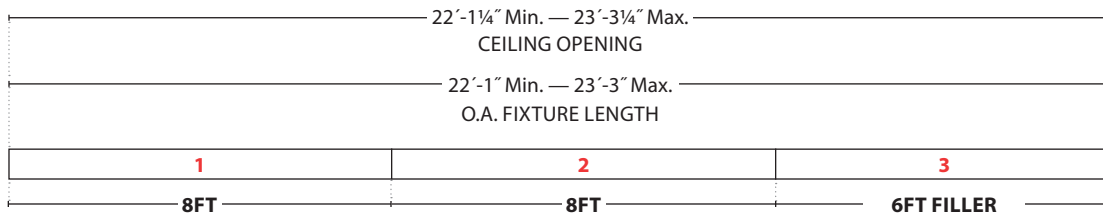

24FT

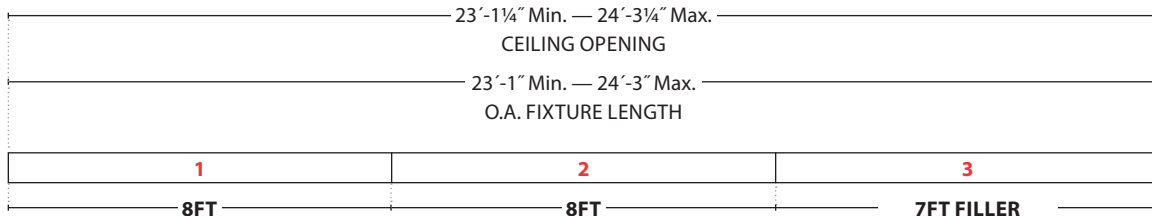

WARNING: Ground fixture in accordance with local and national electrical codes. Failure to do so may result in serious personal injury. Fixture Installations should ONLY be done by a qualified licensed electrical professional.

BionicPro5 | Recessed Linear Light Pocket — X3 (Hard Ceiling)

ROW INSTRUCTIONS

BPR05-REC-FLSH-LP-X3-SC (NON-NOMINAL LENGTHS)

25FT

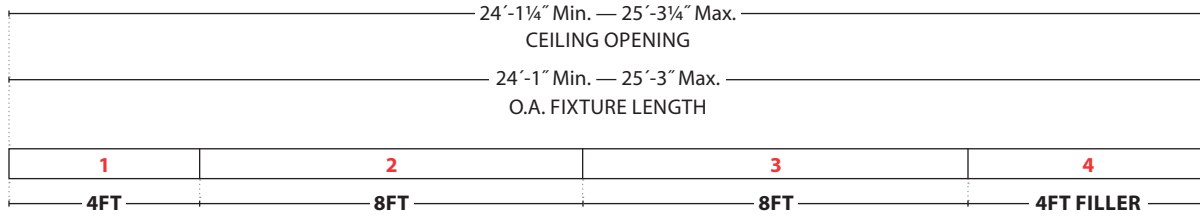

26FT

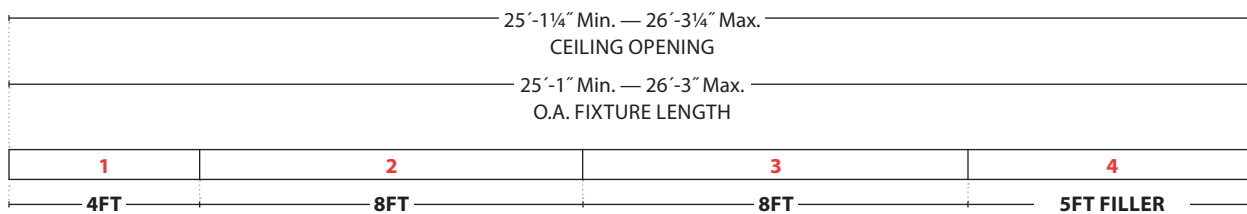

27FT

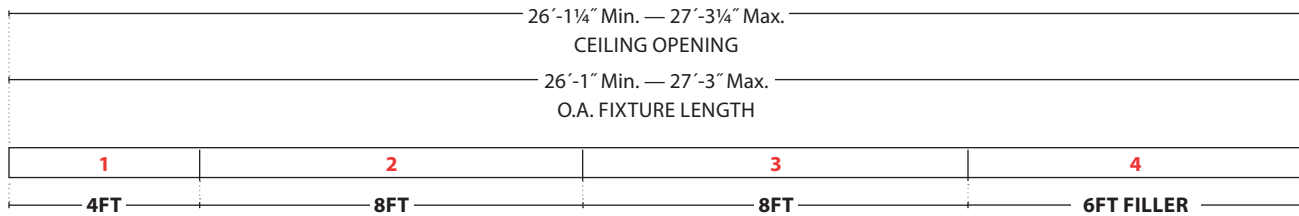

28FT

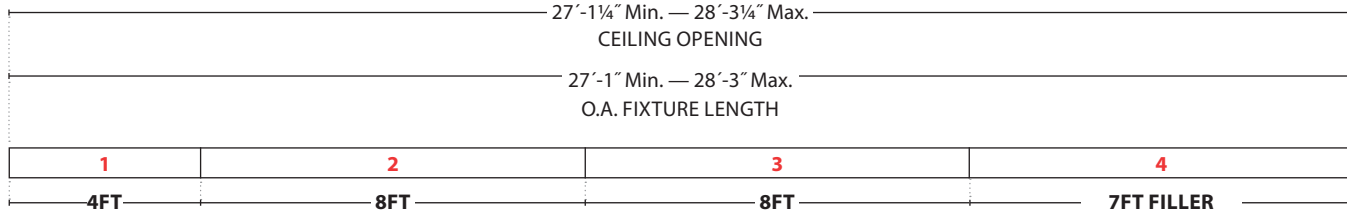

29FT

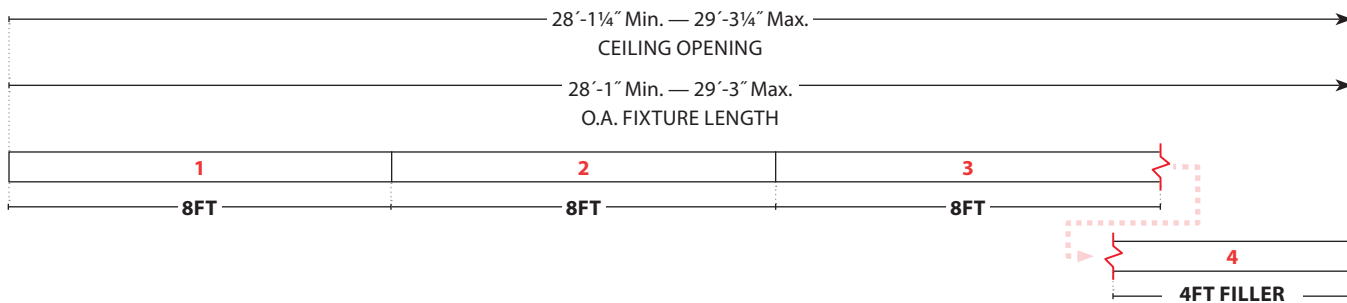

WARNING: Ground fixture in accordance with local and national electrical codes. Failure to do so may result in serious personal injury. Fixture Installations should ONLY be done by a qualified licensed electrical professional.

BionicPro5 | Recessed Linear Light Pocket — X3 (Hard Ceiling)

ROW INSTRUCTIONS

**BPRO5-REC-FLSH-LP-X3-SC
(NON-NOMINAL LENGTHS)**

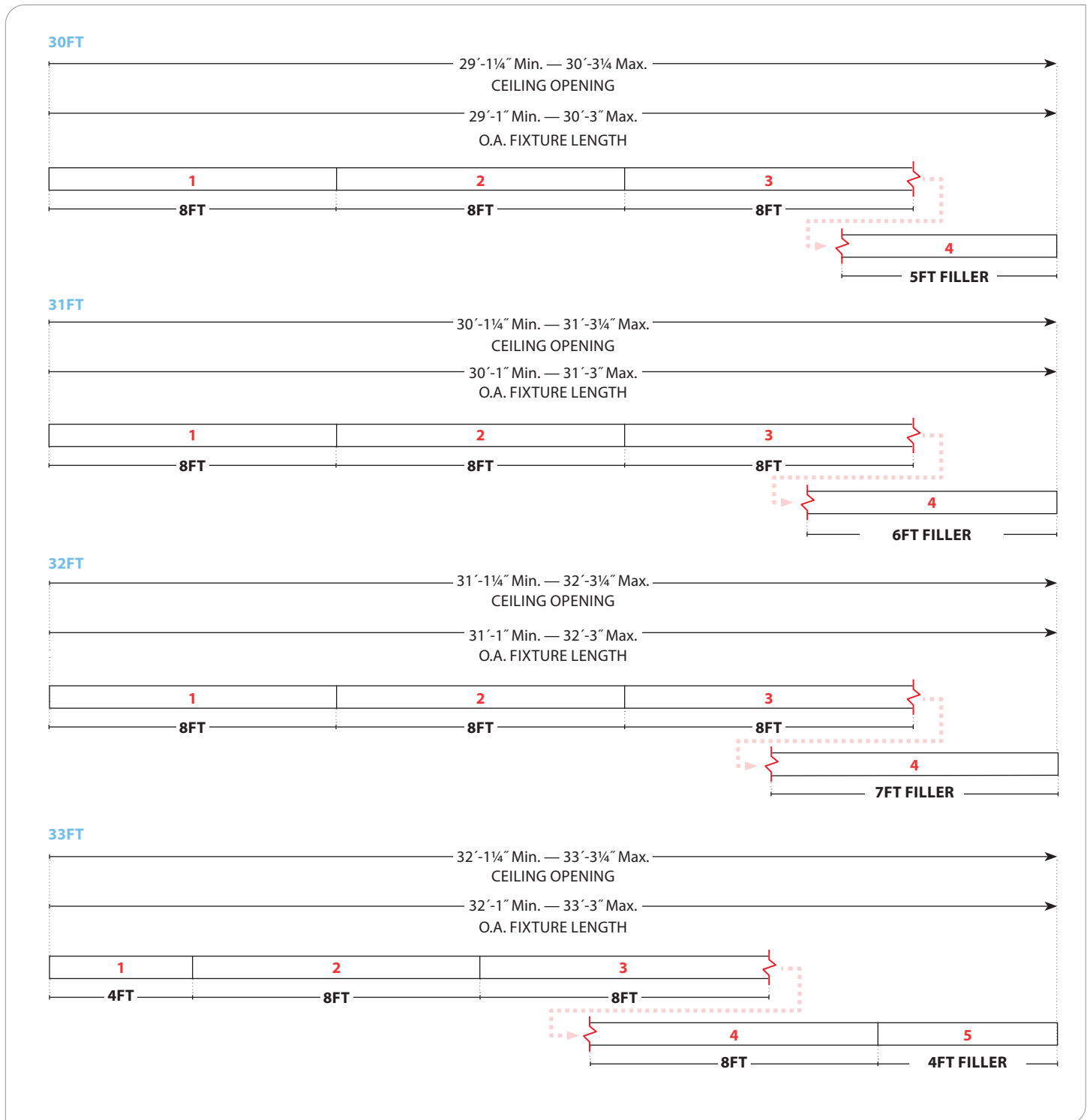

WARNING: Ground fixture in accordance with local and national electrical codes. Failure to do so may result in serious personal injury. Fixture installations should ONLY be done by a qualified licensed electrical professional.

BionicPro5 | Recessed Linear Light Pocket — X3 (Hard Ceiling)

ROW INSTRUCTIONS

BPRO5-REC-FLSH-LP-X3-SC
(NON-NOMINAL LENGTHS)

34FT

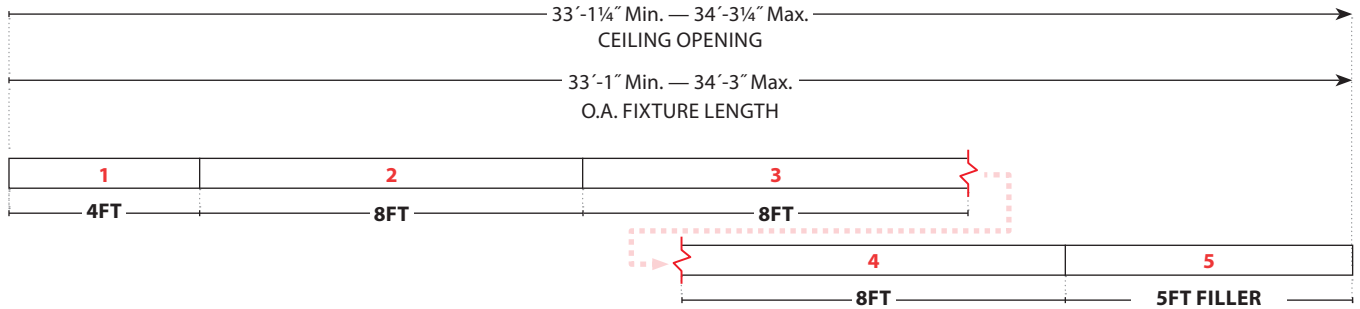

35FT

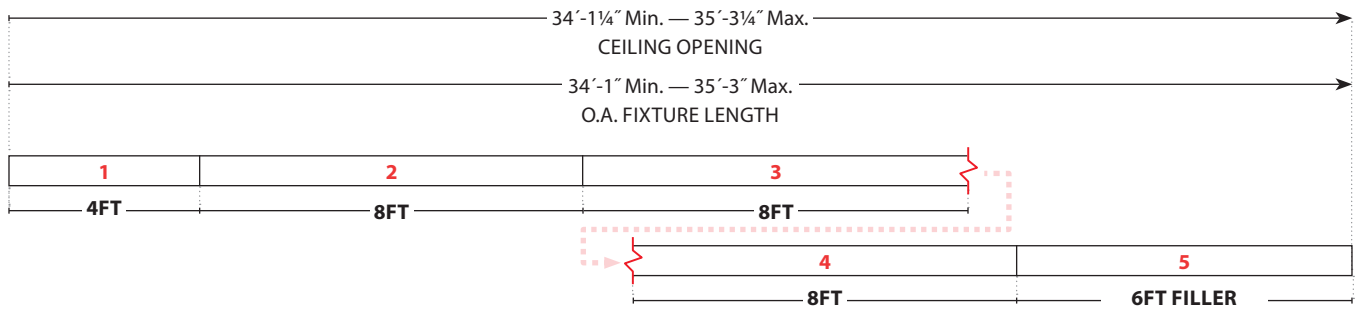

36FT

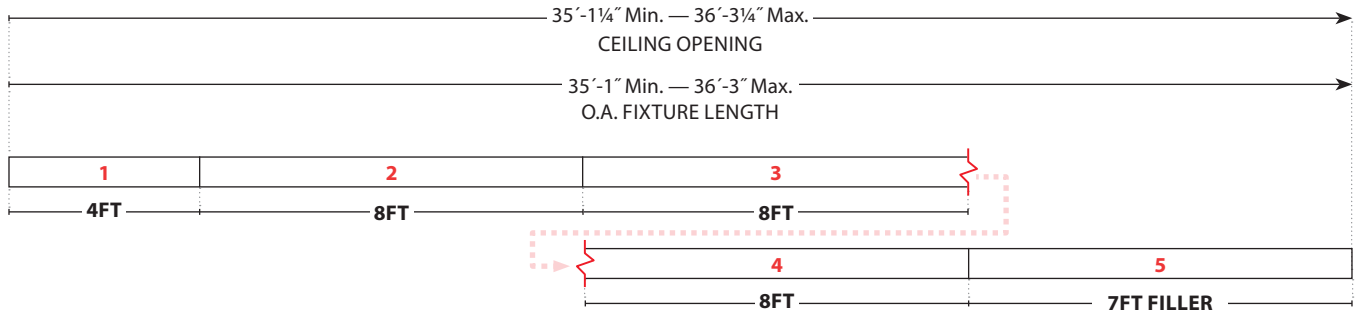

37FT

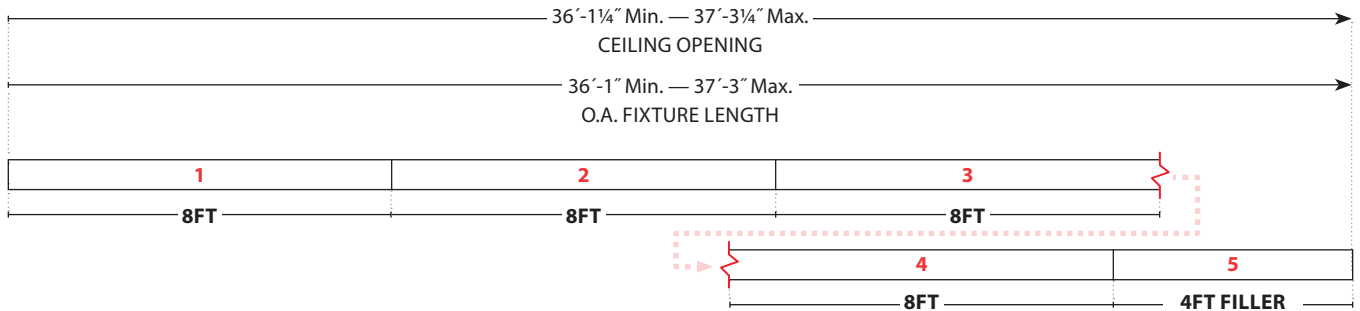

WARNING: Ground fixture in accordance with local and national electrical codes. Failure to do so may result in serious personal injury. Fixture Installations should ONLY be done by a qualified licensed electrical professional.

BionicPro5 | Recessed Linear Light Pocket — X3 (Hard Ceiling)

ROW INSTRUCTIONS

BPR05-REC-FLSH-LP-X3-SC (NON-NOMINAL LENGTHS)

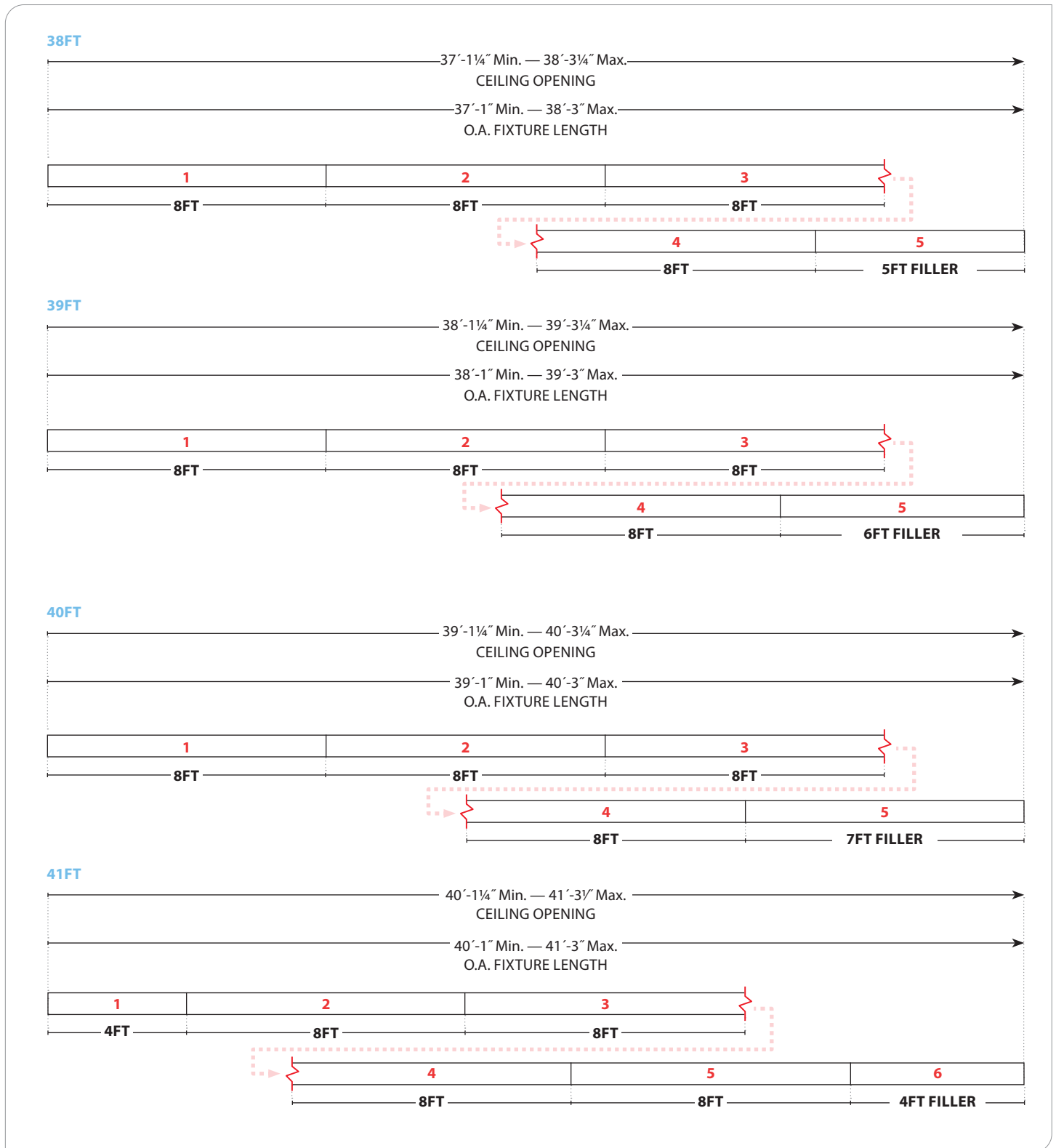

WARNING: Ground fixture in accordance with local and national electrical codes. Failure to do so may result in serious personal injury. Fixture installations should ONLY be done by a qualified licensed electrical professional.

BionicPro5 | Recessed Linear Light Pocket — X3 (Hard Ceiling)

ROW INSTRUCTIONS

BPRO5-REC-FLSH-LP-X3-SC (NON-NOMINAL LENGTHS)

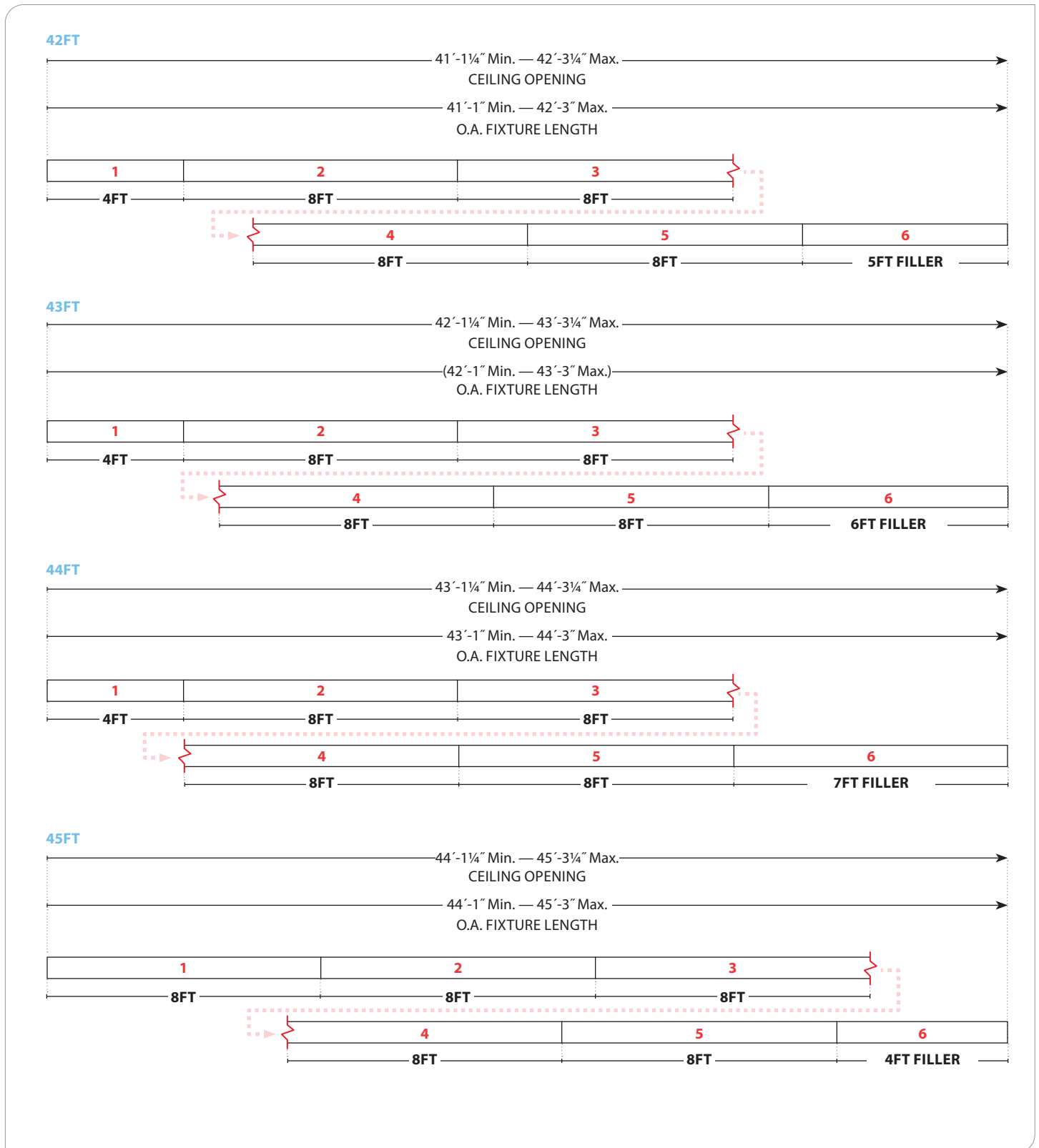

WARNING: Ground fixture in accordance with local and national electrical codes. Failure to do so may result in serious personal injury. Fixture installations should ONLY be done by a qualified licensed electrical professional.

BionicPro5 | Recessed Linear Light Pocket — X3 (Hard Ceiling)

ROW INSTRUCTIONS

BPRO5-REC-FLSH-LP-X3-SC
(NON-NOMINAL LENGTHS)

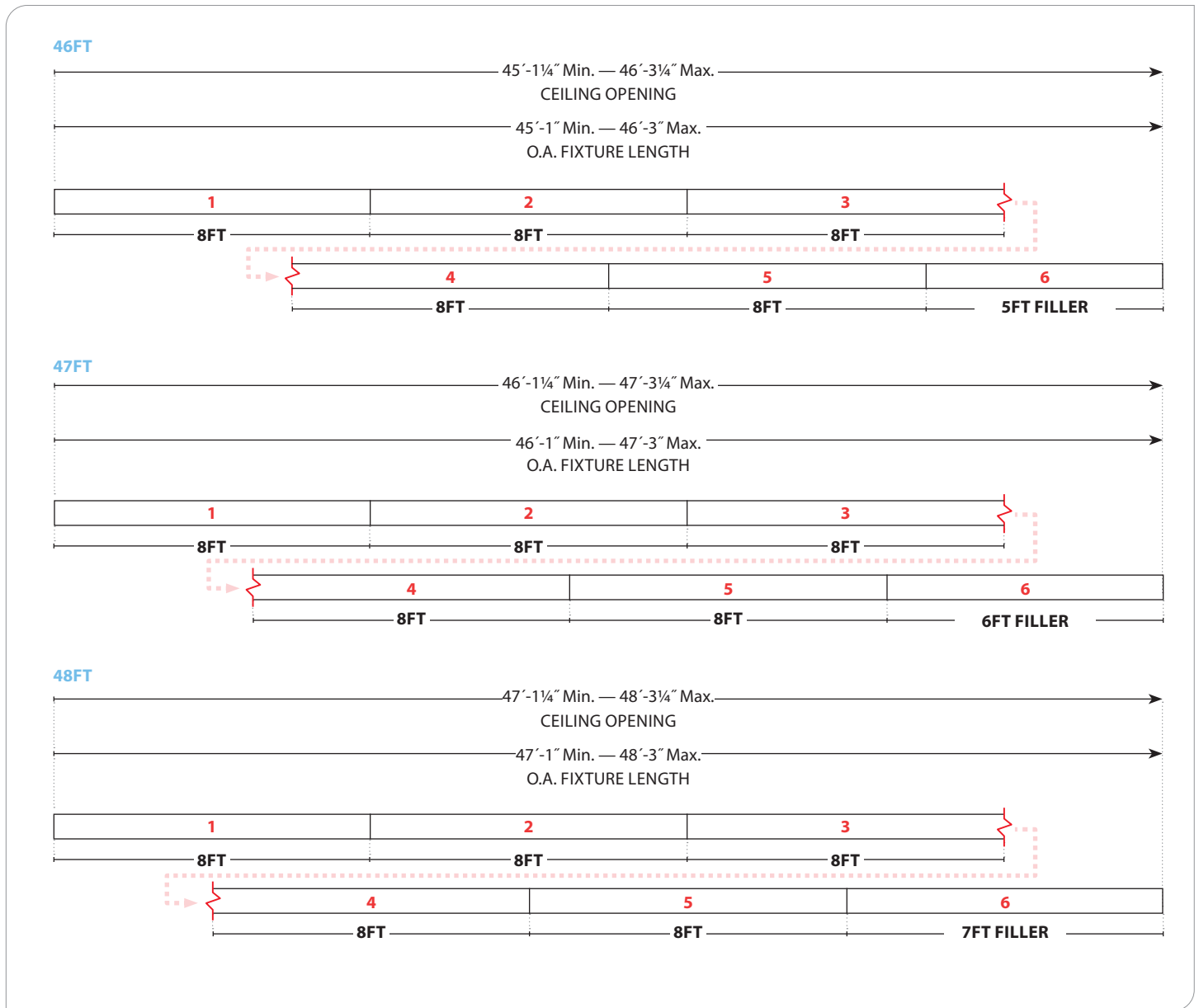

WARNING: Ground fixture in accordance with local and national electrical codes. Failure to do so may result in serious personal injury. Fixture installations should ONLY be done by a qualified licensed electrical professional.

BionicPro5 | Recessed Linear Light Pocket — X3 (Hard Ceiling)

ROW INSTRUCTIONS

BPR05-REC-FLSH-LP-X3-SC
(NON-NOMINAL LENGTHS)

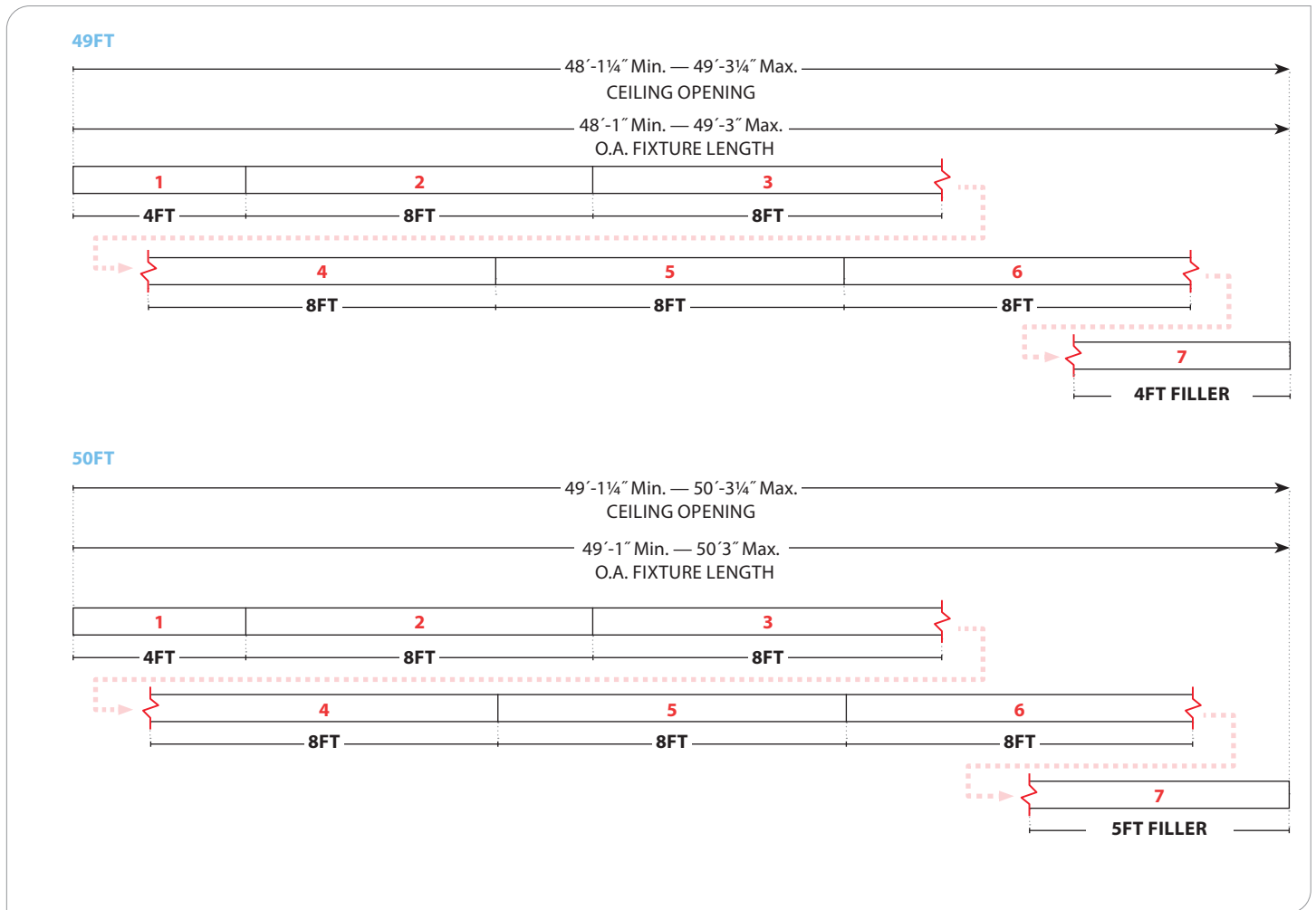

WARNING: Ground fixture in accordance with local and national electrical codes. Failure to do so may result in serious personal injury. Fixture Installations should ONLY be done by a qualified licensed electrical professional.