

# BionicPro4 | Perimeter Light Pocket — X3 (Hard Ceiling)



PRUDENTIAL LTG.

PRULITE.COM 213.746.0360

## ROW INSTRUCTIONS

### BPRO4-PER-FLSH-LP-X3-SC (NON-NOMINAL LENGTHS)

#### GENERAL SPECIFICATIONS

- **DRIVER:** UL recognized electronic drivers.  
DM01 = 0-10v 1% Dimming.  
ND = NON-DIMMING.  
**FIXTURE INPUT WATTS PER 4' SECTION =**  
LO = 15w, MO = 22w, SO = 31w, HO = 42w.
- **SC =** Single Circuit.
- **EMHE =** Emergency Battery Pack (CA Title 20 compliant)
- **IC RATING:** Fixtures are IC Rated unless Insulation Detector is factory-installed. (Insulation Detector requires 120 or 277 voltage).
- **LABELS:** ETL LED luminaires (conforms to UL 1598).
- **FINISH (POWDER COAT):**  
TMW = Textured Matte White. YGW = Gloss White.  
YSL = Silver (Metallic). YBK = Black (Matte).
- **LED BOARDS:** LED27 = 2700K, LED3 = 3000K, LED35 = 3500K, LED4 = 4000K, LED5 = 5000K (-90 = 90CRI).
- **REFLECTORS:** Die-formed #24 GA. White Optics M16.
- **LENS:** Composite polymer.  
SAL = Satin Acrylic, MGZ = Medium Wall Graze,  
PFL = Perimeter Fill.
- **HOUSING:** Die-formed #20 GA. cold rolled steel.
- **CIRCUIT ASSEMBLY:** Prudential Ltg. reserves the right to change Circuit Assemblies from #16 gauge to #12 gauge, as needed.

#### NOTES

- Seamless composite lens is shipped rolled in bulk for rows over 8', contractor to cut to size and install. For row 8' and under, lens is cut and installed in house.
- All dimensions shown include (2) 1/2" thick finish plates.
- Individual fixtures not intended for continuous row mounting.
- Symbol  indicates emergency fixture location.
- Submittal drawings are used for review purposes only. (Go to prulite.com for installation instructions).

#### END PLATE DIMENSIONS —

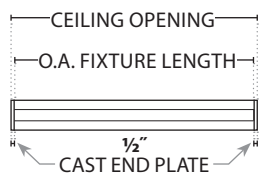

#### EMHE ACCESSORY PLATE —

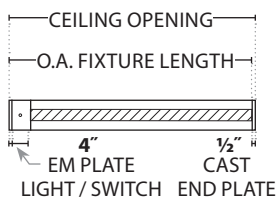

#### CROSS SECTIONS

SEE SPEC SHEET FOR ADDITIONAL GRID CEILINGS

X1 —

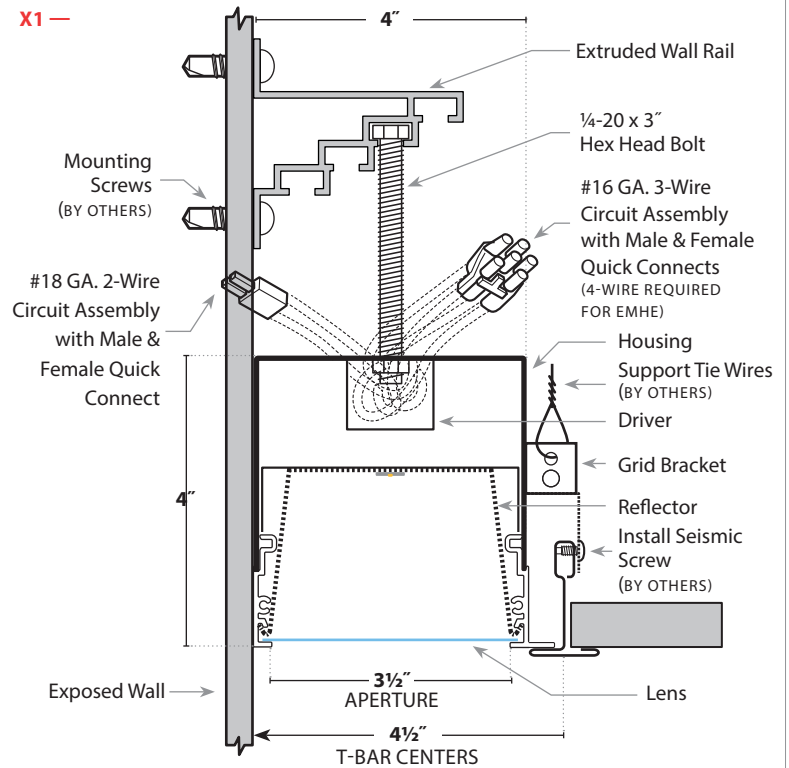

#### INSULATION DETECTOR / EMHE —

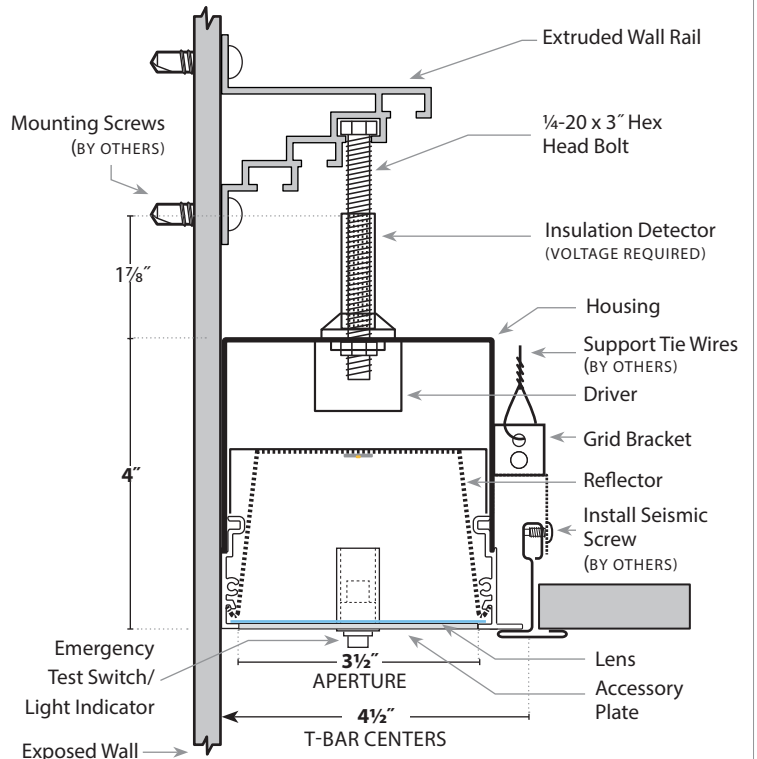

# BionicPro4 | Perimeter Light Pocket — X3 (Hard Ceiling)

## ROW INSTRUCTIONS

**BPRO4-PER-FLSH-LP-X3-SC (NON-NOMINAL LENGTHS)**

### TO REQUEST EMERGENCY FIXTURES:

- Use the fixture number (shown here in red) 17' row with EMHE on Fixtures 1 and 3.
- OR**
- Print out layout and circle where emergency is needed and send in with your order.

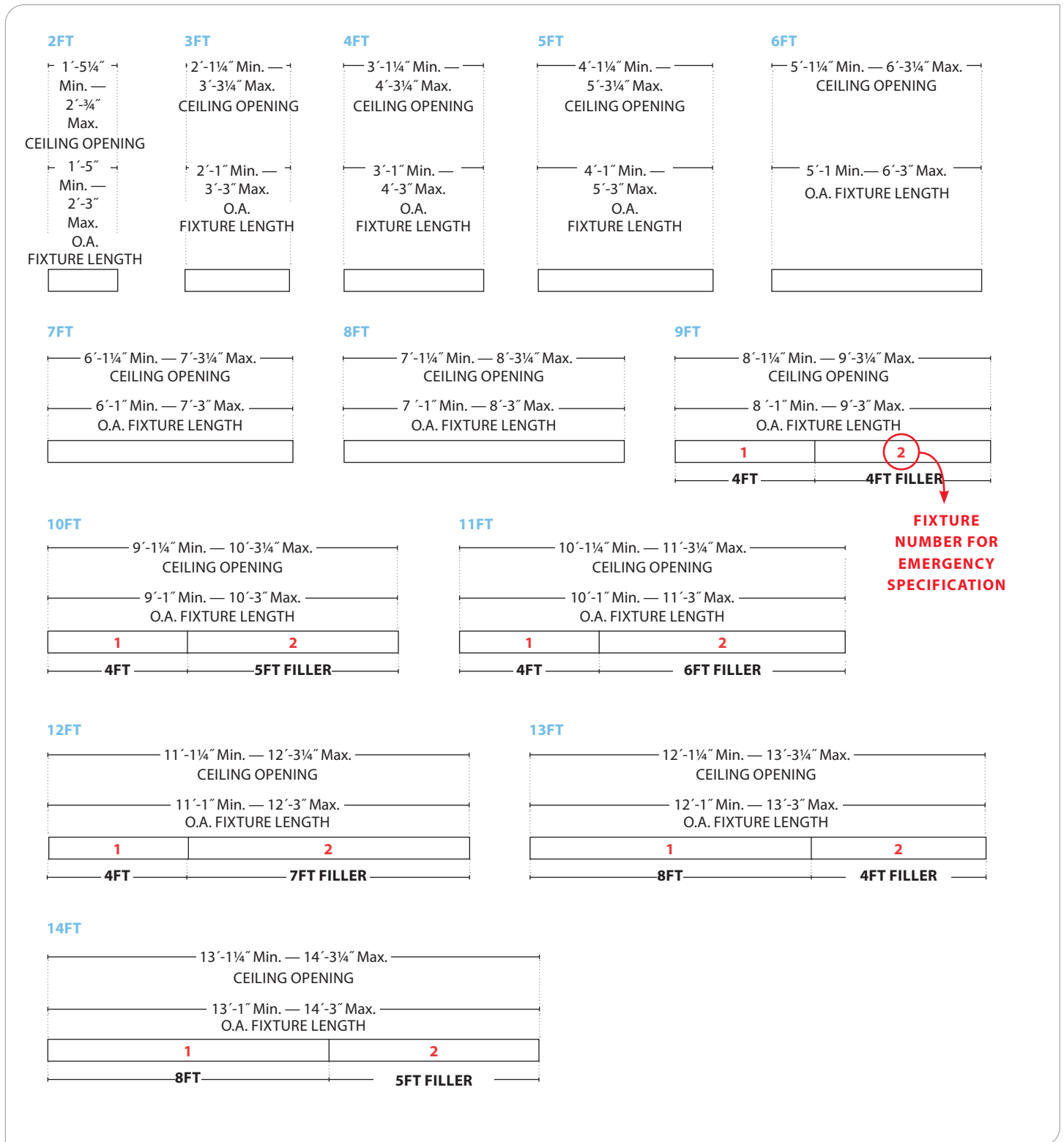

**WARNING:** Ground fixture in accordance with local and national electrical codes. Failure to do so may result in serious personal injury. Fixture installations should ONLY be done by a qualified licensed electrical professional.

# BionicPro4 | Perimeter Light Pocket — X3 (Hard Ceiling)

## ROW INSTRUCTIONS

### BPRO4-PER-FLSH-LP-X3-SC (NON-NOMINAL LENGTHS)

#### 15FT

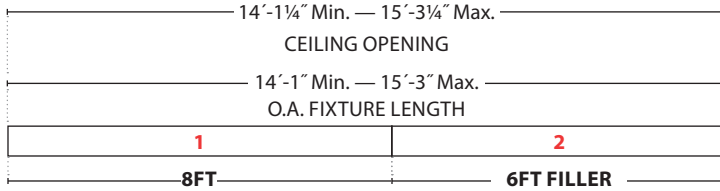

#### 16FT

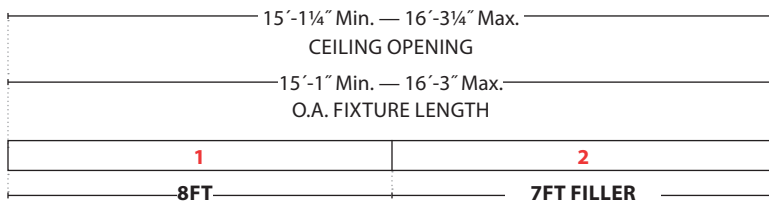

#### 17FT

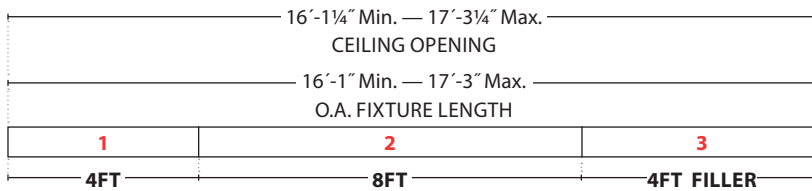

#### 18FT

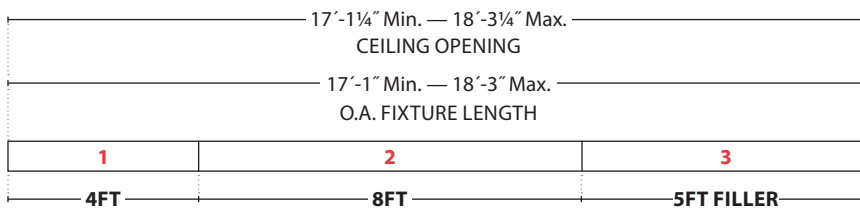

#### 19FT

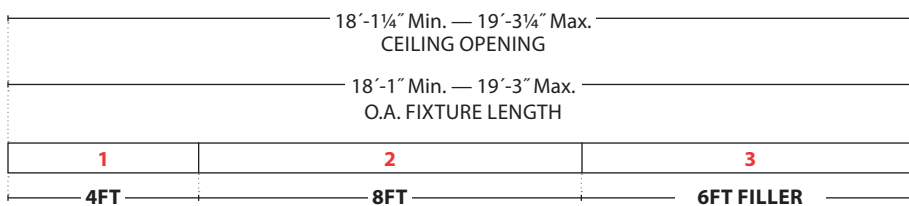

**WARNING:** Ground fixture in accordance with local and national electrical codes. Failure to do so may result in serious personal injury. Fixture Installations should ONLY be done by a qualified licensed electrical professional.

# BionicPro4 | Perimeter Light Pocket — X3 (Hard Ceiling)

## ROW INSTRUCTIONS

### BPRO4-PER-FLSH-LP-X3-SC (NON-NOMINAL LENGTHS)

20FT

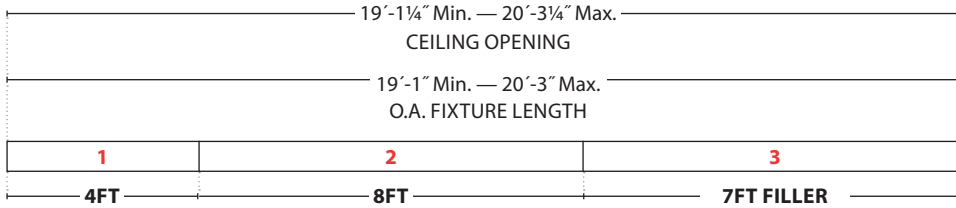

21FT

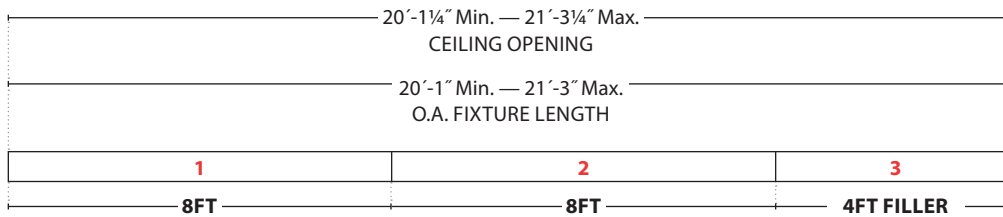

22FT

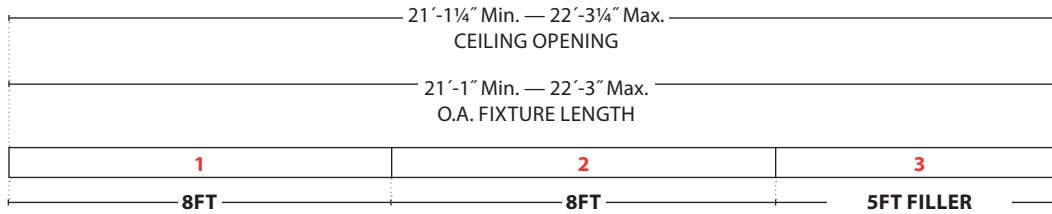

23FT

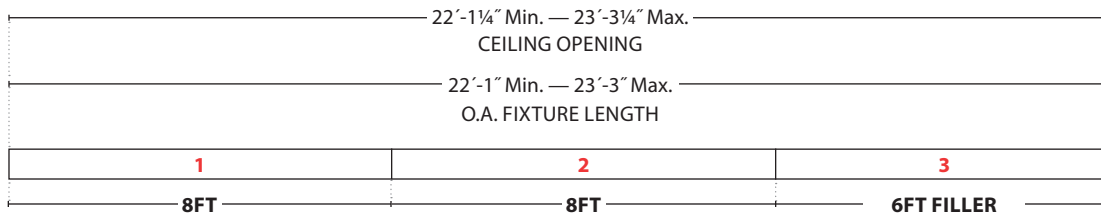

24FT

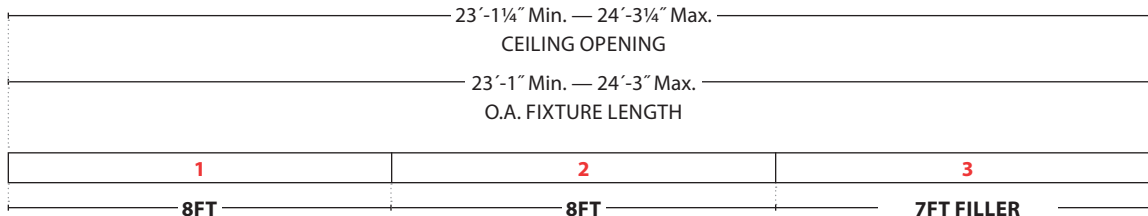

**WARNING:** Ground fixture in accordance with local and national electrical codes. Failure to do so may result in serious personal injury.  
Fixture Installations should ONLY be done by a qualified licensed electrical professional.

# BionicPro4 | Perimeter Light Pocket — X3 (Hard Ceiling)

## ROW INSTRUCTIONS

### BPRO4-PER-FLSH-LP-X3-SC (NON-NOMINAL LENGTHS)

#### 25FT

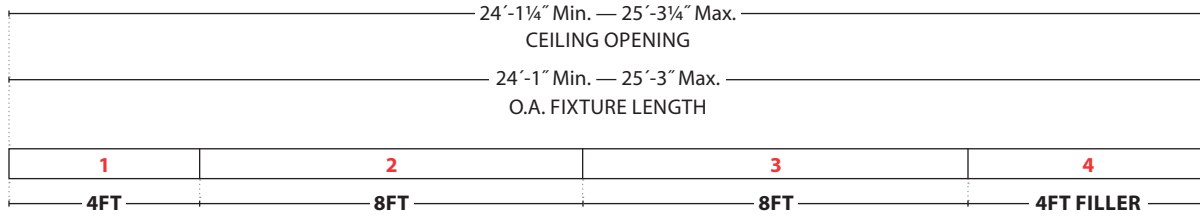

#### 26FT

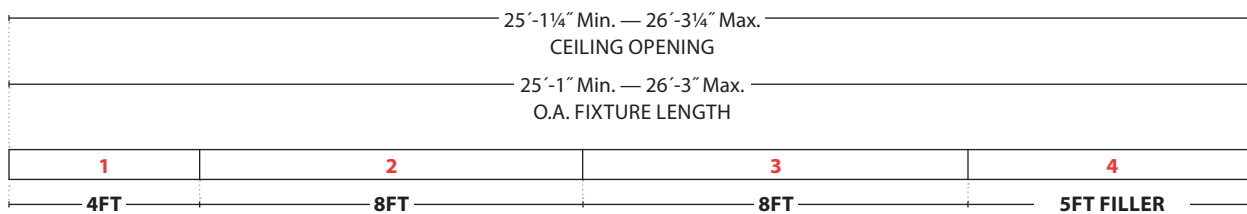

#### 27FT

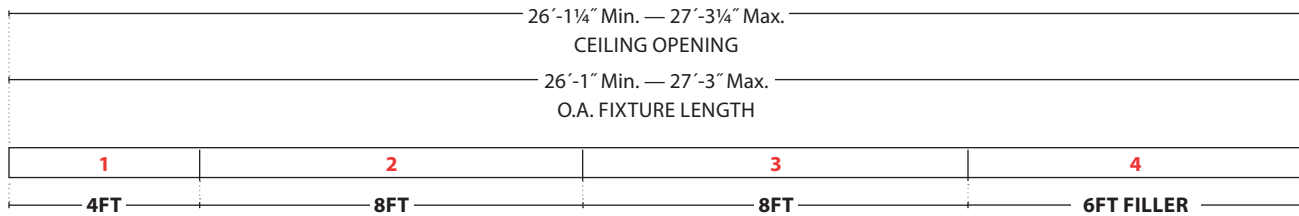

#### 28FT

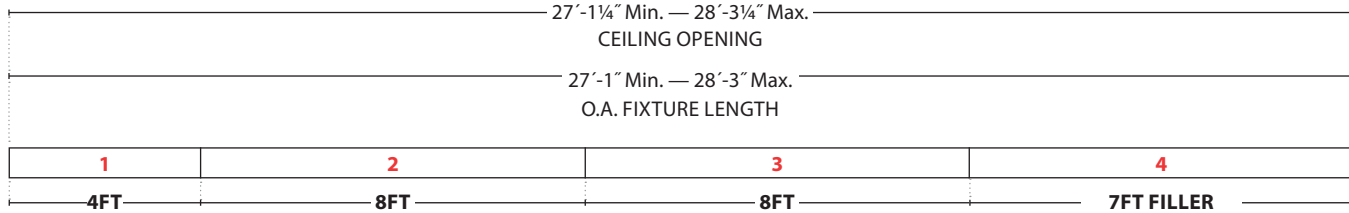

#### 29FT

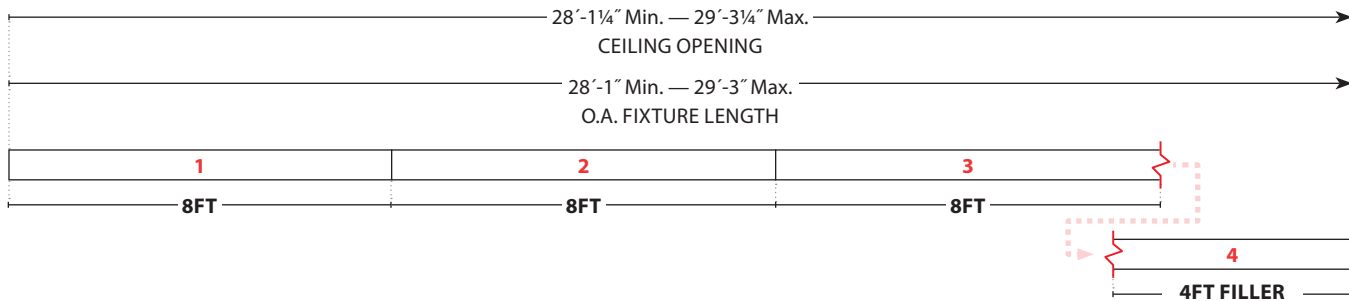

**WARNING:** Ground fixture in accordance with local and national electrical codes. Failure to do so may result in serious personal injury. Fixture Installations should ONLY be done by a qualified licensed electrical professional.

# BionicPro4 | Perimeter Light Pocket — X3 (Hard Ceiling)

## ROW INSTRUCTIONS

### BPRO4-PER-FLSH-LP-X3-SC (NON-NOMINAL LENGTHS)

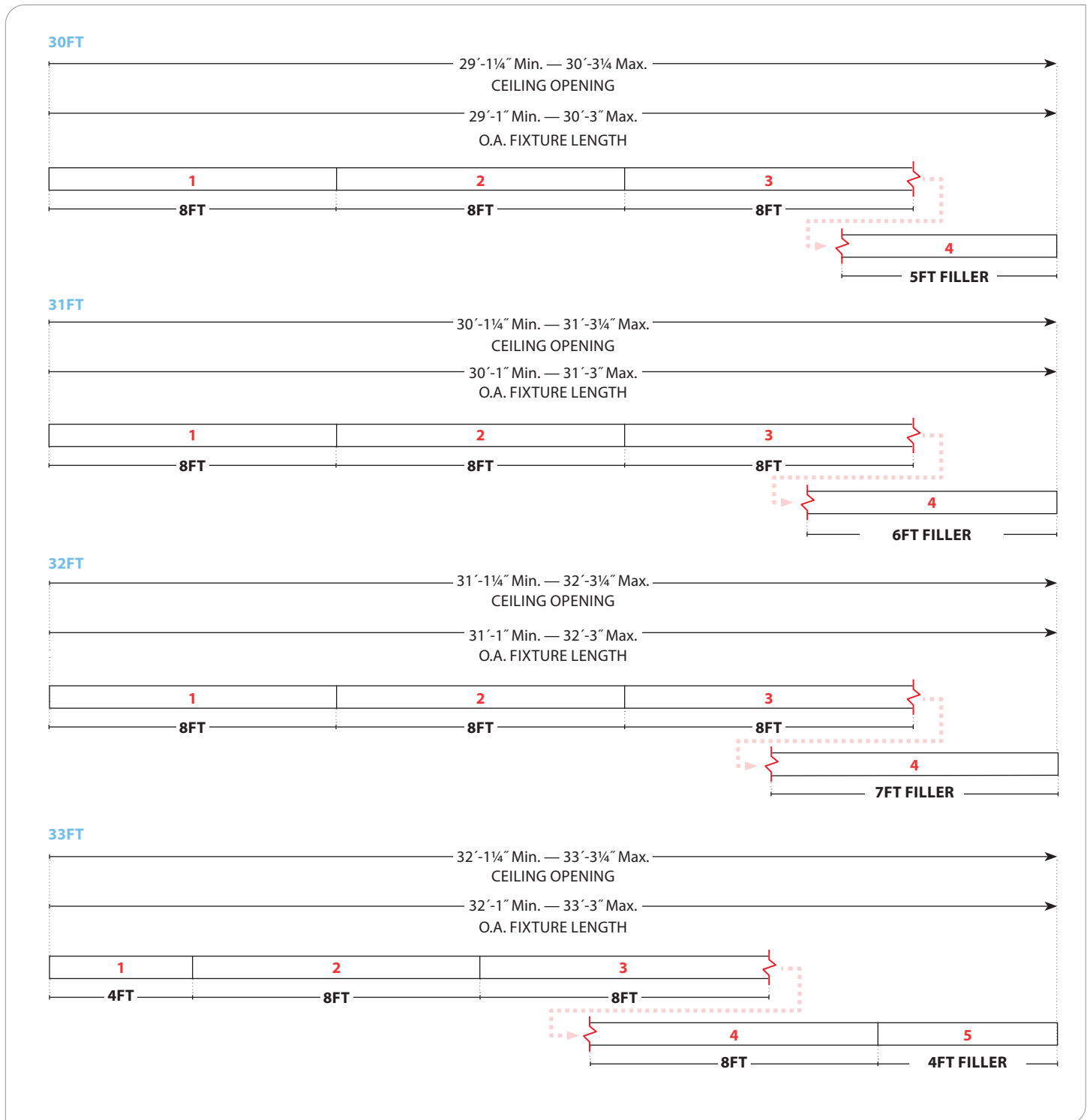

**WARNING:** Ground fixture in accordance with local and national electrical codes. Failure to do so may result in serious personal injury. Fixture installations should ONLY be done by a qualified licensed electrical professional.

# BionicPro4 | Perimeter Light Pocket — X3 (Hard Ceiling)

## ROW INSTRUCTIONS

### BPRO4-PER-FLSH-LP-X3-SC (NON-NOMINAL LENGTHS)

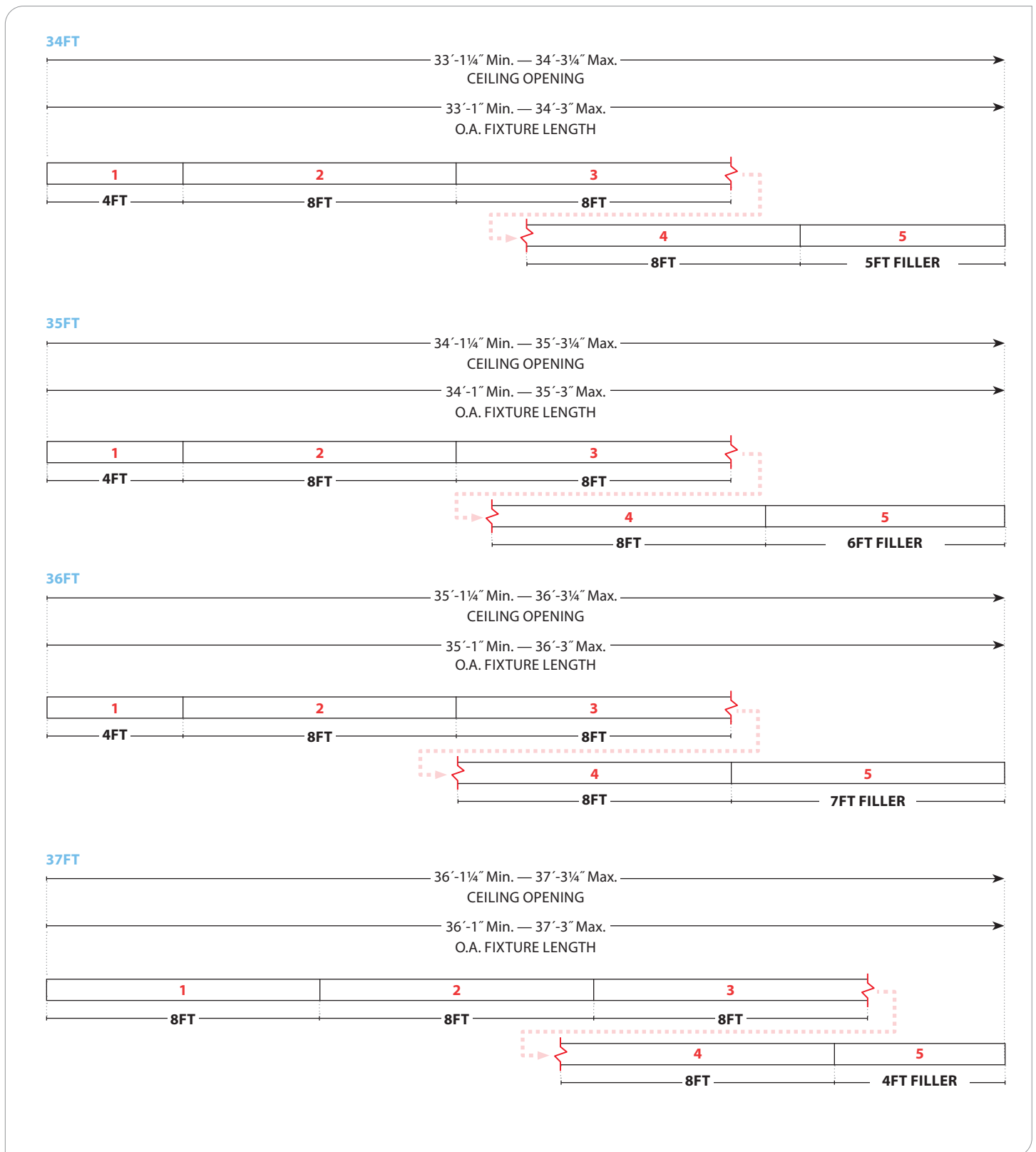

**WARNING:** Ground fixture in accordance with local and national electrical codes. Failure to do so may result in serious personal injury. Fixture installations should ONLY be done by a qualified licensed electrical professional.

# BionicPro4 | Perimeter Light Pocket — X3 (Hard Ceiling)

## ROW INSTRUCTIONS

### BPRO4-PER-FLSH-LP-X3-SC (NON-NOMINAL LENGTHS)

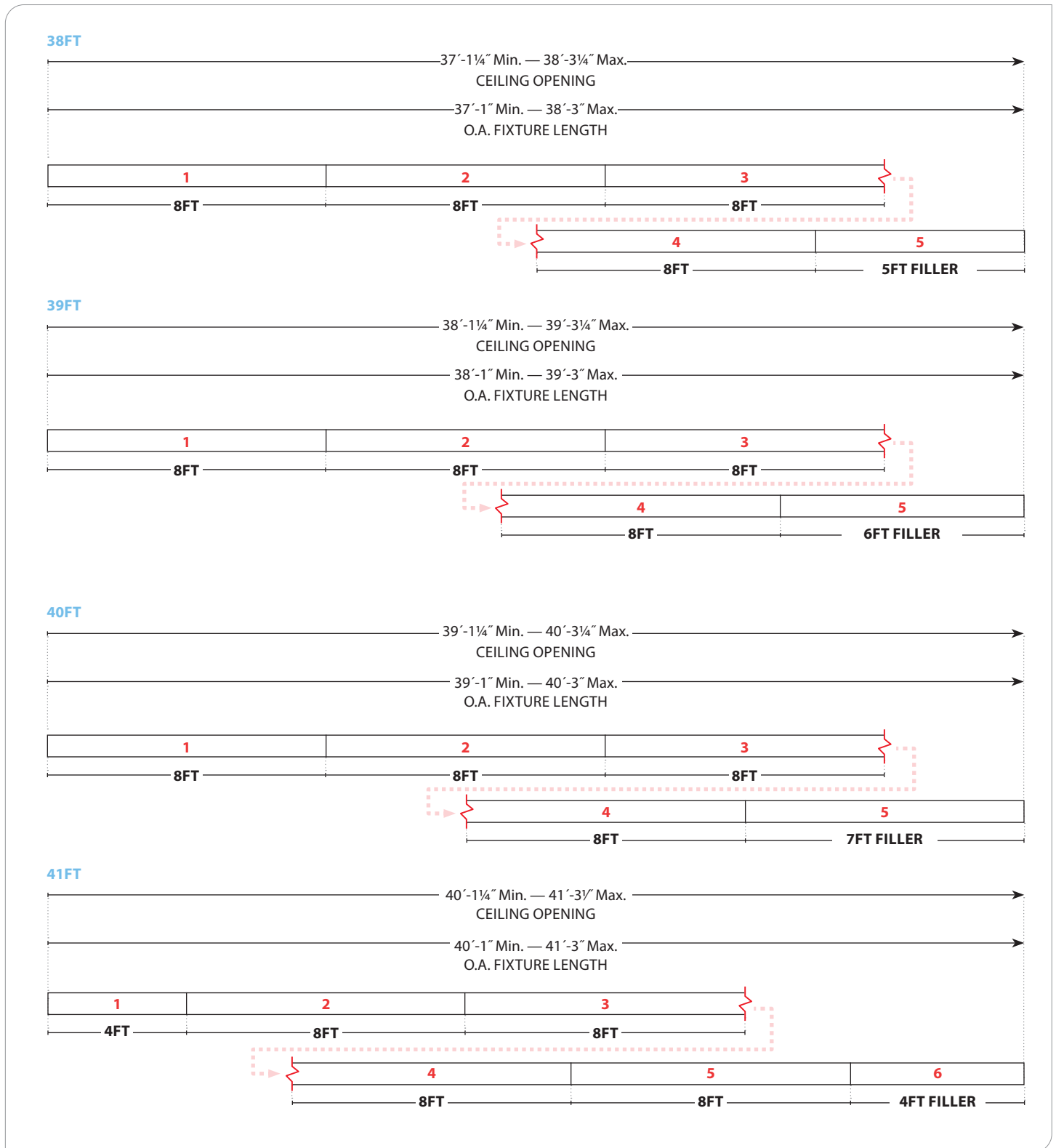

**WARNING:** Ground fixture in accordance with local and national electrical codes. Failure to do so may result in serious personal injury. Fixture installations should ONLY be done by a qualified licensed electrical professional.

# BionicPro4 | Perimeter Light Pocket — X3 (Hard Ceiling)

## ROW INSTRUCTIONS

### BPRO4-PER-FLSH-LP-X3-SC (NON-NOMINAL LENGTHS)

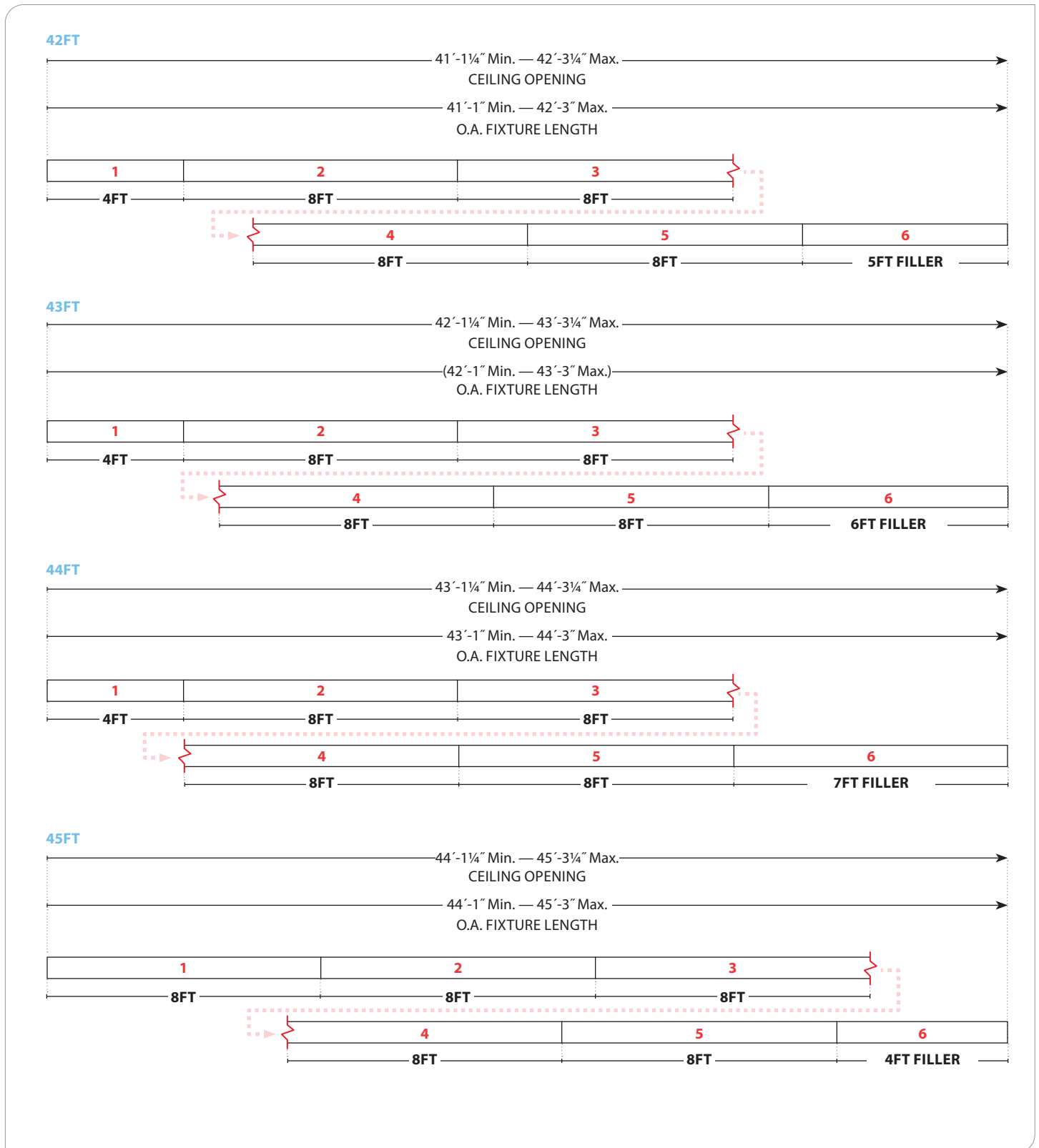

**WARNING:** Ground fixture in accordance with local and national electrical codes. Failure to do so may result in serious personal injury. Fixture Installations should ONLY be done by a qualified licensed electrical professional.

# BionicPro4 | Perimeter Light Pocket — X3 (Hard Ceiling)

## ROW INSTRUCTIONS

### BPRO4-PER-FLSH-LP-X3-SC (NON-NOMINAL LENGTHS)

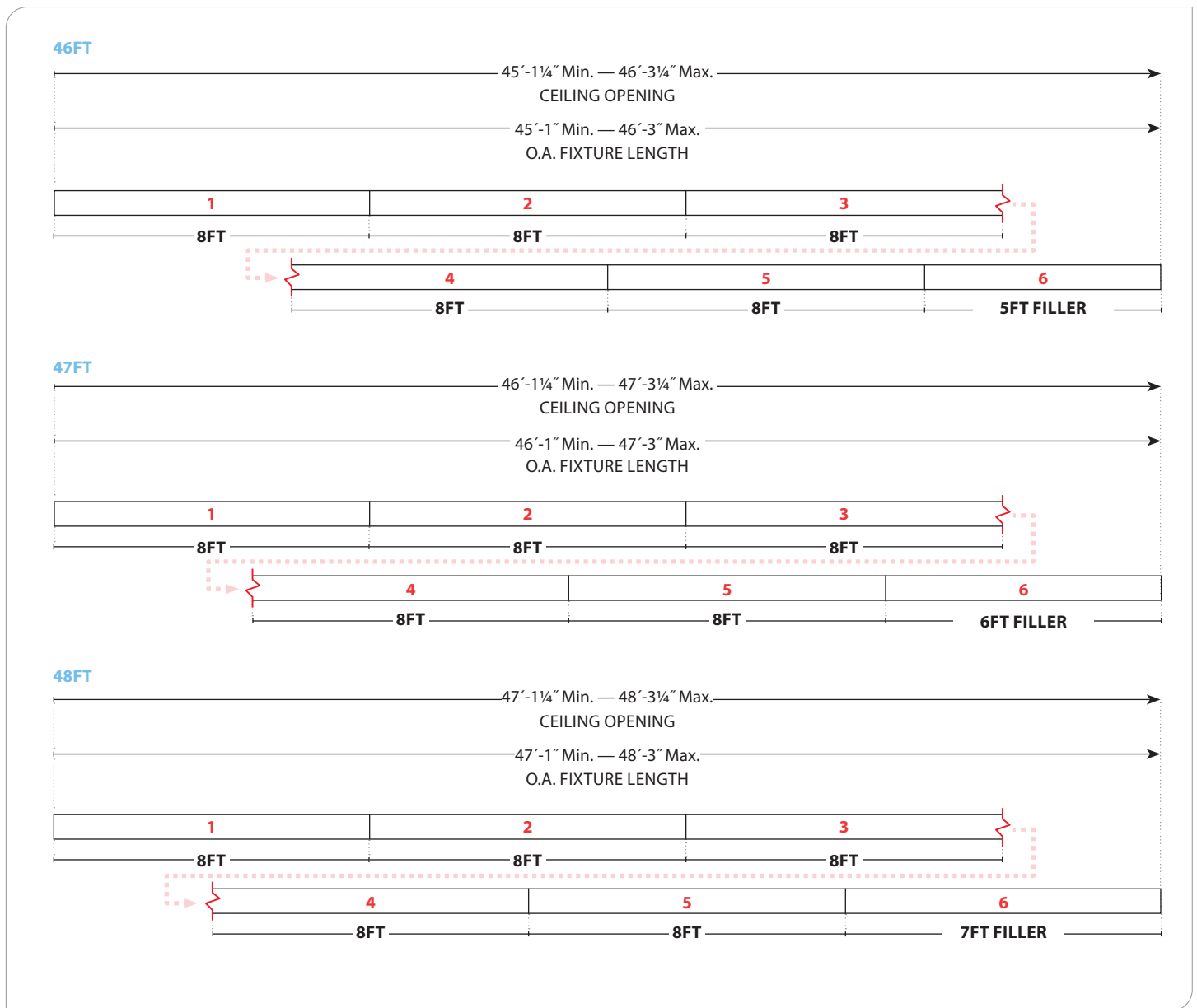

**WARNING:** Ground fixture in accordance with local and national electrical codes. Failure to do so may result in serious personal injury. Fixture Installations should ONLY be done by a qualified licensed electrical professional.

# BionicPro4 | Perimeter Light Pocket — X3 (Hard Ceiling)

## ROW INSTRUCTIONS

**BPRO4-PER-FLSH-LP-X3-SC  
(NON-NOMINAL LENGTHS)**

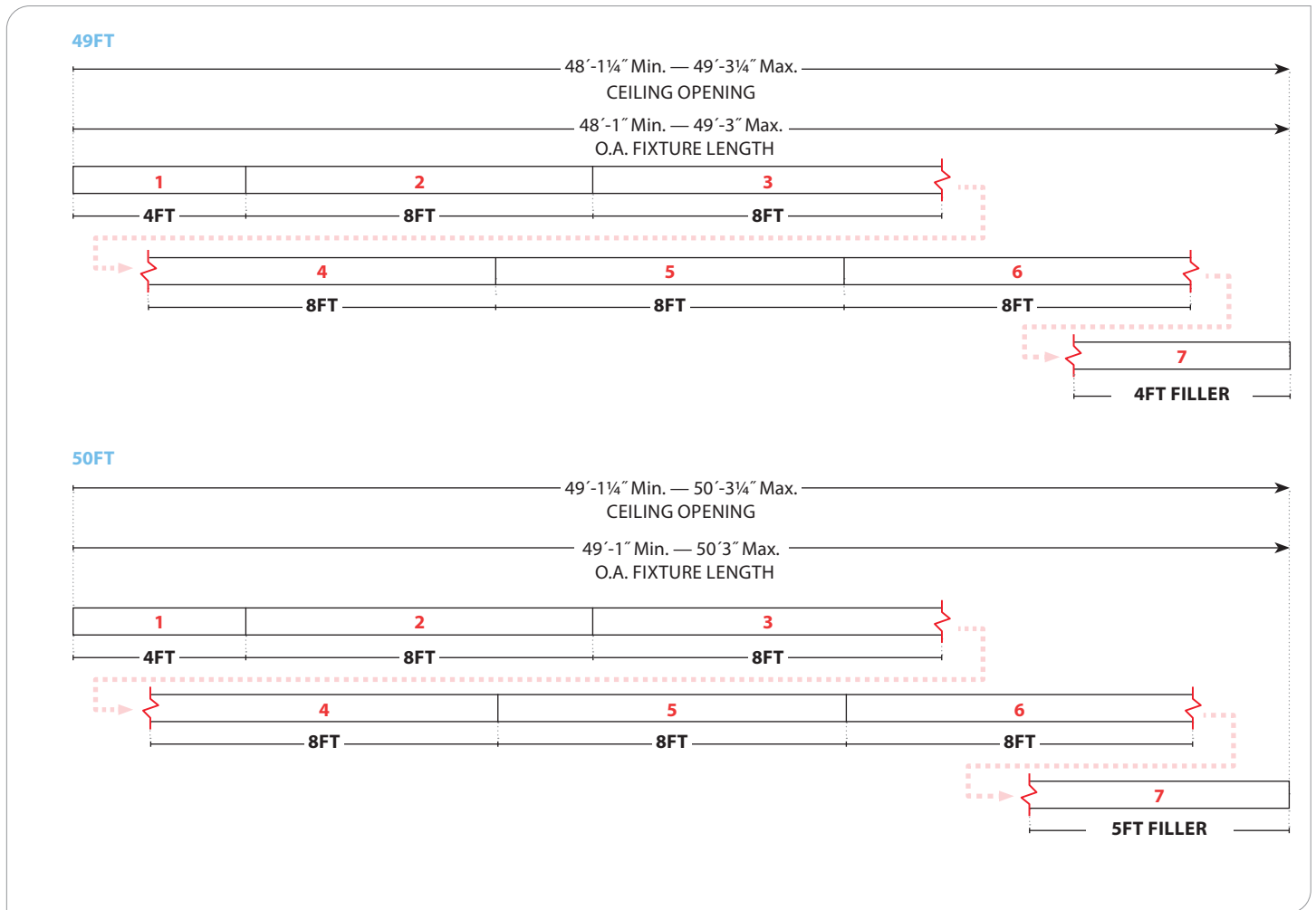

**WARNING:** Ground fixture in accordance with local and national electrical codes. Failure to do so may result in serious personal injury. Fixture Installations should ONLY be done by a qualified licensed electrical professional.