

BionicPro3 | Recessed Linear Light Pocket — X1 (T-Bar)

ROW INSTRUCTIONS

BPRO3-REC-FLSH-LP-X1-SC



PRUDENTIAL LTG.

PRULITE.COM 213.746.0360

GENERAL SPECIFICATIONS

- **DRIVER:** UL recognized electronic drivers. DM01 = 0-10v 1% Dimming. ND = NON-DIMMING.
- **FIXTURE INPUT WATTS PER 4' SECTION =** LO = 15w, MO = 22w, SO = 31w, HO = 42w.
- **SC** = Single Circuit.
- **EMHE** = Emergency Battery Pack (CA Title 20 compliant)
- **IC RATING:** Fixtures are IC Rated unless Insulation Detector is factory-installed. (Insulation Detector requires 120 or 277 voltage).
- **LABELS:** ETL LED luminaires (conforms to UL 1598).
- **FINISH (POWDER COAT):** TMW = Textured Matte White. YGW = Gloss White. YSL = Silver (Metallic). YBK = Black (Matte).
- **LED BOARDS:** LED27 = 2700K, LED3 = 3000K, LED35 = 3500K, LED4 = 4000K, LED5 = 5000K (-90 = 90CRI).
- **REFLECTORS:** Die-formed #24 GA. White Optics M16.
- **LENS:** Composite polymer. SAL = Satin Acrylic, BTW = Batwing.
- **HOUSING:** Die-formed #20 GA. cold rolled steel.
- **CIRCUIT ASSEMBLY:** Prudential Ltg. reserves the right to change Circuit Assemblies from #16 gauge to #12 gauge, as needed.

NOTES

- Seamless composite lens is shipped rolled in bulk for rows over 8', contractor to cut to size and install. For row 8' and under, lens is cut and installed in house.
- All dimensions shown include (2) 1/2" thick finish plates.
- Individual fixtures not intended for continuous row mounting.
- Symbol  indicates emergency fixture location.
- Submittal drawings are used for review purposes only. (Go to prulite.com for installation instructions).

END PLATE DIMENSIONS —

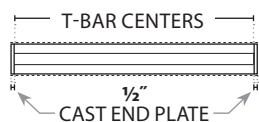

EMHE ACCESSORY PLATE —

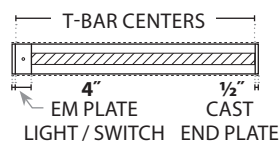

CROSS SECTIONS

SEE SPEC SHEET FOR ADDITIONAL GRID CEILINGS

X1 —

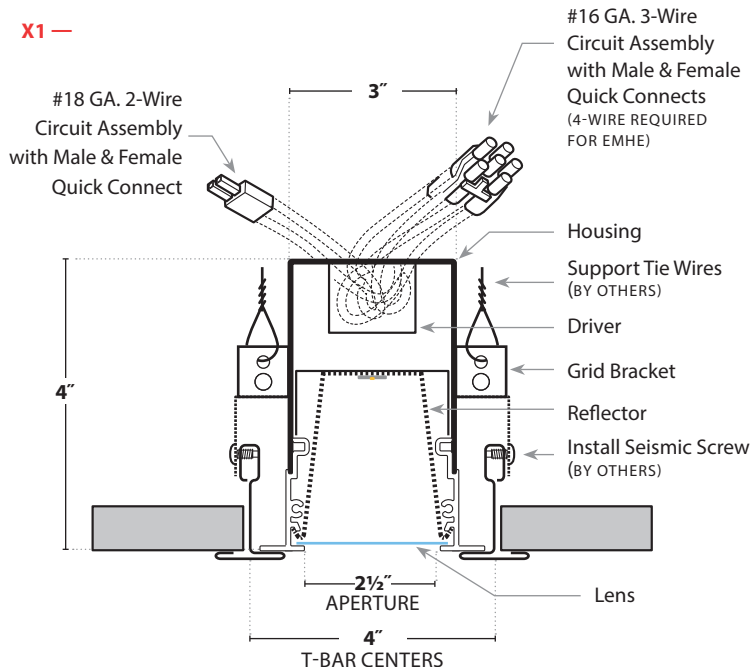

INSULATION DETECTOR / EMHE —

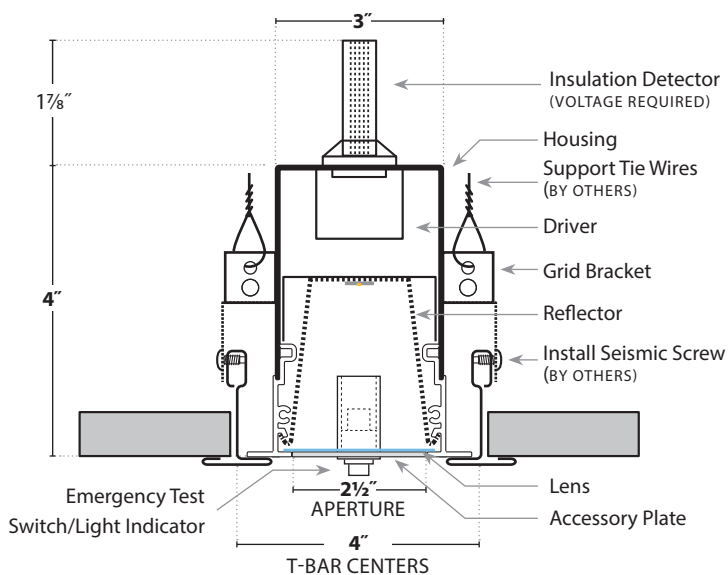

WARNING: Ground fixture in accordance with local and national electrical codes. Failure to do so may result in serious personal injury. Fixture Installations should ONLY be done by a qualified licensed electrical professional.



Prudential Ltg. reserves the right to change design specifications or materials without notice. Please visit prulite.com for most current data. © 2025 All rights reserved - All products manufactured at: Prudential Ltg. 1774 E. 21st Street, Los Angeles, CA 90058

BionicPro3 | Recessed Linear Light Pocket — X1 (T-Bar)

ROW INSTRUCTIONS

BPR03-REC-FLSH-LP-X1-SC

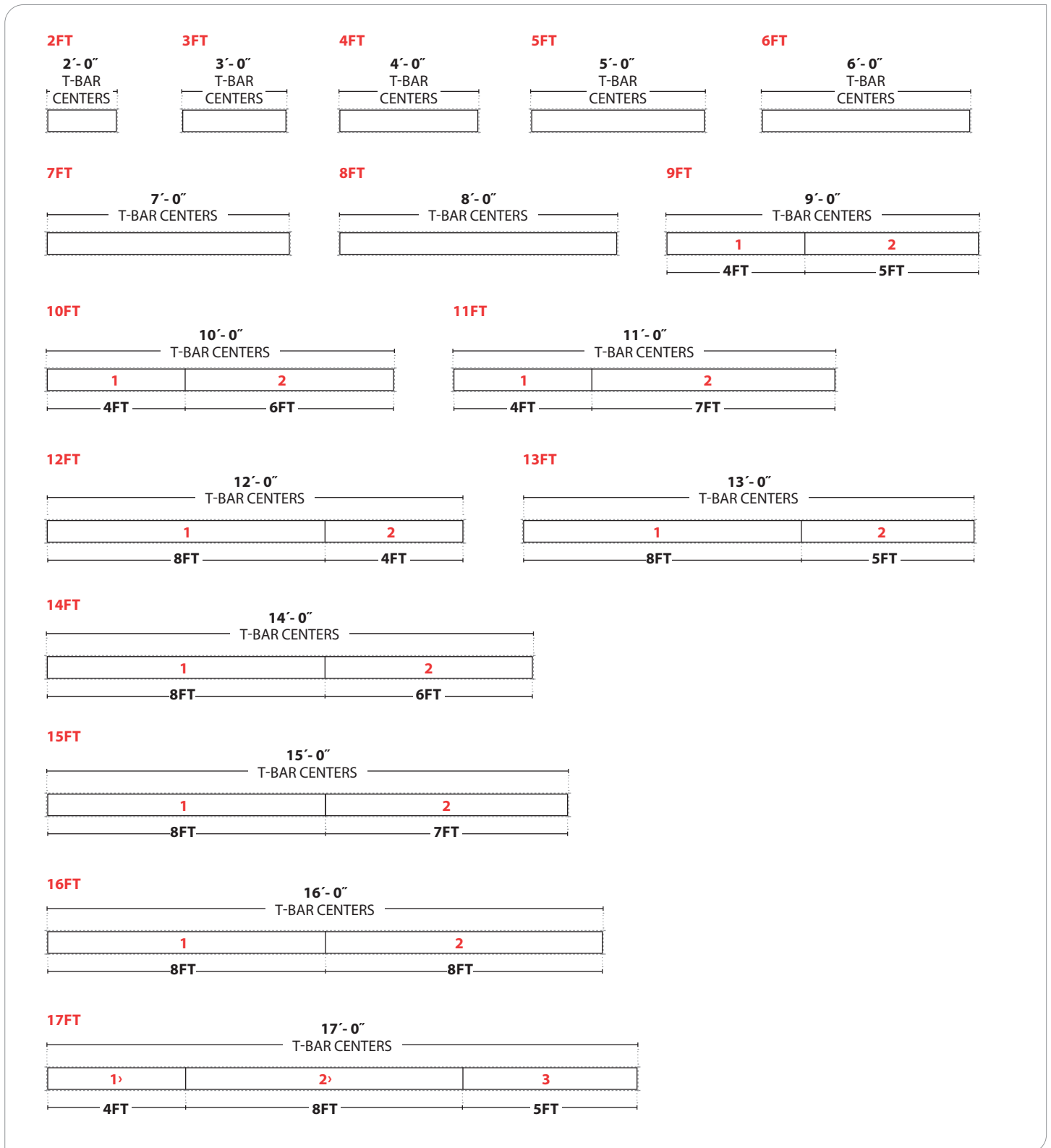

WARNING: Ground fixture in accordance with local and national electrical codes. Failure to do so may result in serious personal injury. Fixture Installations should ONLY be done by a qualified licensed electrical professional.

BionicPro3 | Recessed Linear Light Pocket — X1 (T-Bar)

ROW INSTRUCTIONS

BPR03-REC-FLSH-LP-X1-SC

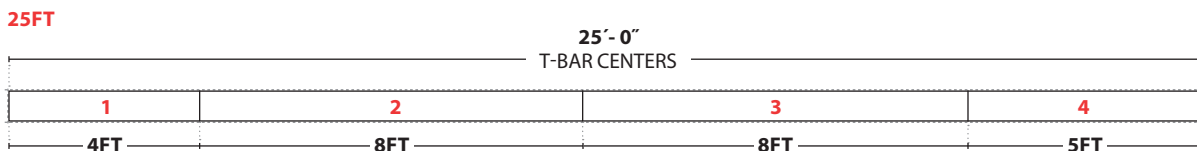
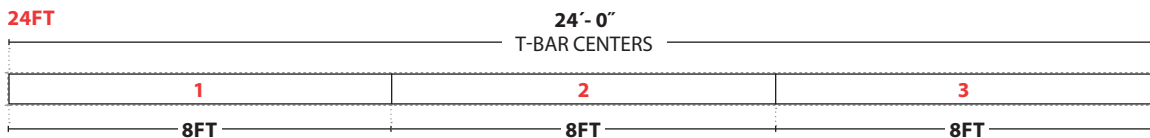
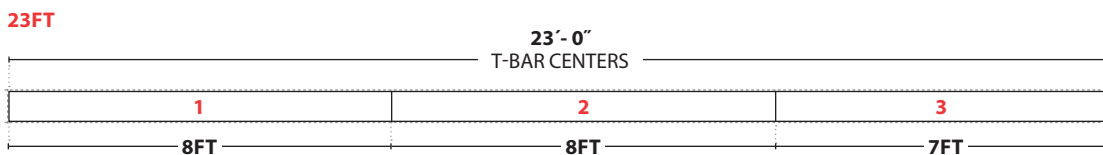
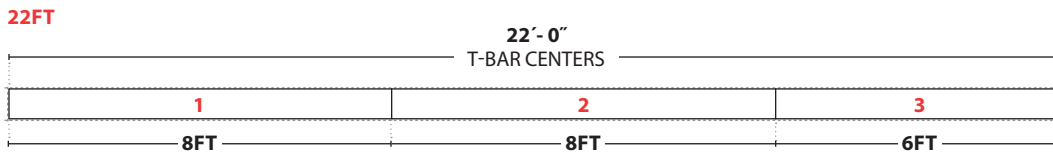
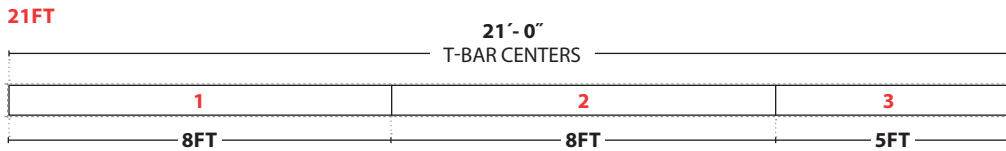
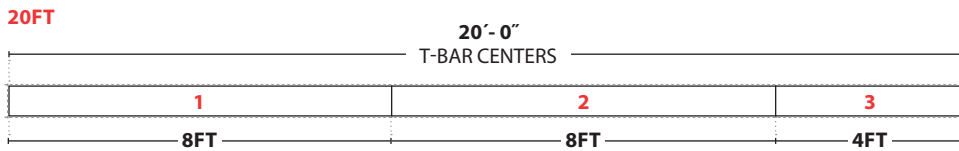
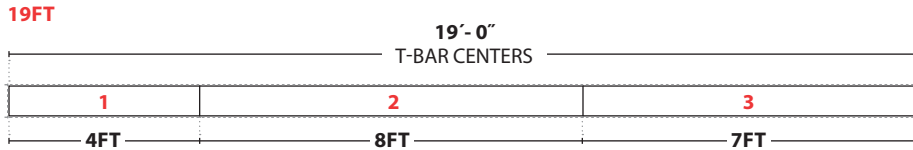
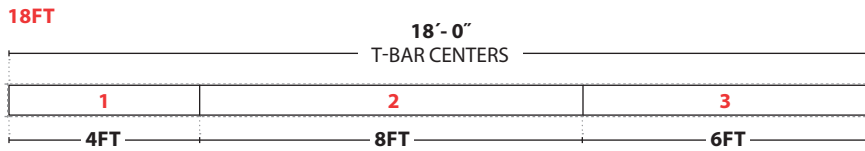

WARNING: Ground fixture in accordance with local and national electrical codes. Failure to do so may result in serious personal injury. Fixture Installations should ONLY be done by a qualified licensed electrical professional.

BionicPro3 | Recessed Linear Light Pocket — X1 (T-Bar)

ROW INSTRUCTIONS

BPR03-REC-FLSH-LP-X1-SC

26FT

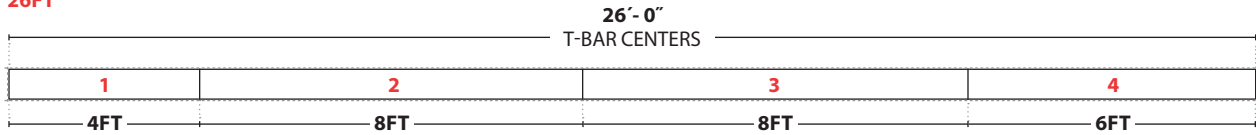

27FT

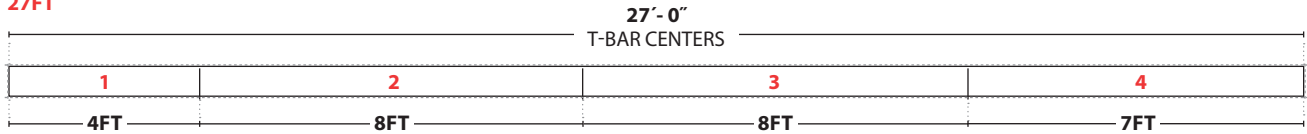

28FT

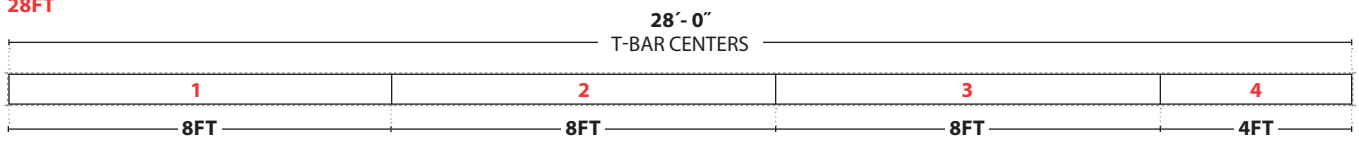

29FT

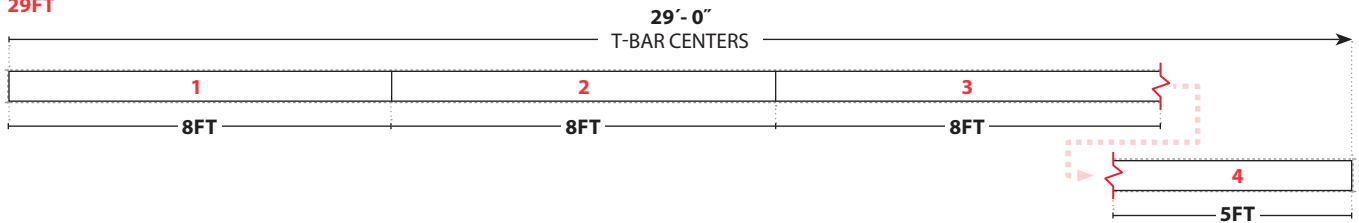

30FT

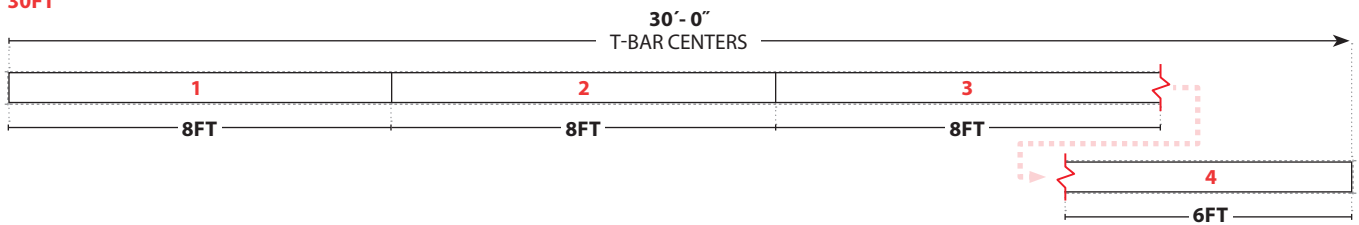

31FT

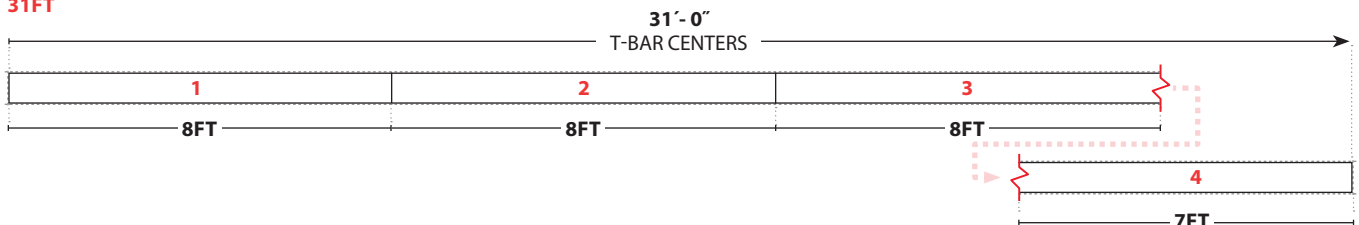

WARNING: Ground fixture in accordance with local and national electrical codes. Failure to do so may result in serious personal injury. Fixture Installations should ONLY be done by a qualified licensed electrical professional.

BionicPro3 | Recessed Linear Light Pocket — X1 (T-Bar)

ROW INSTRUCTIONS

BPR03-REC-FLSH-LP-X1-SC

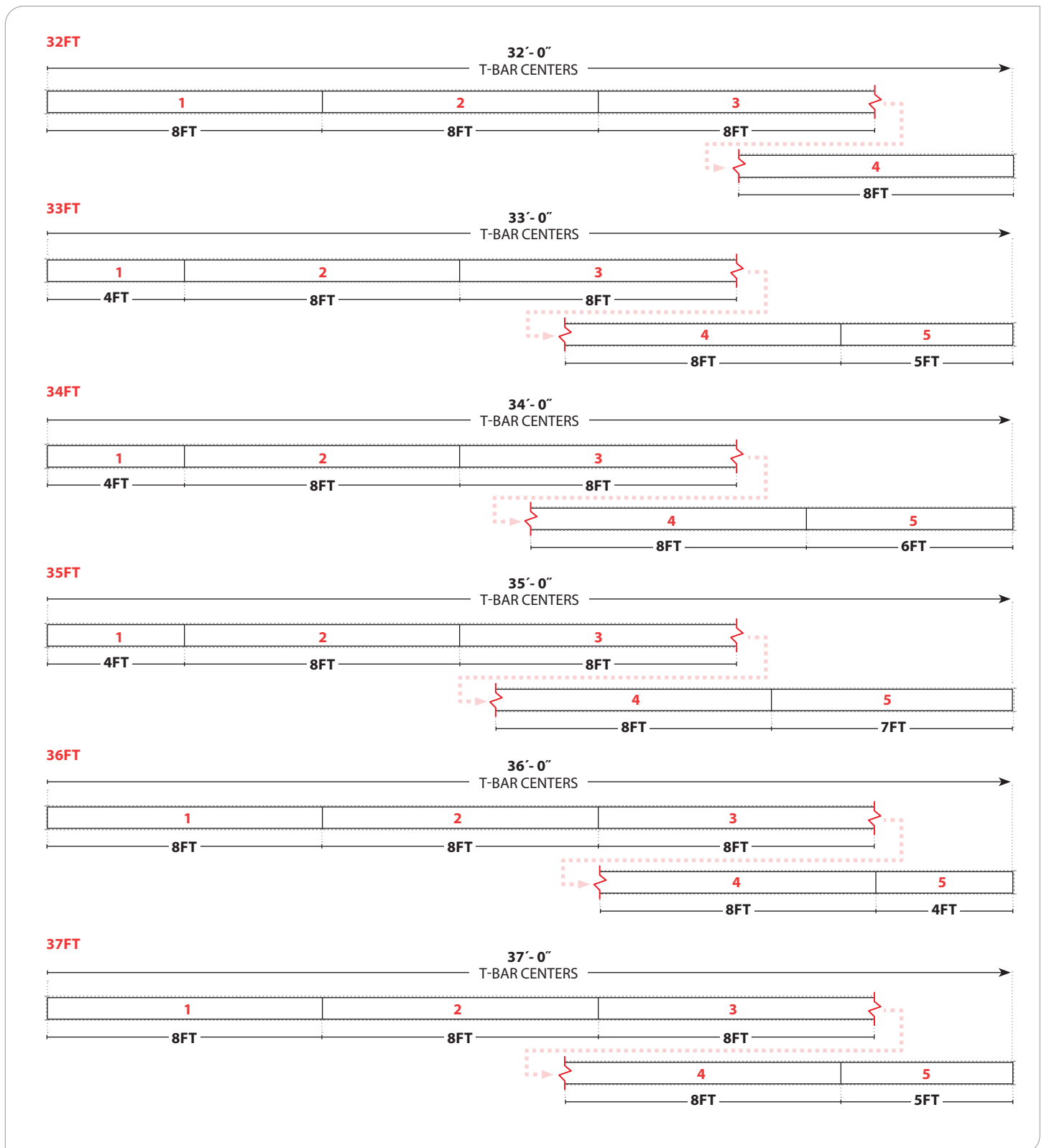

WARNING: Ground fixture in accordance with local and national electrical codes. Failure to do so may result in serious personal injury. Fixture Installations should ONLY be done by a qualified licensed electrical professional.

BionicPro3 | Recessed Linear Light Pocket — X1 (T-Bar)

ROW INSTRUCTIONS

BPR03-REC-FLSH-LP-X1-SC

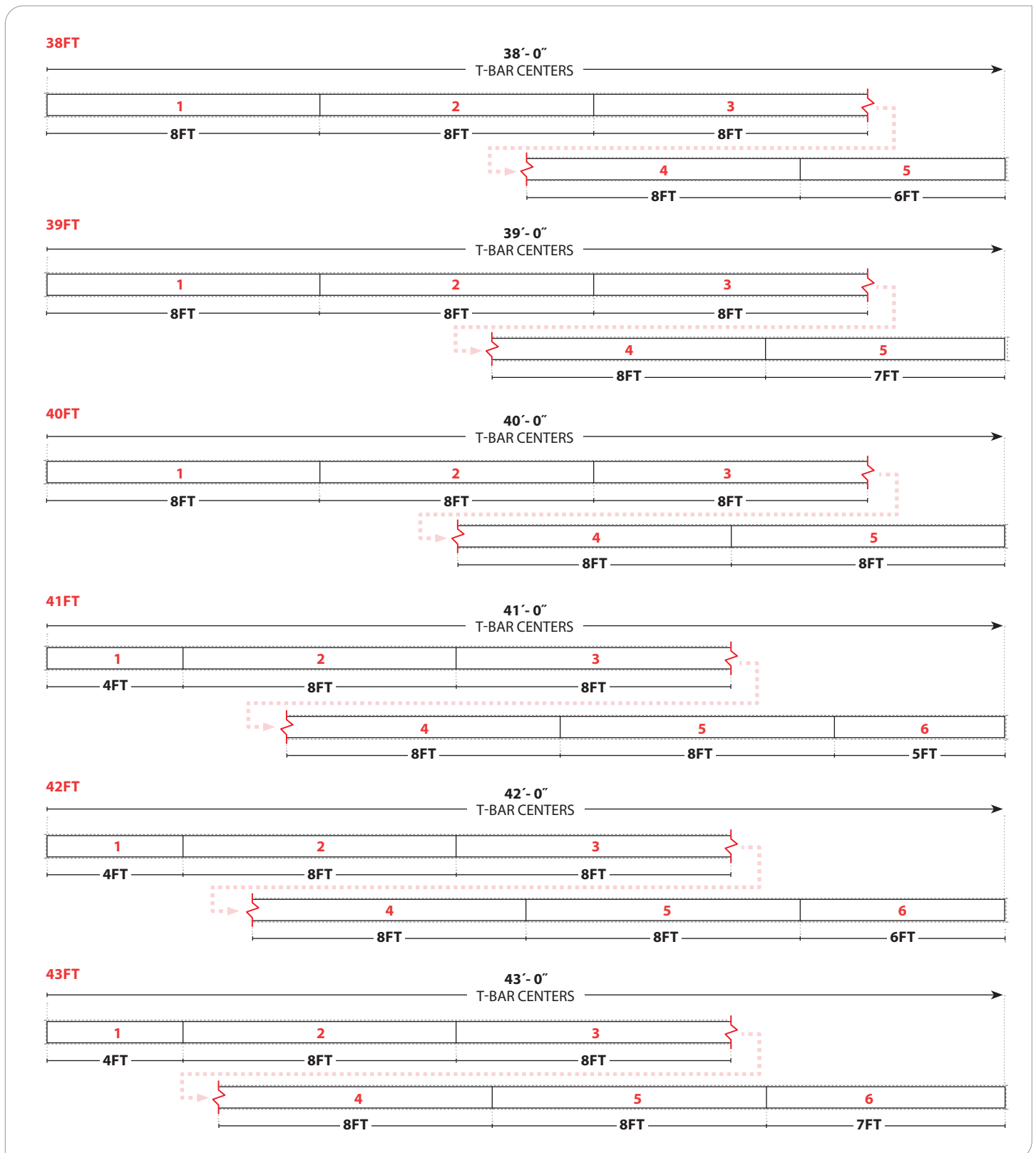

WARNING: Ground fixture in accordance with local and national electrical codes. Failure to do so may result in serious personal injury. Fixture Installations should ONLY be done by a qualified licensed electrical professional.

BionicPro3 | Recessed Linear Light Pocket — X1 (T-Bar)

ROW INSTRUCTIONS

BPRO3-REC-FLSH-LP-X1-SC

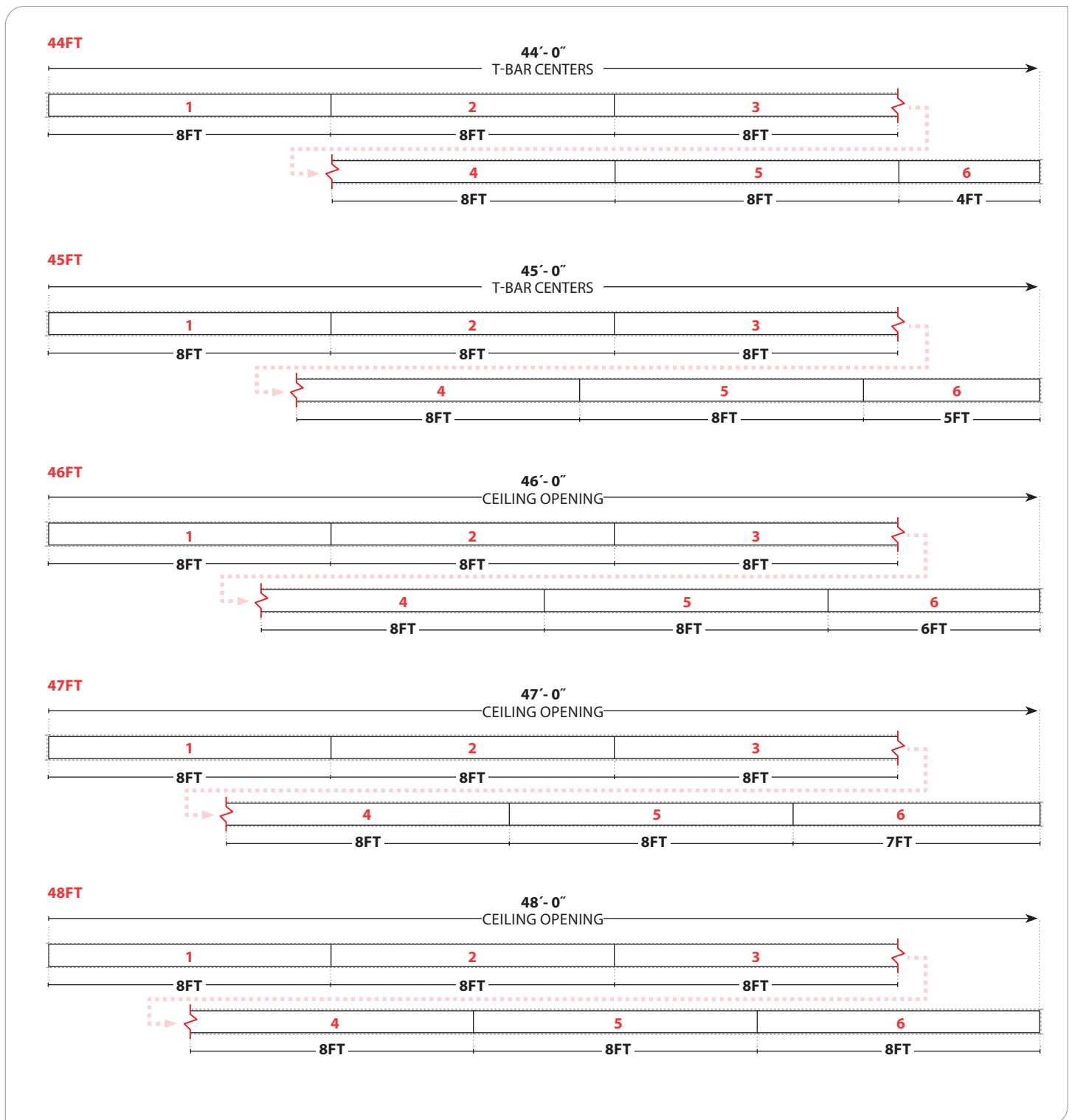

WARNING: Ground fixture in accordance with local and national electrical codes. Failure to do so may result in serious personal injury. Fixture Installations should ONLY be done by a qualified licensed electrical professional.

BionicPro3 | Recessed Linear Light Pocket — X1 (T-Bar)

ROW INSTRUCTIONS

BPR03-REC-FLSH-LP-X1-SC

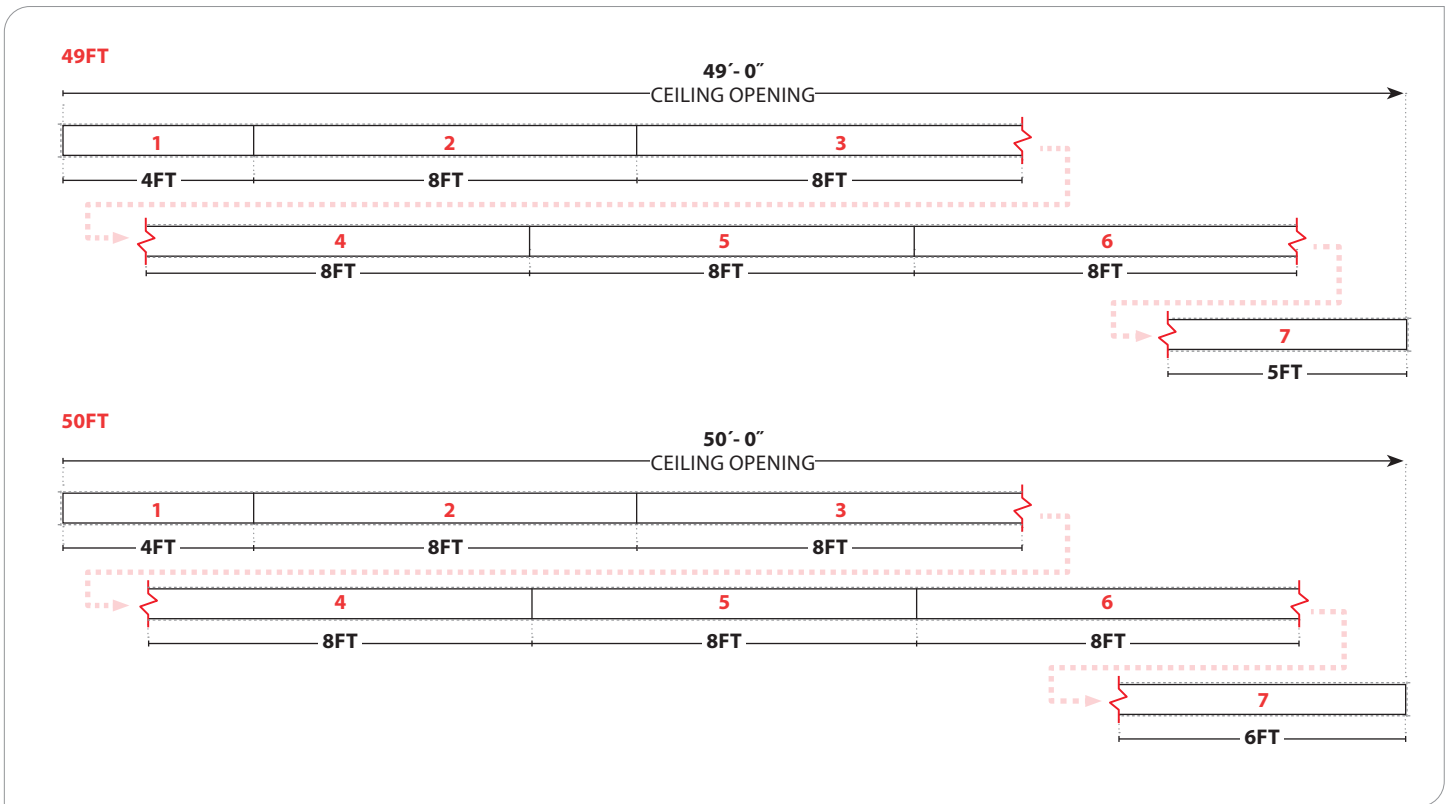

WARNING: Ground fixture in accordance with local and national electrical codes. Failure to do so may result in serious personal injury. Fixture Installations should ONLY be done by a qualified licensed electrical professional.