

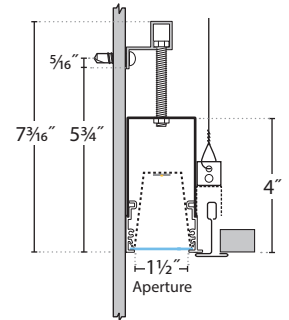

FLSH



FLSH:

UP TO 107 LPW

	LO	MO	SO	HO
SAL Lm/Ft	390	575	790	1000
W/Ft	3.8	5.6	7.8	10.5

LUMEN CHART AT 3500K-80 CRI



Lumen output may vary +/- 5%
Light Loss Factor (LLF) for CCTs other than 3500K:
 4000K +2%, 3000K -5%, 2700K -20%
 90 CRI -15% (3K, 3500K, 4K & 5K)

SERIES	LENS POS.	LED COLOR	OUTPUT	NOMINAL LENGTH	TRIM COLOR	DISTRIBUTION	MOUNTING	CIRCUITING	VOLTAGE	CEILING SYSTEMS	DRIVERS	OPTIONS
QS_BPRO2-PER	FLSH							SC				
QUICKSHIP BionicPro 2™ Perimeter	FLSH Flush Lens	LED27 2700K (90CRI) LED3 3000K LED35 3500K LED4 4000K LED3-90 3000K (90CRI) LED35-90 3500K (90CRI) LED4-90 4000K (90CRI) LED5-90 5000K (90CRI)	LO Low MO Medium SO Standard HO High R (Row Length, 1/16" increments)	2' 3' 4' 5' 6' 7' 8' R	TMW Textured Matte White (Standard) YGW Gloss White YSL Silver (Metallic) YBK Black (Matte)	SAL Satin Lens MGZ Medium Wall Graze PFL Perimeter Room Fill	LP Light Pocket WTW Wall to Wall All non nominal lengths require FIELD CUTTABLE filler fixture at end of row	SC Single Circuit	120 277	X1 1 5/16" T-Bar X1M 9/16" T-Bar X1T 1 5/16" T-Bar Tegular X2 Dimensional T-Bar Armstrong Interlude® X3 Hard Ceiling (Flange Trim) X6 Slot Grid X7 Mud-Over Flange	ND Non-Dimming DM01 0-10v, 1% Dimming (Standard)	EMHE Emergency Battery (800 Delivered Lumens, CA Title 20 compliant, 2" + 3": Non-IC rated, NA with UNV voltage, Adds 1 1/2" height)



FLSH:

SATIN LENS

MEDIUM OUTPUT:

BPRO2-PER-FLSH-LED35-MO-SAL

2300 Delivered Lumens

23 Watts

101 lm/w

3500 CCT

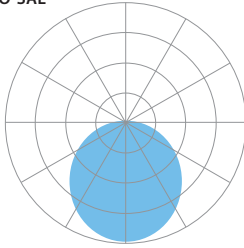

Zonal Lumen Summary:

0-90 = 100%

850

Vertical Angle	0°	25°	45°	65°	90°
0°	850	850	850	850	850
5°	841	842	840	846	852
15°	795	797	798	808	817
25°	715	718	723	739	750
35°	616	618	625	644	657
45°	504	504	513	531	547
55°	382	384	392	407	424
65°	257	259	267	281	295
75°	134	135	143	155	168
85°	21	23	28	38	48
90°	0	0	0	0	0

LUMEN MAINTENANCE

L70 — 200,000+ Hours

L90 — 100,000+ Hours
(LO, MO & SO)

L90 — 60,000+ Hours (HO)

LED SYSTEM

LED modules and drivers are field replaceable.

BINNING

Standard binning (all Prudential LED boards) includes testing at the chip level and board integration to provide consistent color temperature within a 3-step MacAdams ellipse, with +/- 5% lumen output range and +/- .004 Duv.

LABELS

ETL damp labeled and I.B.E.W. manufactured.

ELECTRICAL

Must specify LED dimming controls. LED fixtures have constant current driver(s) with less than 20% THD when loaded to a minimum of 60%. Drivers sink a maximum of 6mA per driver. DM01 LED drivers are 0-10V dimmable and are compatible with most 0-10V wall slide dimmers and direct 0-10V analog signal dimmers.

Max driver size 1.65" w x 1.25" h.

CONSTRUCTION

Housing

Extruded aluminum trim and side wall >25% PC recycled, 100% recyclable.

20-gauge steel top housing >20% PC recycled, 100% recyclable.

Die-Cast endcaps (LP)

Lens

Seamless lens up to 200'. Consult factory for longer lengths. Polymer, 100% recyclable.

Weight

4 lbs./ ft.

MOUNTING

Recessed into drywall or t-bar ceilings or walls.

WARRANTY

Single-source, 5 year limited warranty covers standard components and construction.



CEILING SYSTEMS

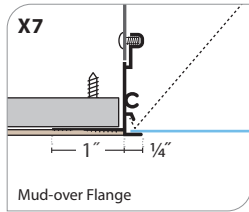
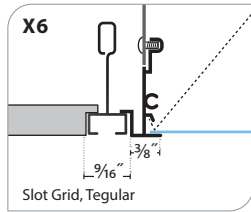
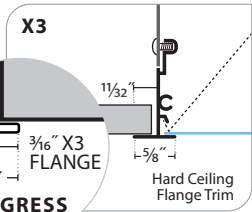
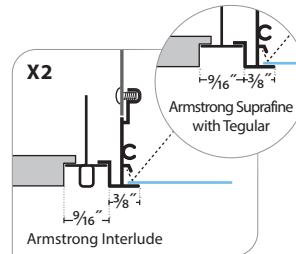
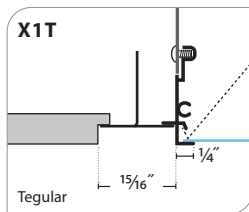
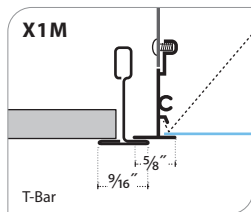
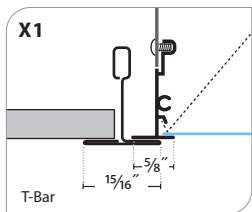

ADJOINING DETAILS

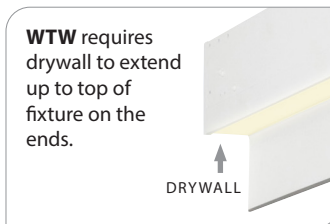
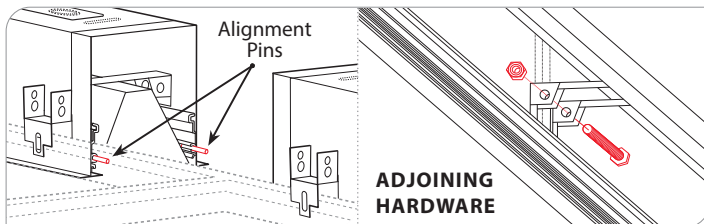

MOUNTING

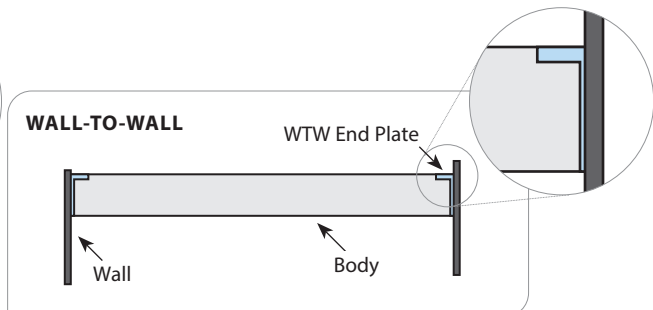
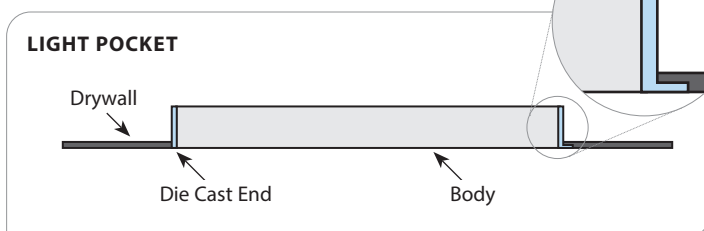

NOTE: LP and WTW odd length fixtures require a field-trimmed Filler fixture.



Medium Wall Graze

Wall grazing performance often better just off a wall.

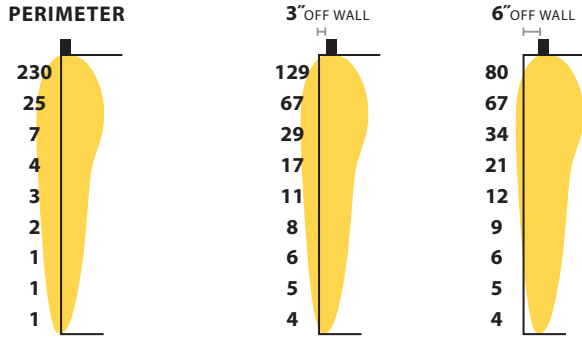

See BionicPro recessed linear specs

Perimeter Fill (PFL)

Wash a corridor in light from one side of the perimeter. Our Perimeter Fill is ideal for hospital corridors where a 50 fc average is needed.

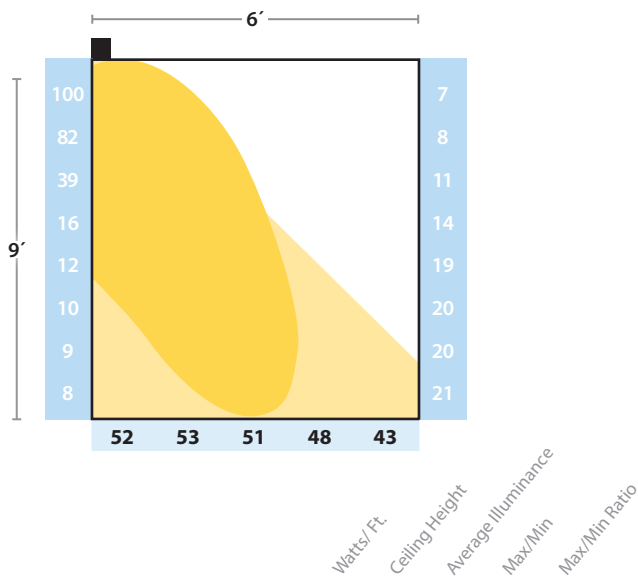

High Output 1050 lumens/ft	1.75	10'	50 fc	53/43	1.2
-------------------------------------	------	-----	--------------	-------	-----



**WALL TO GRID (T-BAR) DIMENSIONS:
CEILING OPENING (HARD CEILING) DIMENSIONS:**

X=	T-BAR (X1, X1M, X1T, X2, X6)	HARD CEILING (X3, X7)	XSR SHADOW REVEAL (OPTIONAL)	
			T-BAR (X1, X1M, X1T, X2, X6)	HARD CEILING (X3, X7)
	2½"	2¾"	2⅝"	2¾"

NOTE: X3 Hard Ceiling with Louver/Regress, fixtures **MUST** be installed before drywall

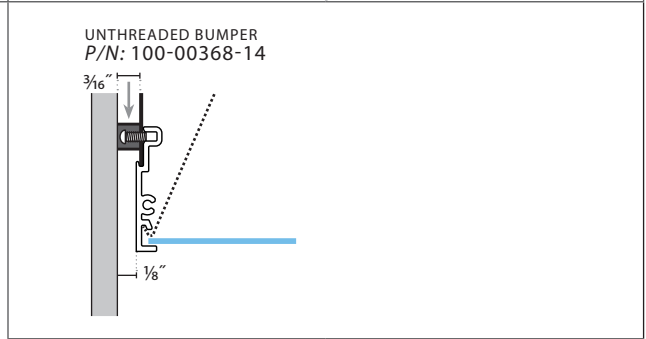
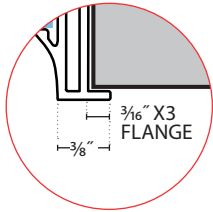

T-BAR — X1, X1M, X1T, X2, X6

HARD CEILING — X3, X7

FLSH:

FLSH:

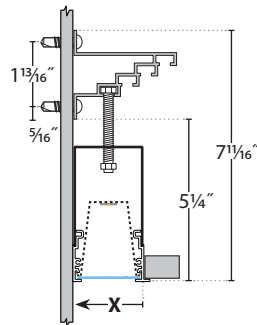
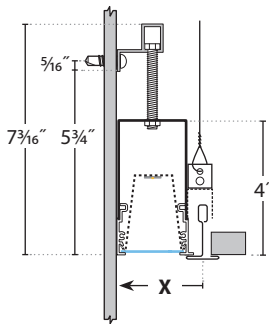



T-BAR — X1, X1M, X1T, X2, X6

LIGHT POCKET (LP):

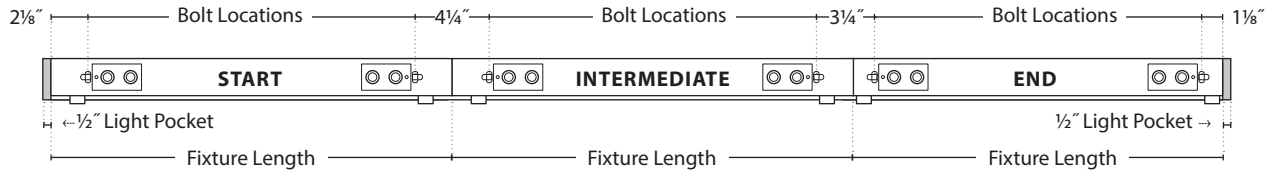

	FIXTURE LENGTHS		BOLT LOCATIONS
	Start / Intermediate	End / Individual	
2'	24"	22"	19 3/4"
3'	36"	34"	31 3/4"
4'	48"	46"	43 3/4"
5'	60"	58"	55 3/4"
6'	72"	70"	67 3/4"
7'	84"	82"	79 3/4"
8'	96"	94"	91 3/4"

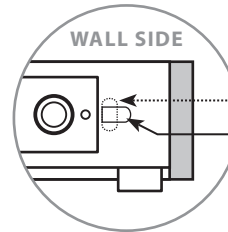
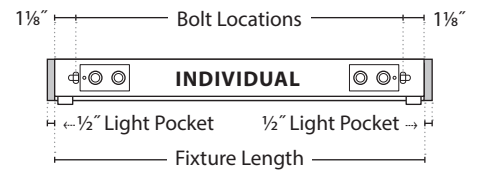

BOLT LOCATIONS
XSR / LOUVER
NON XSR / NON LOUVER

WALL-TO-WALL (WTW):

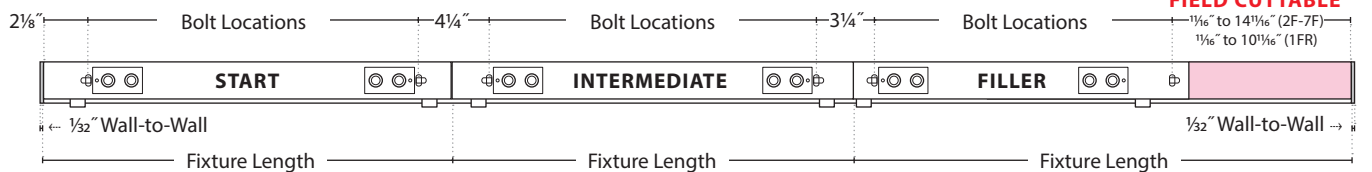

Bolt Locations Range for
FIELD CUTTABLE
1/16" to 14 1/16" (2F-7F)
1/16" to 10 1/16" (1FR)

	FIXTURE LENGTH		BOLT LOCATIONS	
	Start / Intermediate	Filler	Start / Intermediate	Filler
—	—	—	—	—
2'	24"	16"-26"	19 3/4"	14 1/8"
3'	36"	24"-38"	31 3/4"	22 1/8"
4'	48"	36"-50"	43 3/4"	34 1/8"
5'	60"	48"-62"	55 3/4"	46 1/8"
6'	72"	60"-74"	67 3/4"	58 1/8"
7'	84"	72"-86"	79 3/4"	70 1/8"
8'	96"	84"-98"	91 3/4"	82 1/8"

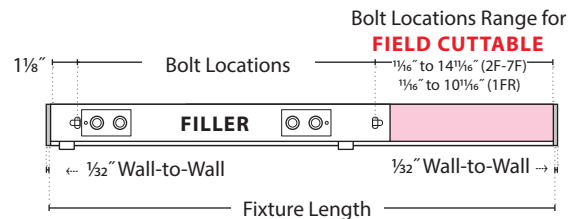

Bolt Locations Range for
FIELD CUTTABLE
1/16" to 14 1/16" (2F-7F)
1/16" to 10 1/16" (1FR)

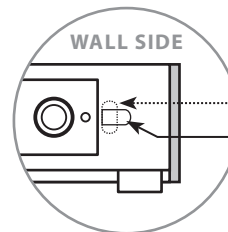

BOLT LOCATIONS
XSR / LOUVER
NON XSR / NON LOUVER

POWER FEED LOCATIONS:

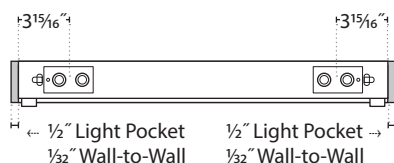



HARD CEILING — X3, X7

LIGHT POCKET (LP):

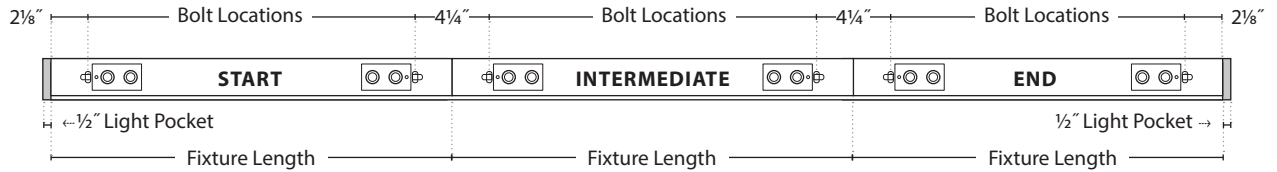

	FIXTURE LENGTHS				BOLT LOCATIONS			
	Start	Intermediate	End	Individual	Start	Intermediate	End	Individual
2'	24"				19 3/4"			
3'	36"				31 3/4"			
4'	48"				43 3/4"			
5'	60"				55 3/4"			
6'	72"				67 3/4"			
7'	84"				79 3/4"			
8'	96"				91 3/4"			

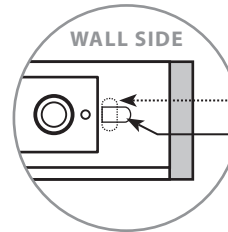
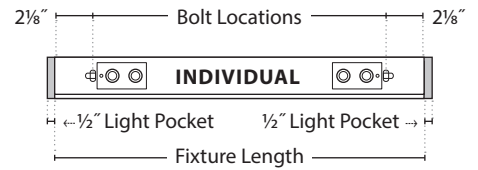

BOLT LOCATIONS
XSR / LOUVER
NON XSR / NON LOUVER

WALL-TO-WALL (WTW):

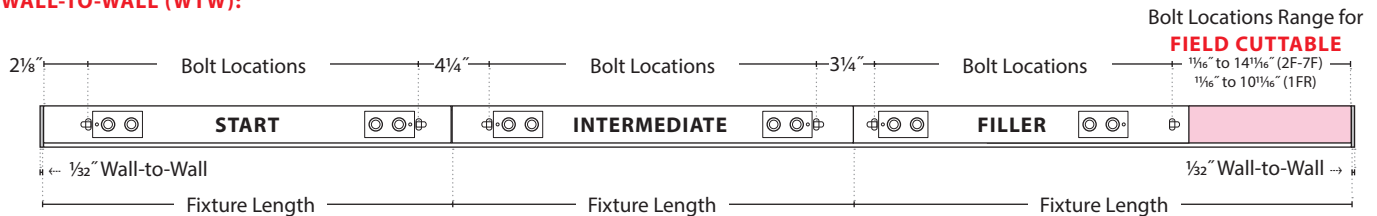

	FIXTURE LENGTH		BOLT LOCATIONS	
	Start / Intermediate	Filler	Start / Intermediate	Filler
—	—	—	—	—
2'	24"	16" - 26"	19 3/4"	14 1/8"
3'	36"	24" - 38"	31 3/4"	22 1/8"
4'	48"	36" - 50"	43 3/4"	34 1/8"
5'	60"	48" - 62"	55 3/4"	46 1/8"
6'	72"	60" - 74"	67 3/4"	58 1/8"
7'	84"	72" - 86"	79 3/4"	70 1/8"
8'	96"	84" - 98"	91 3/4"	82 1/8"

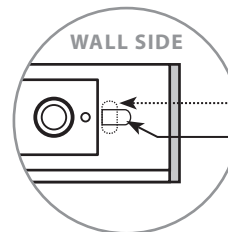
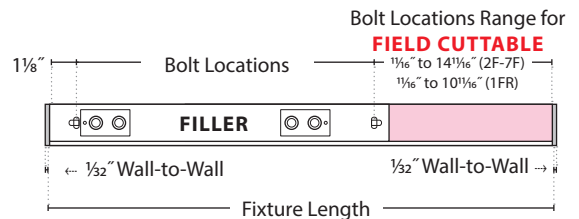

BOLT LOCATIONS
XSR / LOUVER
NON XSR / NON LOUVER

POWER FEED LOCATIONS:

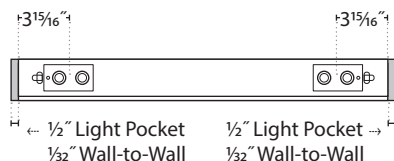

HARD CEILING
LENS INSTALL
VIDEO



ROW BUILDER

LIGHT POCKET (LP):

ROW LENGTH	FIXTURE ROW
9'	4FT STR + 5FT END
10'	4FT STR + 6FT END
11'	4FT STR + 7FT END
12'	8FT STR + 4FT END
13'	8FT STR + 5FT END
14'	8FT STR + 6FT END
15'	8FT STR + 7FT END
16'	8FT STR + 8FT END
17'	4FT STR + (1) 8FT INT + 5FT END
18'	4FT STR + (1) 8FT INT + 6FT END
19'	4FT STR + (1) 8FT INT + 7FT END
20'	8FT STR + (1) 8FT INT + 4FT END
21'	8FT STR + (1) 8FT INT + 5FT END
22'	8FT STR + (1) 8FT INT + 6FT END
23'	8FT STR + (1) 8FT INT + 7FT END
24'	8FT STR + (1) 8FT INT + 8FT END
25'	4FT STR + (2) 8FT INT + 5FT END
26'	4FT STR + (2) 8FT INT + 6FT END
27'	4FT STR + (2) 8FT INT + 7FT END
28'	8FT STR + (2) 8FT INT + 4FT END
29'	8FT STR + (2) 8FT INT + 5FT END
30'	8FT STR + (2) 8FT INT + 6FT END
31'	8FT STR + (2) 8FT INT + 7FT END
32'	8FT STR + (2) 8FT INT + 8FT END
33'	4FT STR + (3) 8FT INT + 5FT END
34'	4FT STR + (3) 8FT INT + 6FT END
35'	4FT STR + (3) 8FT INT + 7FT END
36'	8FT STR + (3) 8FT INT + 4FT END
37'	8FT STR + (3) 8FT INT + 5FT END
38'	8FT STR + (3) 8FT INT + 6FT END
39'	8FT STR + (3) 8FT INT + 7FT END
40'	8FT STR + (3) 8FT INT + 8FT END
41'	4FT STR + (4) 8FT INT + 5FT END
42'	4FT STR + (4) 8FT INT + 6FT END
43'	4FT STR + (4) 8FT INT + 7FT END
44'	8FT STR + (4) 8FT INT + 4FT END
45'	8FT STR + (4) 8FT INT + 5FT END
46'	8FT STR + (4) 8FT INT + 6FT END
47'	8FT STR + (4) 8FT INT + 7FT END
48'	8FT STR + (4) 8FT INT + 8FT END
49'	4FT STR + (5) 8FT INT + 5FT END
50'	4FT STR + (5) 8FT INT + 6FT END

WALL-TO-WALL (WTW):

ROW LENGTH	FIXTURE ROW	MINIMUM FILLER LENGTH	MAXIMUM FILLER LENGTH
9'	4FT STR + 4FT FILLER	8' - 0" (96")	9' - 2" (110")
10'	4FT STR + 5FT FILLER	9' - 0" (108")	10' - 2" (122")
11'	4FT STR + 6FT FILLER	10' - 0" (120")	11' - 2" (134")
12'	4FT STR + 7FT FILLER	11' - 0" (132")	12' - 2" (146")
13'	8FT STR + 4FT FILLER	12' - 0" (144")	13' - 2" (158")
14'	8FT STR + 5FT FILLER	13' - 0" (156")	14' - 2" (170")
15'	8FT STR + 6FT FILLER	14' - 0" (168")	15' - 2" (182")
16'	8FT STR + 7FT FILLER	15' - 0" (180")	16' - 2" (194")
17'	4FT STR + (1) 8FT INT + 4FT FILLER	16' - 0" (192")	17' - 2" (206")
18'	4FT STR + (1) 8FT INT + 5FT FILLER	17' - 0" (204")	18' - 2" (218")
19'	4FT STR + (1) 8FT INT + 6FT FILLER	18' - 0" (216")	19' - 2" (230")
20'	4FT STR + (1) 8FT INT + 7FT FILLER	19' - 0" (228")	20' - 2" (242")
21'	8FT STR + (1) 8FT INT + 4FT FILLER	20' - 0" (240")	21' - 2" (254")
22'	8FT STR + (1) 8FT INT + 5FT FILLER	21' - 0" (252")	22' - 2" (266")
23'	8FT STR + (1) 8FT INT + 6FT FILLER	22' - 0" (264")	23' - 2" (278")
24'	8FT STR + (1) 8FT INT + 7FT FILLER	23' - 0" (276")	24' - 2" (290")
25'	4FT STR + (2) 8FT INT + 4FT FILLER	24' - 0" (288")	25' - 2" (302")
26'	4FT STR + (2) 8FT INT + 5FT FILLER	25' - 0" (300")	26' - 2" (314")
27'	4FT STR + (2) 8FT INT + 6FT FILLER	26' - 0" (312")	27' - 2" (326")
28'	4FT STR + (2) 8FT INT + 7FT FILLER	27' - 0" (324")	28' - 2" (338")
29'	8FT STR + (2) 8FT INT + 4FT FILLER	28' - 0" (336")	29' - 2" (350")
30'	8FT STR + (2) 8FT INT + 5FT FILLER	29' - 0" (348")	30' - 2" (362")
31'	8FT STR + (2) 8FT INT + 6FT FILLER	30' - 0" (360")	31' - 2" (374")
32'	8FT STR + (2) 8FT INT + 7FT FILLER	31' - 0" (372")	32' - 2" (386")
33'	4FT STR + (3) 8FT INT + 4FT FILLER	32' - 0" (384")	33' - 2" (398")
34'	4FT STR + (3) 8FT INT + 5FT FILLER	33' - 0" (396")	34' - 2" (410")
35'	4FT STR + (3) 8FT INT + 6FT FILLER	34' - 0" (408")	35' - 2" (422")
36'	4FT STR + (3) 8FT INT + 7FT FILLER	35' - 0" (420")	36' - 2" (434")
37'	8FT STR + (3) 8FT INT + 4FT FILLER	36' - 0" (432")	37' - 2" (446")
38'	8FT STR + (3) 8FT INT + 5FT FILLER	37' - 0" (444")	38' - 2" (458")
39'	8FT STR + (3) 8FT INT + 6FT FILLER	38' - 0" (456")	39' - 2" (470")
40'	8FT STR + (3) 8FT INT + 7FT FILLER	39' - 0" (468")	40' - 2" (482")
41'	4FT STR + (4) 8FT INT + 4FT FILLER	40' - 0" (480")	41' - 2" (494")
42'	4FT STR + (4) 8FT INT + 5FT FILLER	41' - 0" (492")	42' - 2" (506")
43'	4FT STR + (4) 8FT INT + 6FT FILLER	42' - 0" (504")	43' - 2" (518")
44'	4FT STR + (4) 8FT INT + 7FT FILLER	43' - 0" (516")	44' - 2" (530")
45'	8FT STR + (4) 8FT INT + 4FT FILLER	44' - 0" (528")	45' - 2" (542")
46'	8FT STR + (4) 8FT INT + 5FT FILLER	45' - 0" (540")	46' - 2" (554")
47'	8FT STR + (4) 8FT INT + 6FT FILLER	46' - 0" (552")	47' - 2" (566")
48'	8FT STR + (4) 8FT INT + 7FT FILLER	47' - 0" (564")	48' - 2" (578")
49'	4FT STR + (5) 8FT INT + 4FT FILLER	48' - 0" (576")	49' - 2" (590")
50'	4FT STR + (5) 8FT INT + 5FT FILLER	49' - 0" (588")	50' - 2" (602")



FILLER FIXTURES

1FR (REMOTE DRIVER):

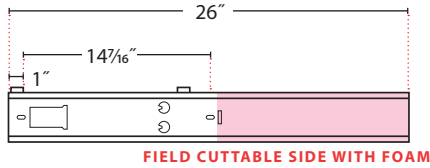

FIELD CUTTABLE SIDE WITH FOAM

2F:

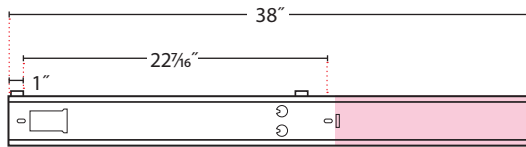

FIELD CUTTABLE SIDE WITH FOAM

3F:

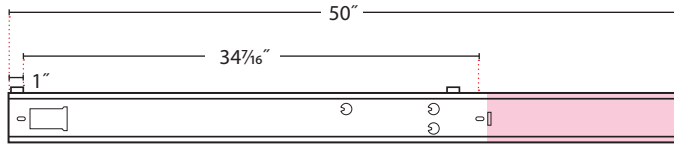

FIELD CUTTABLE SIDE WITH FOAM

4F:

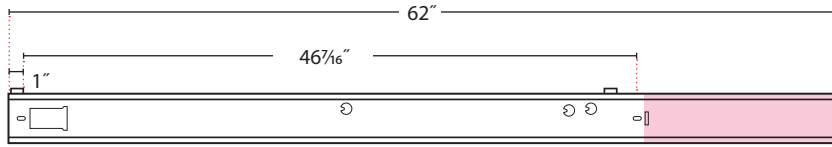

FIELD CUTTABLE SIDE WITH FOAM

5F:

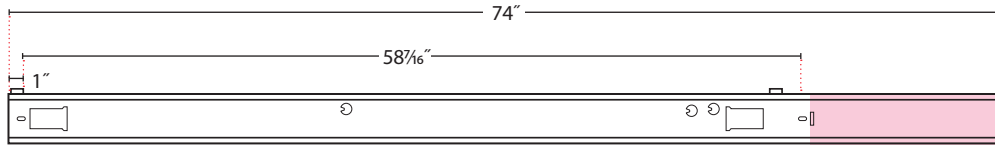

FIELD CUTTABLE SIDE WITH FOAM

6F:

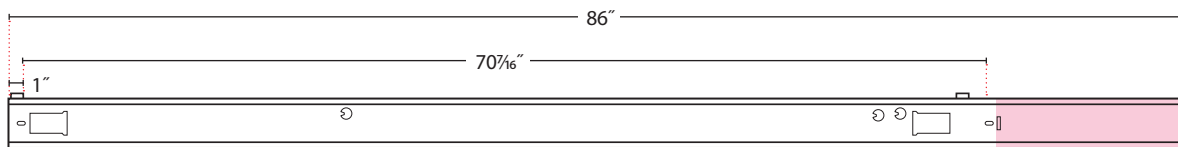

FIELD CUTTABLE SIDE WITH FOAM

7F:

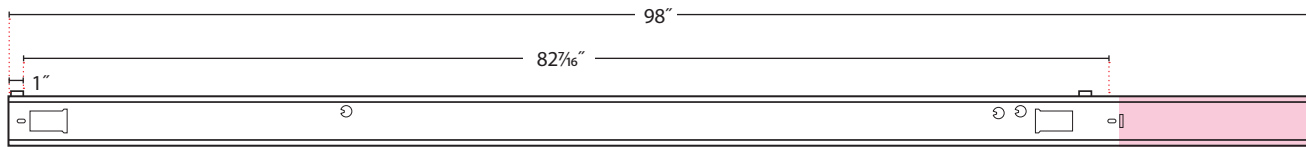

FIELD CUTTABLE SIDE WITH FOAM

- Telescoping 2' – 8' fixtures. Fixtures adjust in length: 2' to 3', 4' to 5', 7' to 8', etc.
- Looks like a custom length fixture:
7' 8" = one field-adjusted fixture, no trim seams (seamless lens).
- Optical performance identical to standard fixtures.
- Much lower cost for wall-to-wall installs (one less fixture).
- Way easier installs, one cut, no assembly, installs like a standard fixture.



FILLER FIXTURE VIDEO

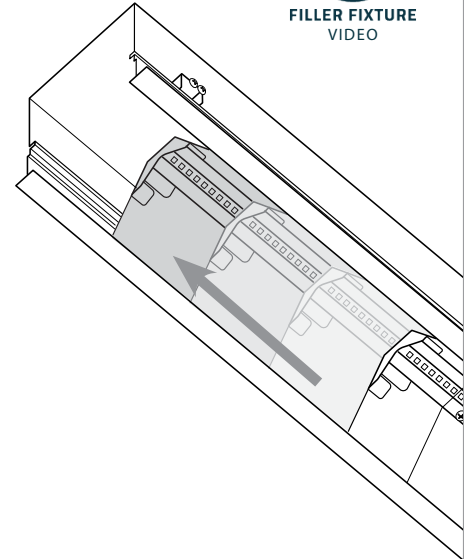

POWER ACCESS PLATE 1/4-20 MOUNTING HOLES



LM79 & TM30 DATA:

	MEASURED CCT	MEASURED LUMENS	CRI	R9	DuV	SPD	TM30 — COLOR VECTOR	TM30 — COLOR DISTORTION
LED27	2680	80%	93	58	0.001		 89 Rf	 97 Rg
LED3	3042	95%	82	6	0.001		 81 Rf	 92 Rg
LED3-90	3016	85%	93	61	0.000		 88 Rf	 96 Rg
LED35	3482	100%	82	3	0.002		 81 Rf	 92 Rg
LED35-90	3417	85%	93	67	0.000		 88 Rf	 96 Rg
LED4	3952	102%	82	4	0.003		 81 Rf	 92 Rg
LED4-90	3882	85%	92	67	0.003		 87 Rf	 96 Rg
LED5-90	4889	85%	94	84	0.002		 86 Rf	 95 Rg