

BionicPro2 | Recessed Linear Light Pocket — X3 (Hard Ceiling)

ROW INSTRUCTIONS

BPRO2-REC-FLSH-LP-X3-SC



PRUDENTIAL LTG.

PRULITE.COM 213.746.0360

GENERAL SPECIFICATIONS

- **DRIVER:** UL recognized electronic drivers.
DM01 = 0-10v 1% Dimming.
ND = NON-DIMMING.
FIXTURE INPUT WATTS PER 4' SECTION =
LO = 15w, MO = 22w, SO = 31w, HO = 42w.
- **SC** = Single Circuit.
- **EMHE** = Emergency Battery Pack (CA Title 20 compliant)
- **IC RATING:** Fixtures are IC Rated unless Insulation Detector is factory-installed. (Insulation Detector requires 120 or 277 voltage).
- **LABELS:** ETL LED luminaires (conforms to UL 1598).
- **FINISH (POWDER COAT):**
TMW = Textured Matte White. YGW = Gloss White.
YSL = Silver (Metallic). YBK = Black (Matte).
- **LED BOARDS:** LED27 = 2700K, LED3 = 3000K, LED35 = 3500K, LED4 = 4000K, LED5 = 5000K (-90 = 90CRI).
- **REFLECTORS:** Die-formed #24 GA. White Optics M16.
- **LENS:** Composite polymer.
SAL = Satin Acrylic, BTW = Batwing.
- **HOUSING:** Die-formed #20 GA. cold rolled steel.
- **CIRCUIT ASSEMBLY:** Prudential Ltg. reserves the right to change Circuit Assemblies from #16 gauge to #12 gauge, as needed.

NOTES

- Seamless composite lens is shipped rolled in bulk, contractor to cut to size and install.
- All dimensions shown include (2) 1/2" thick finish plates.
- Individual fixtures not intended for continuous row mounting.
- Symbol  indicates emergency fixture location.
- Submittal drawings are used for review purposes only. (Go to prulite.com for installation instructions).

END PLATE DIMENSIONS —

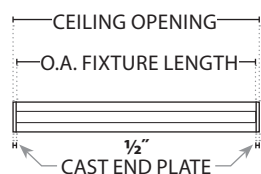

EMHE ACCESSORY PLATE —

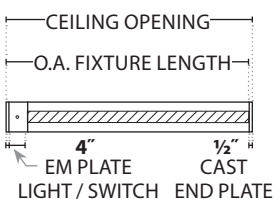

CROSS SECTIONS

SEE SPEC SHEET FOR ADDITIONAL HARD CEILINGS

X3 —

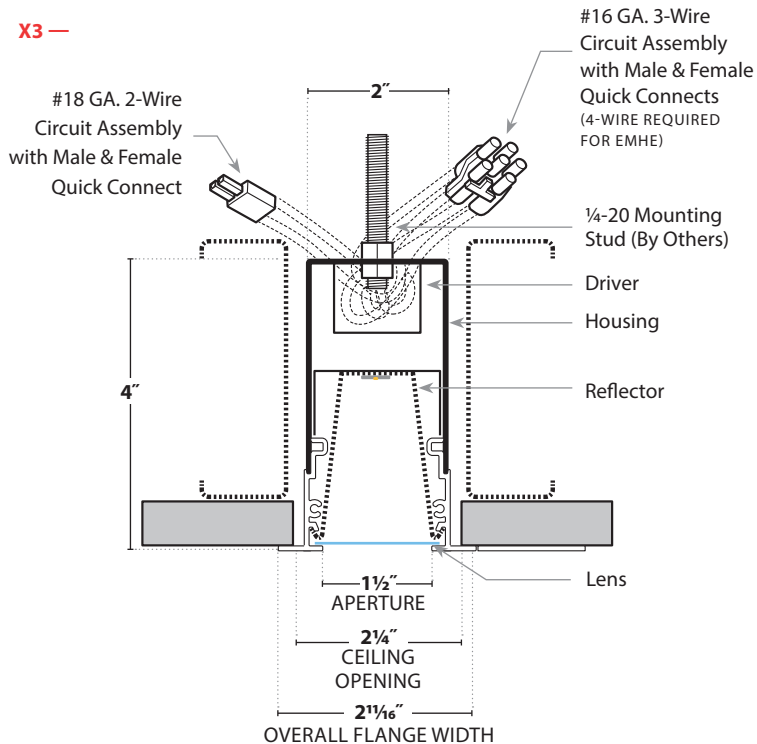

INSULATION DETECTOR / EMHE —

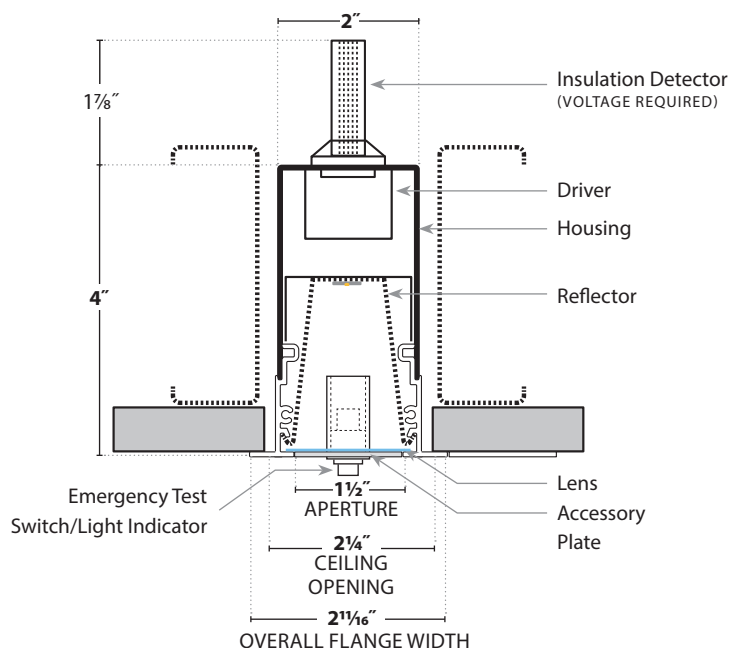

WARNING: Ground fixture in accordance with local and national electrical codes. Failure to do so may result in serious personal injury. Fixture Installations should ONLY be done by a qualified licensed electrical professional.



Prudential Ltg. reserves the right to change design specifications or materials without notice. Please visit prulite.com for most current data. © 2025 All rights reserved – All products manufactured at: Prudential Ltg. 1774 E. 21st Street, Los Angeles, CA 90058

BionicPro2 | Recessed Linear Light Pocket — X3 (Hard Ceiling)

ROW INSTRUCTIONS

BPR02-REC-FLSH-LP-X3-SC

TO REQUEST EMERGENCY FIXTURES:

- Use the fixture number (shown here in red) 17' row with EMHE on Fixtures 1 and 3.
- OR**
- Print out layout and circle where emergency is needed and send in with your order.

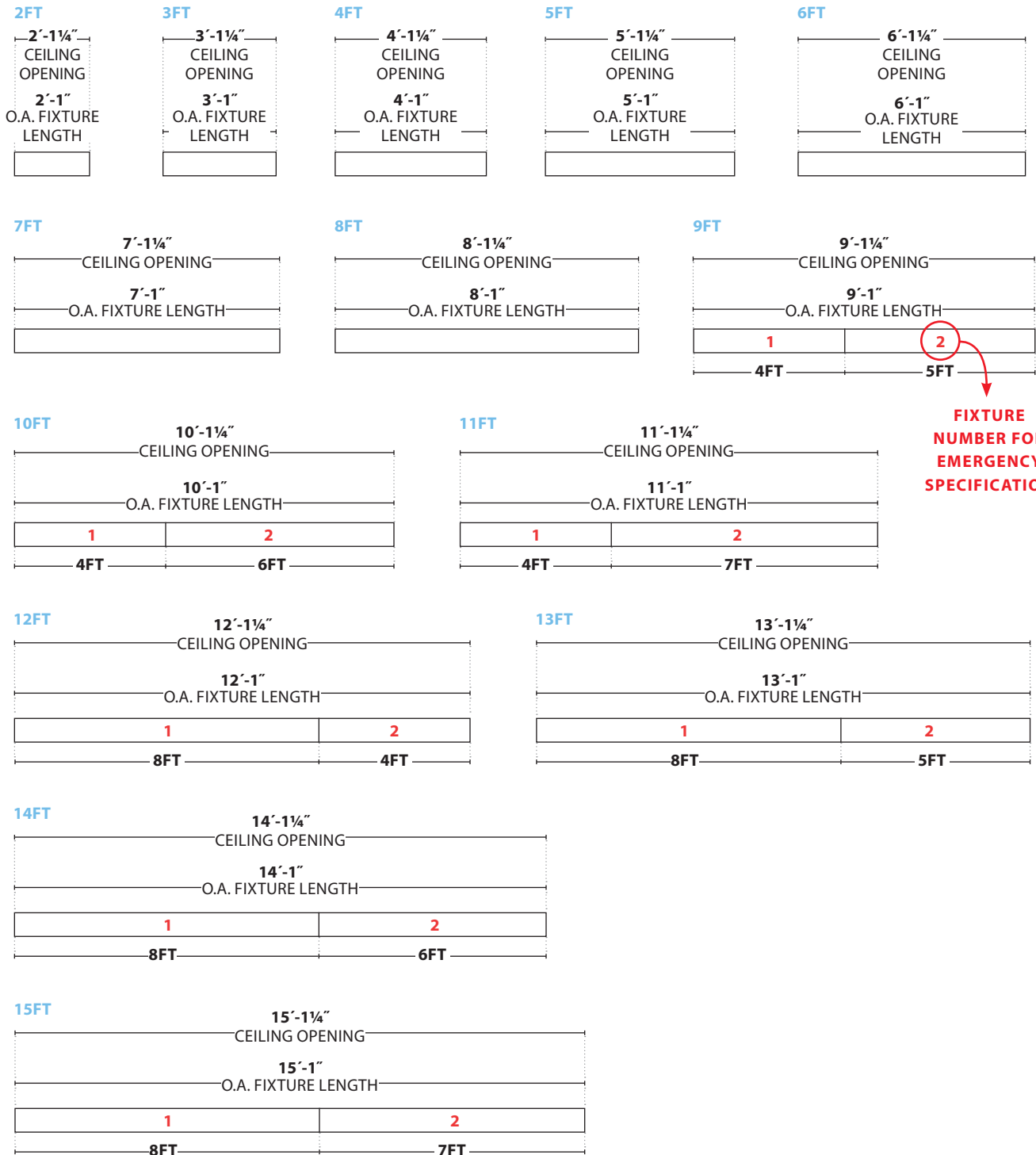

WARNING: Ground fixture in accordance with local and national electrical codes. Failure to do so may result in serious personal injury. Fixture Installations should ONLY be done by a qualified licensed electrical professional.

BionicPro2 | Recessed Linear Light Pocket — X3 (Hard Ceiling)

ROW INSTRUCTIONS

BPRO2-REC-FLSH-LP-X3-SC

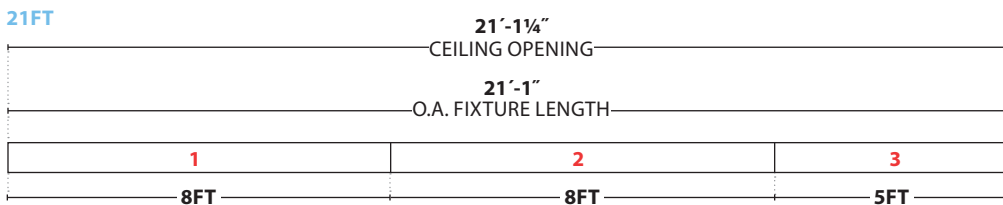
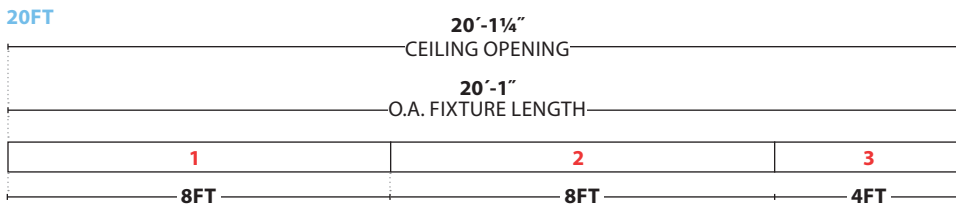
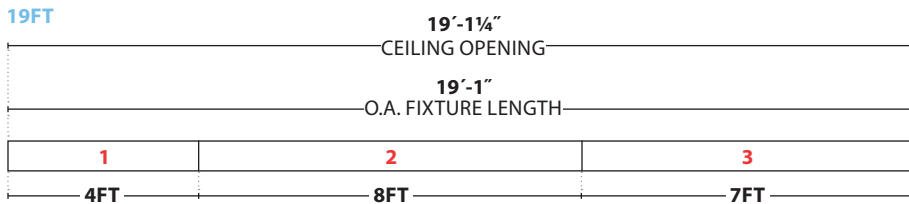
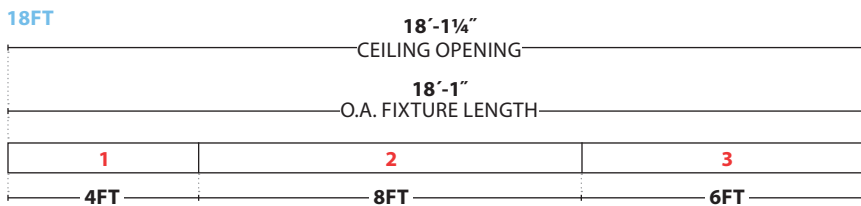
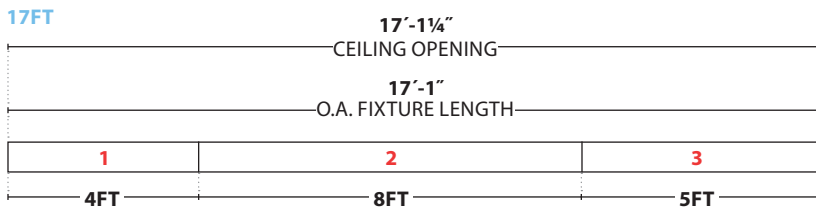
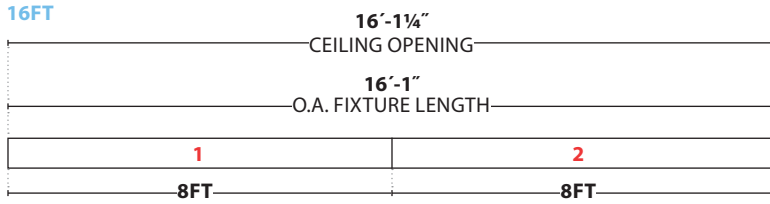

WARNING: Ground fixture in accordance with local and national electrical codes. Failure to do so may result in serious personal injury. Fixture Installations should ONLY be done by a qualified licensed electrical professional.

BionicPro2 | Recessed Linear Light Pocket — X3 (Hard Ceiling)

ROW INSTRUCTIONS

BPR02-REC-FLSH-LP-X3-SC

22FT

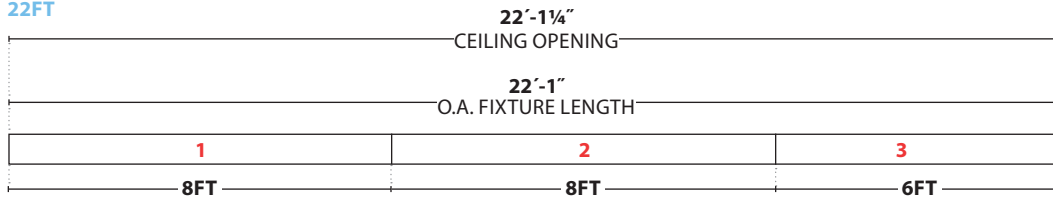

23FT

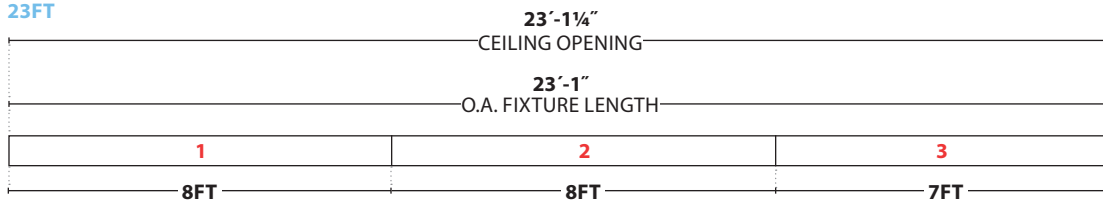

24FT

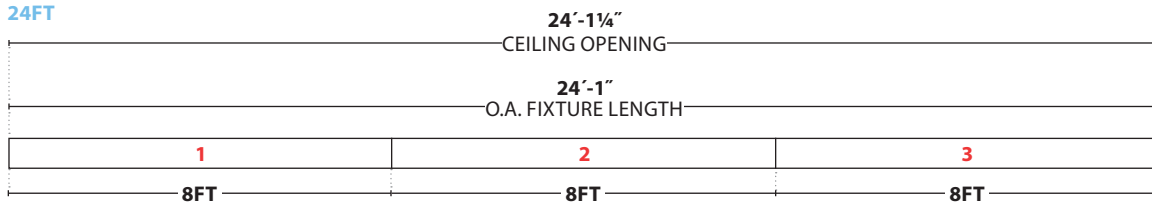

25FT

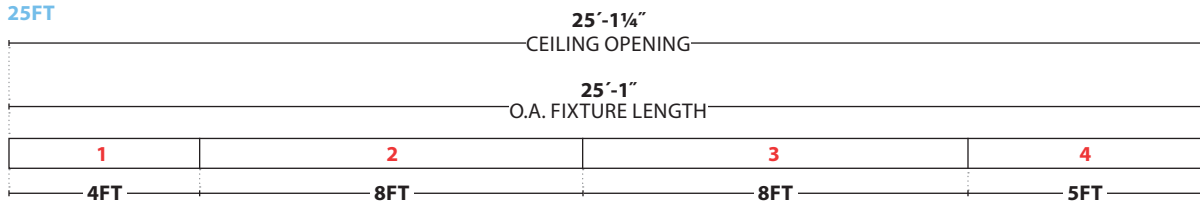

26FT

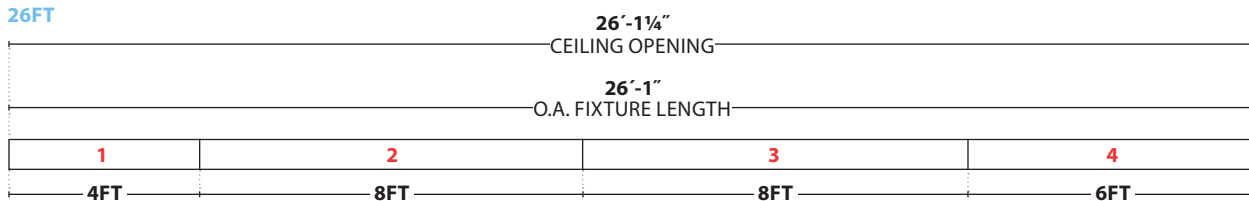

27FT

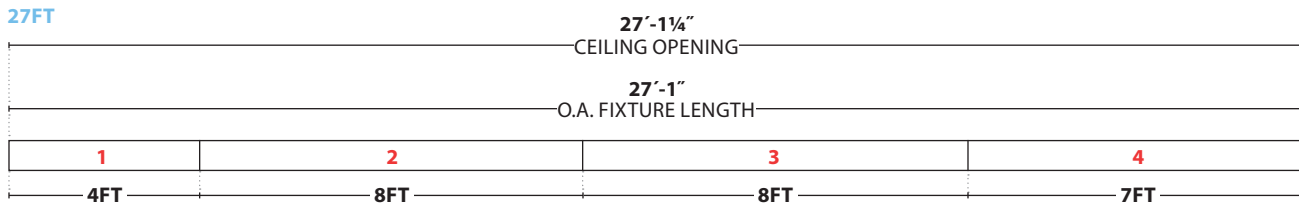

WARNING: Ground fixture in accordance with local and national electrical codes. Failure to do so may result in serious personal injury. Fixture Installations should ONLY be done by a qualified licensed electrical professional.

BionicPro2 | Recessed Linear Light Pocket — X3 (Hard Ceiling)

ROW INSTRUCTIONS

BPR02-REC-FLSH-LP-X3-SC

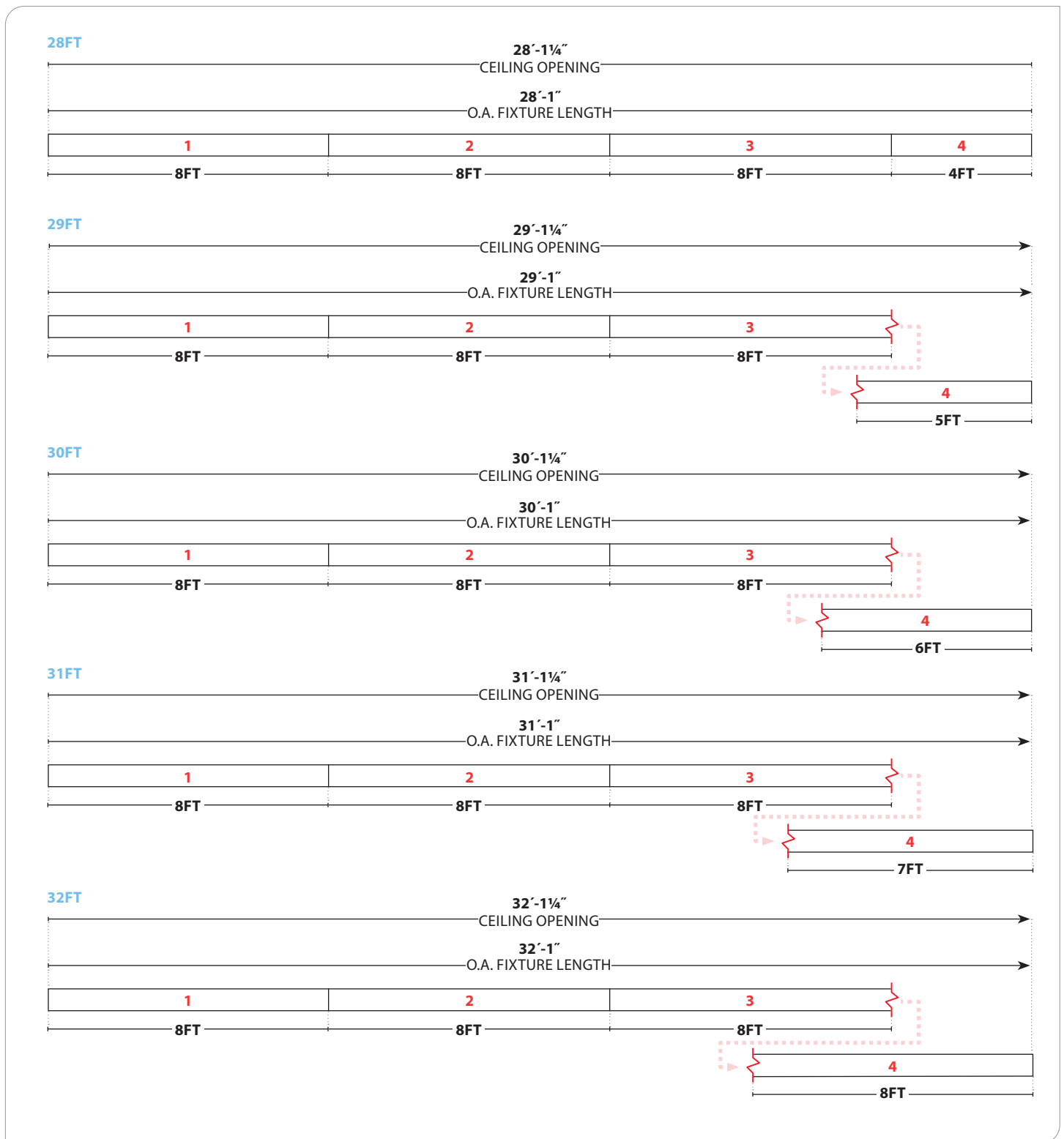

WARNING: Ground fixture in accordance with local and national electrical codes. Failure to do so may result in serious personal injury. Fixture installations should ONLY be done by a qualified licensed electrical professional.

BionicPro2 | Recessed Linear Light Pocket — X3 (Hard Ceiling)

ROW INSTRUCTIONS

BPR02-REC-FLSH-LP-X3-SC

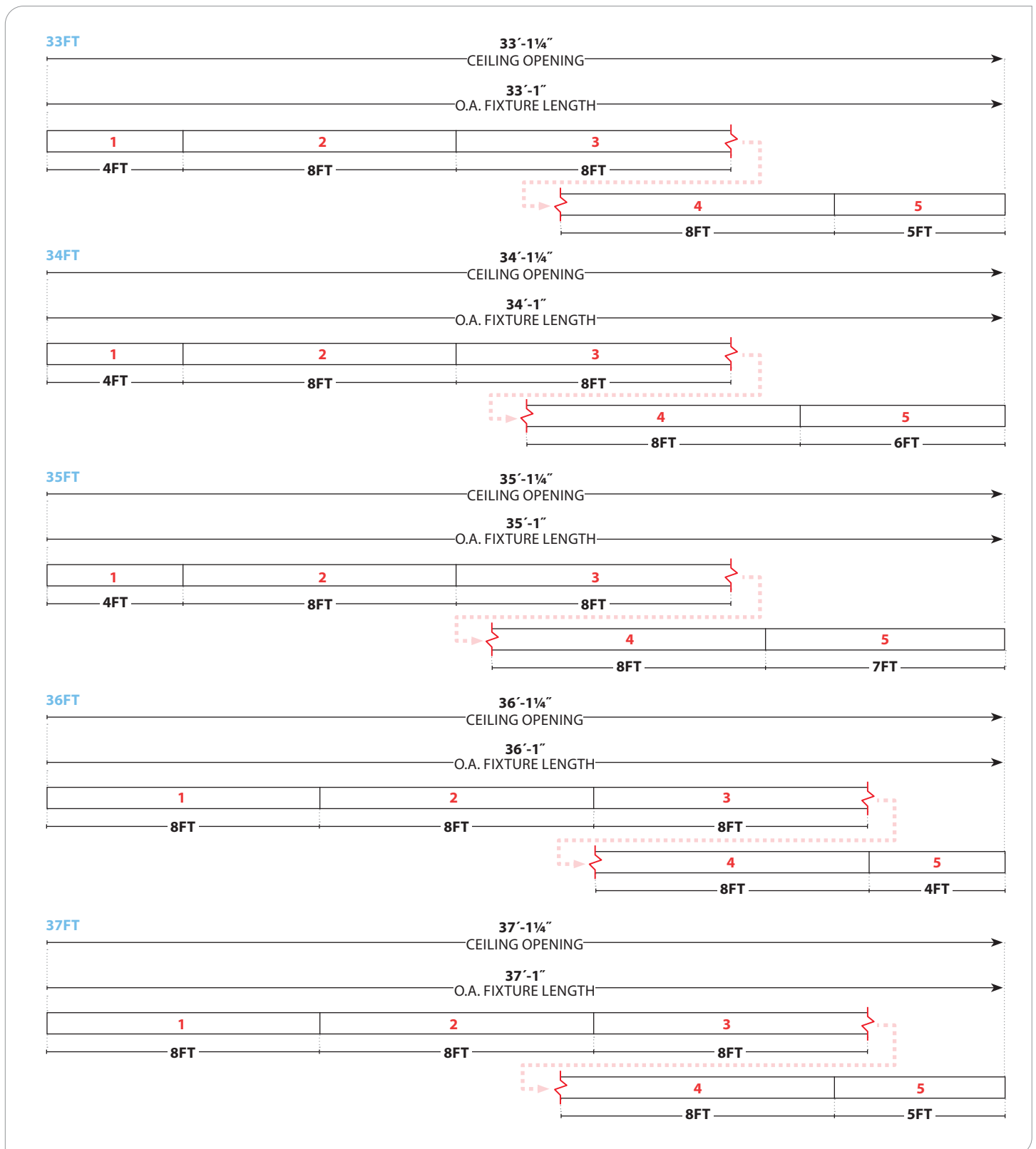

WARNING: Ground fixture in accordance with local and national electrical codes. Failure to do so may result in serious personal injury. Fixture installations should ONLY be done by a qualified licensed electrical professional.

BionicPro2 | Recessed Linear Light Pocket — X3 (Hard Ceiling)

ROW INSTRUCTIONS

BPR02-REC-FLSH-LP-X3-SC

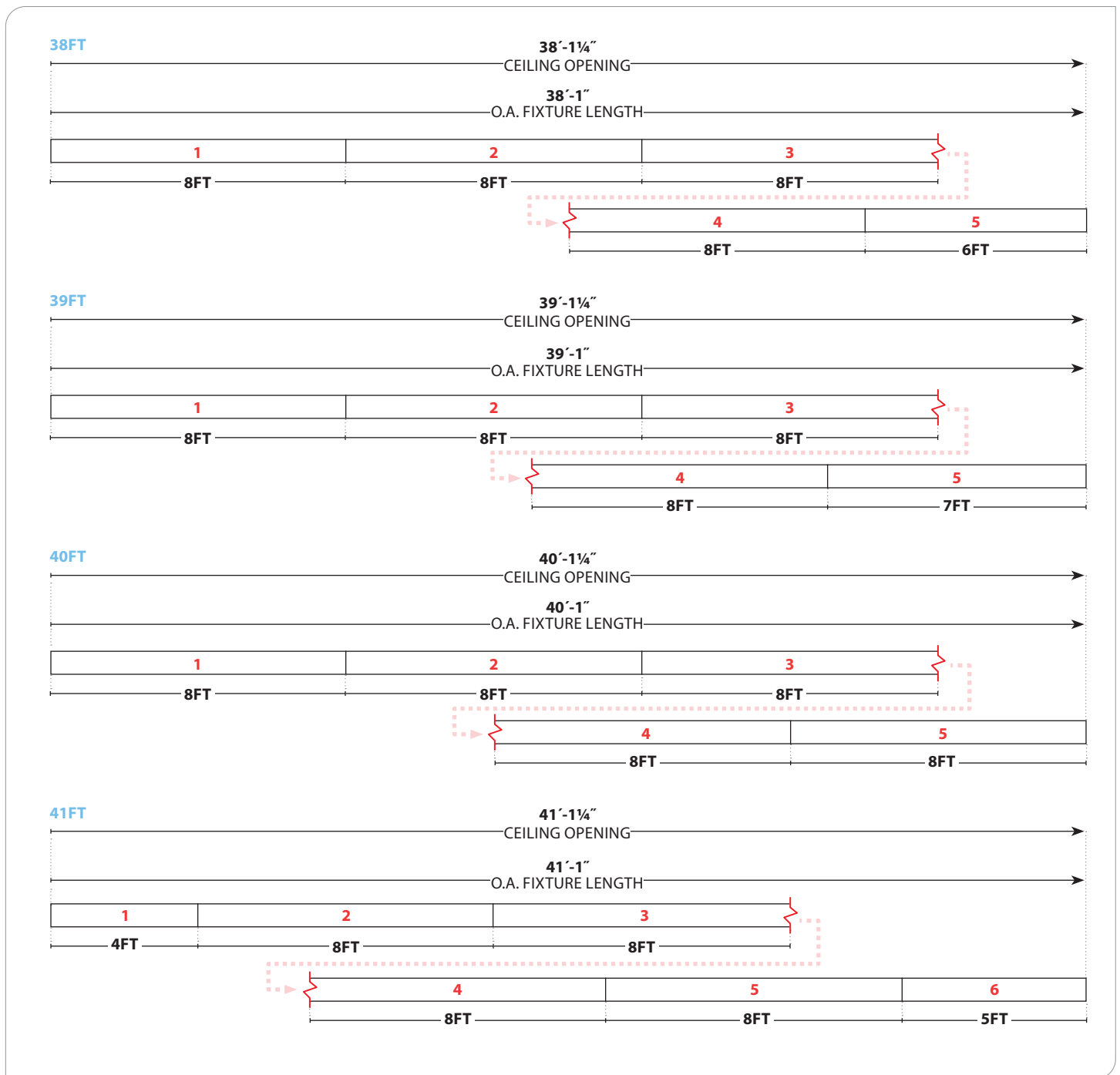

WARNING: Ground fixture in accordance with local and national electrical codes. Failure to do so may result in serious personal injury. Fixture installations should ONLY be done by a qualified licensed electrical professional.

BionicPro2 | Recessed Linear Light Pocket — X3 (Hard Ceiling)

ROW INSTRUCTIONS

BPR02-REC-FLSH-LP-X3-SC

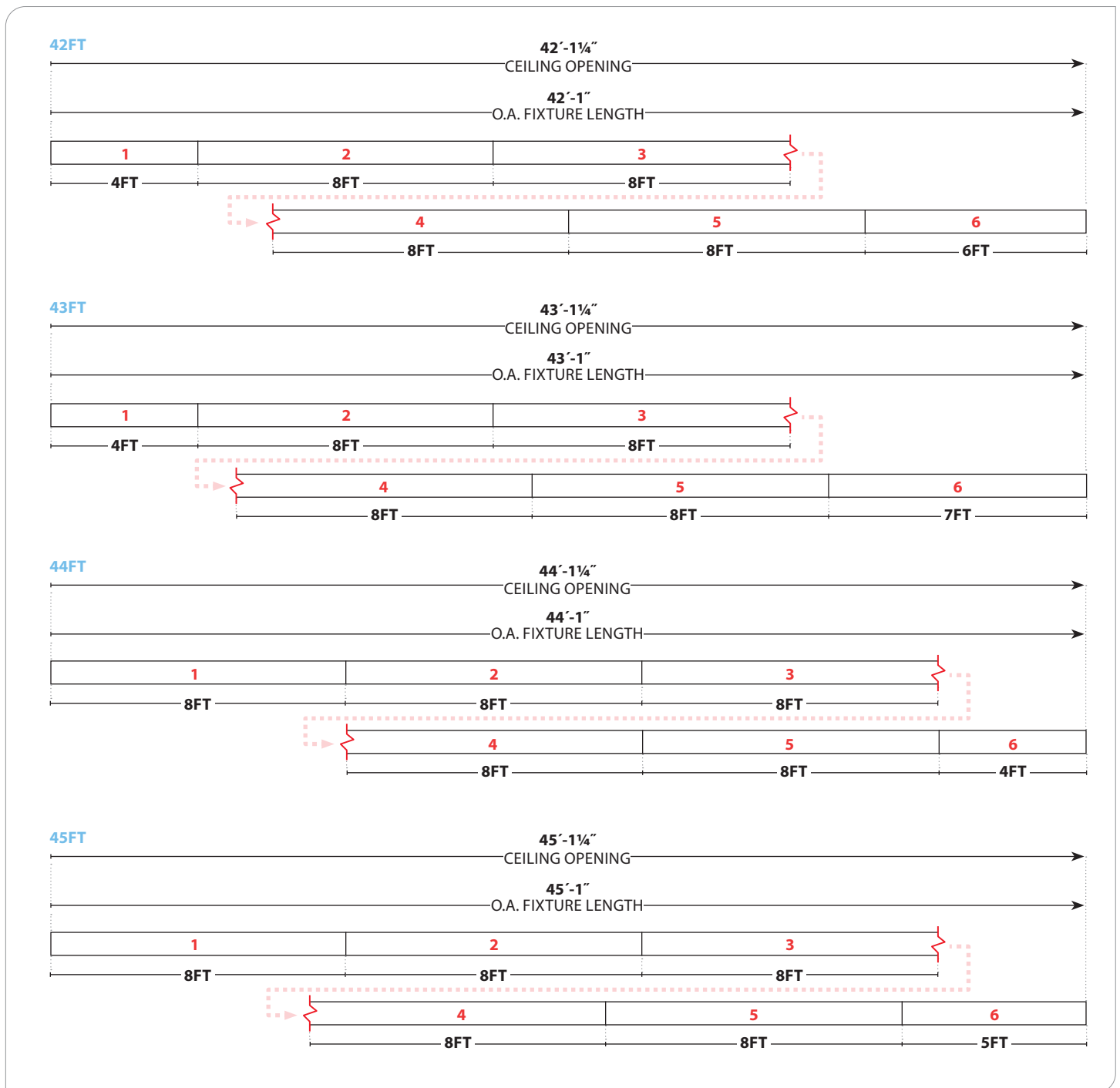

WARNING: Ground fixture in accordance with local and national electrical codes. Failure to do so may result in serious personal injury. Fixture Installations should ONLY be done by a qualified licensed electrical professional.

BionicPro2 | Recessed Linear Light Pocket — X3 (Hard Ceiling)

ROW INSTRUCTIONS

BPR02-REC-FLSH-LP-X3-SC

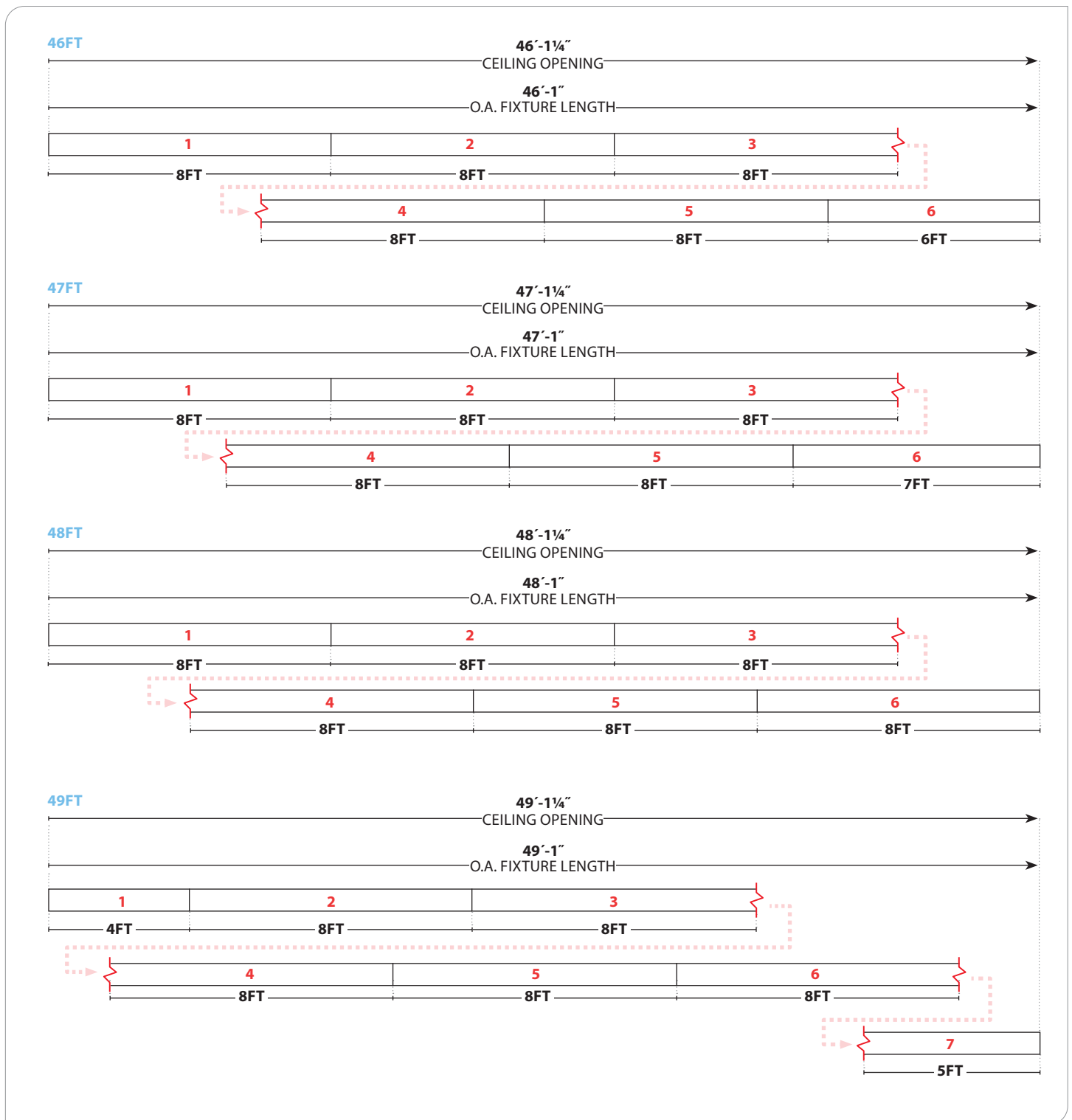

WARNING: Ground fixture in accordance with local and national electrical codes. Failure to do so may result in serious personal injury. Fixture installations should ONLY be done by a qualified licensed electrical professional.

BionicPro2 | Recessed Linear Light Pocket — X3 (Hard Ceiling)

ROW INSTRUCTIONS

BPR02-REC-FLSH-LP-X3-SC

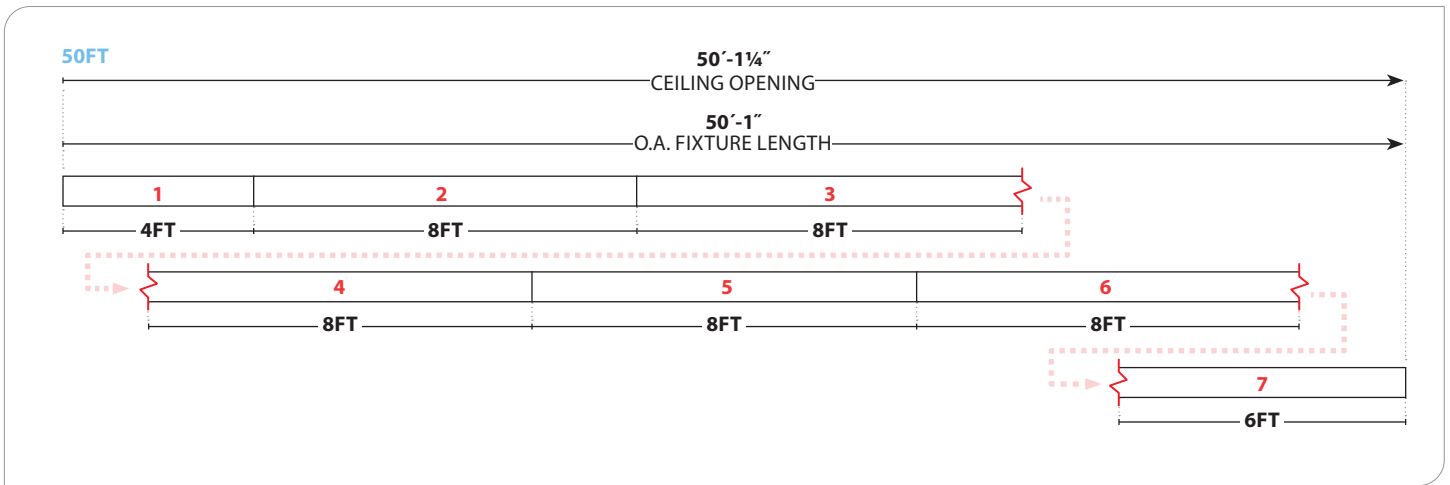

WARNING: Ground fixture in accordance with local and national electrical codes. Failure to do so may result in serious personal injury. Fixture Installations should ONLY be done by a qualified licensed electrical professional.