

Gaze | Pendant, Surface & Wall Hard Edge, Square

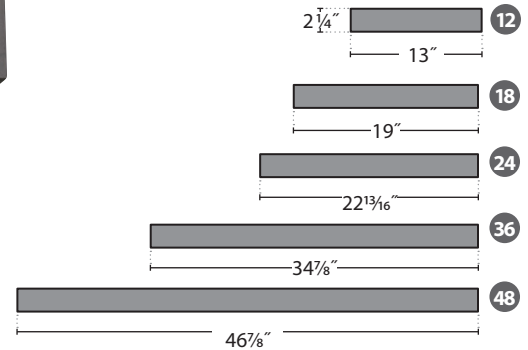

PRUDENTIAL LTG.

PRULITE.COM 213.746.0360



SPOOL



SOFT EDGE

CLICK TO LEARN MORE



SINGLE STEM (SSC)

Lumen output may vary +/- 5%
3500K used for lm/ft estimates above
4000K +2% llf, 3000K -2%, 2700K -4%
-10% llf for 90 CRI (4K, 3500K and 3K)
See LED Details PDF for more info

LUMEN OUTPUT:

D1 DIRECT		LO	MO	SO	HO
12:	lm	800	1250	1700	2300
	w	11	17	24	30
18:	lm	1550	2900	4225	5550
	w	13	24	35	48
24:	lm	2200	4050	5875	7675
	w	19	35	52	69
36:	lm	5000	9050	13100	16725
	w	43	81	121	165
48:	lm	6200	10500	17000	20700
	w	58	99	168	218

D9 INDIRECT ONLY (12" D9 NOT AVAILABLE EXCEPT SURS-LO)		LO	MO	SO	HO
18 & 24:	lm	550	1425	2200	2825
	w	7.5	18	30	41
36 & 48:	lm	1200	2400	4800	6650
	w	16	34	69	99

Gaze Hard Edge, clean and minimal form.

Gaze promises smooth, even diffusion of light, and is also available with a distinctively curved, undeniably refined Soft Edge or the elegantly soft form of Spool with a subtle .75" regress. Gaze Hard Edge has a narrow 2.25" profile, ADA compliant when wall mounted. Round and Square.

NOTE: Combine D1 and D9 IES files or see page 3 lumen chart



Declare.



Made in the USA

SERIES	SIZE	LED COLOR	OUTPUT	FIXTURE COLOR	DISTRIBUTION	CIRCUITING	VOLTAGE	MOUNTING	CEILING SYSTEMS	DRIVERS	OPTIONS
GazeSQH			—								
Square Hard Edge	12	LED27 2700K (90CRI)	LO Low	TMW Textured Matte White (Standard)	D1 Direct	SC Single Circuit	UNV (120-277)	CA48", 96" or 144" Aircraft Cable (Adjustable)	X1-ON T-Bar	ND Non-Dimming DM01 0-10v, 1% Dimming (Standard)	EMHE CA T20 Emergency Battery (800 delivered lumens) 12+18: Remote Only RPAC-EMHE often requires TWO Remote boxes, consult factory (See page 8) EMHE-RTK Remote EMHE with Remote Test Kit ETS-DR Iota ETS-DR Emergency Transfer Switch
	18	LED3 3000K	MO Medium	YGW Gloss White	D9 Direct / indirect or Semi-Direct (SURS-D9: Indirect LO Output ONLY; 12" available as SURS ONLY - MUST BE SOLO or SODA)	DC Dual Circuit (NA - 12")	347	RPM 48", 96" or 144" Round Cast Aluminum Canopy	X1-OFF T-Bar	LDE1 Lutron Hi-lume 1% EcoSystem LED (Soft fade on, fade-to-black dimming)	
	24	LED3 3000K	SO Standard	Y Premium Color				SPM 48", 96" or 144" Square Cast Aluminum Canopy	X3 Hard Ceiling	ECO 1% 0-10v, EldoLED (Logarithmic dimming std)	
	36	LED35 3500K	HO High (Static White Only)	CC Custom Color				SURF Surface Flush (D1 only)		ECDA 1% DALI, EldoLED (Logarithmic dimming std)	
	48	LED4 4000K	PROG Programmable Light Output (Specify desired lm or w/ fixture)					SURS Surface Stand-off (SURS-D9: LO Output ONLY)		SOLO 0.1% 0-10v, EldoLED (Dim-to-dark, Logarithmic dimming std)	
			LED3-90 90CRI LED35-90 90CRI LED4-90 90CRI LED5-90 90CRI	NOTE: Specify separate output Down/Up if desired eg. LO/HO (Low Down, High Up)	NOTE: All canopies are painted the same color as the fixture. Consult factory to specify different canopy color (eg. White)			PAC-R/S 96" Powered Aircraft Cable Round/Square Canopy, Direct canopy mount, X3 only (See page 8) NA with some configurations RPAC-R/S Remote Powered Aircraft Cable Round/Square Canopy (See page 8) NA with some configurations or 2 Remote Boxes may be needed SSC Center Stem (Specify length [Length refers to actual stem length not overall length]; SSC Canopy Round ONLY; NA 12" D9) See pages 4-6 for mounting dimensions			

SEE PAGE 2 FOR REMOTE BOX OPTIONS



REMOTE BOX FOR RPAC — REMOTE POWER OVER AIRCRAFT CABLES

REMOTE BOX TYPE:

DBS - SINGLE

DBD - DOUBLE

X1 T-BAR REMOTE BOXES (PLENUM ACCESS)

X3 FLANGED HARD CEILING REMOTE BOXES

X7 MUD-OVER FLANGE

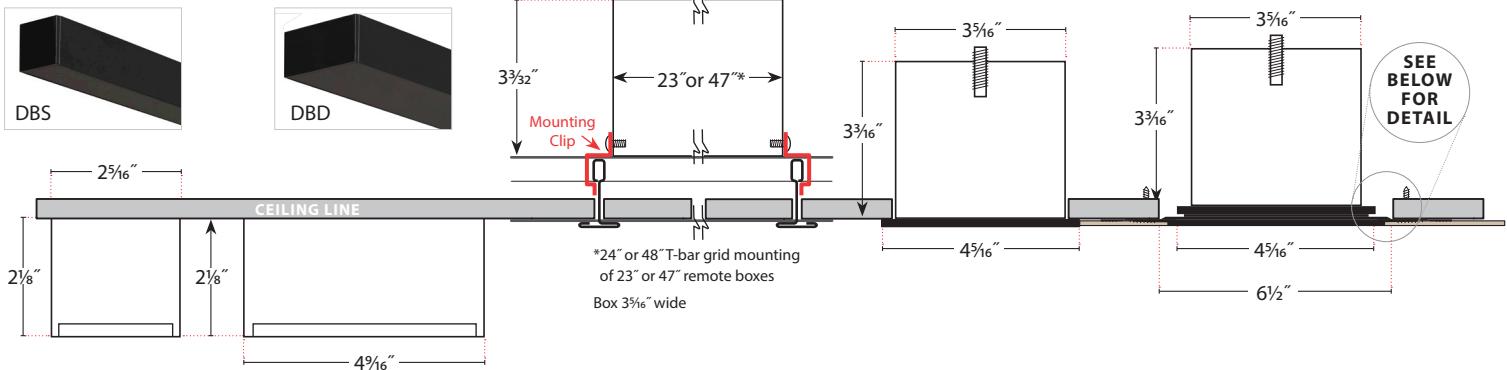

REQUIRED FOR QUOTING:

PRU WILL COMPLETE:

SERIES	REMOTE BOX TYPE	REMOTE BOX COLOR	EMERGENCY	OPTIONS	LENGTH	LINE VOLTAGE LOCATION	POWER FEED (NOT FOR X1)	MOUNTING
REMBOX						—	0	NOMT
Remote Box	DBS Deco Surface Box Single DBD Deco Surface Box Double NOTE: Double used when drivers & Emergency don't fit in Single, factory will typically determine when ordering X1 All T-Bar Ceilings X3 Hard Ceilings with Flange (Does not typically need this spec sheet filled out) X7 Hard Ceilings with Mud-over Flange	NA X1 T-bar boxes are pre-painted, DO NOT designate paint color TMW Textured Matte White (Standard) YGW Gloss White Y_ Premium Color CC Custom Color NOTE: Visible parts only	EMHE CA T20 Emergency Battery ETS-DR Iota ETS-DR Emergency Transfer Switch EMC Emergency Circuiting	OMB Overhead Mounting Bracket (X3 & X7 Only) Consult factory for Sensors installed in Remote Box	2' (Standard) 4' Custom	(DBS/DBD ONLY) LEFT: 0 1 2 RIGHT: 0 1 2 NOTE: Left is indicated by power or mount holes on cover	0	NOMT (Fixture DOES NOT mount to remote box, X1 T-Bar always NOMT)

REMOTE BOX OPTIONS

OMB (OVERHEAD MOUNTING BRACKET)

(2 Per Remote Box) Optional mounting for hard ceiling installs (X3, X7)

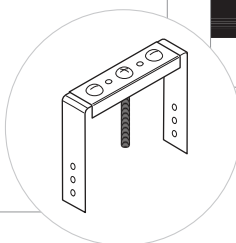
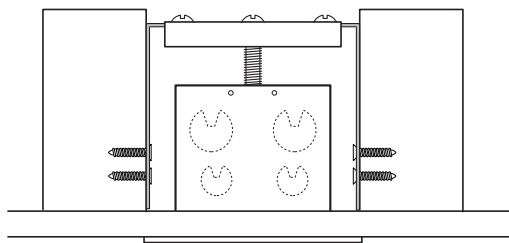

X7 DETAIL MUD-OVER FLANGE

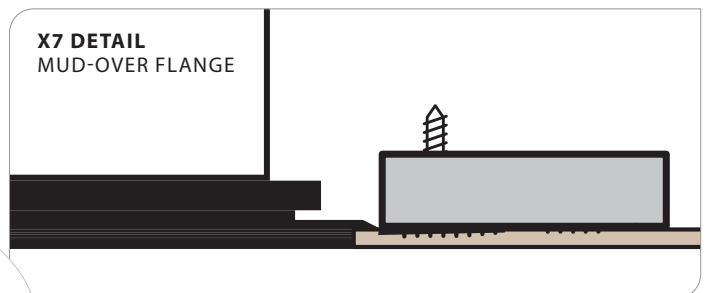

Gaze | Pendant, Surface & Wall

Hard Edge, Square



PRUDENTIAL LTG.

PRULITE.COM 213.746.0360

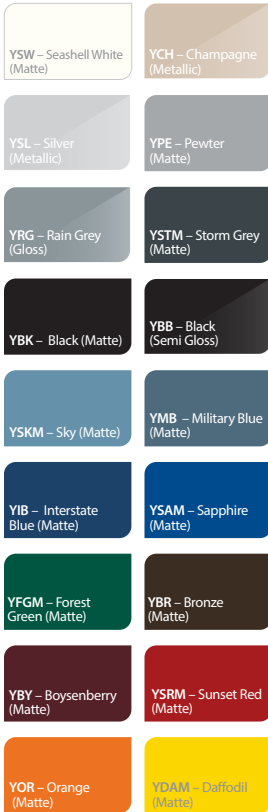

Choose from one of our Premium Colors with no set-up fee.

For paint chip samples, please email: info@prulite.com

D1 — DIRECT

GAZESQ-24-LED35-MO

4058 Delivered Lumens
35 Watts
118 lm/w

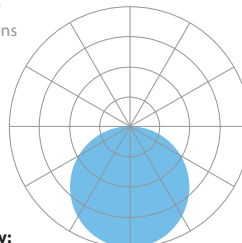

Zonal Lumen Summary:
0-90 (Down) = 100%

1430

Vertical Angle	0°	25°	45°	65°	90°
0°	1430	1430	1430	1430	1430
5°	1423	1423	1422	1423	1422
15°	1372	1372	1371	1372	1371
25°	1271	1272	1271	1271	1270
35°	1126	1127	1126	1126	1125
45°	947	947	946	946	946
55°	736	736	735	735	736
65°	389	389	390	389	389
75°	206	206	206	206	206
85°	51	51	52	52	52
90°	0	0	0	0	0

LUMEN OUTPUT:

D9 DIRECT/INDIRECT ONLY (12" D9 NOT AVAILABLE EXCEPT SURS-LO)					
		LO	MO	SO	HO
18:	lm	2100	4325	6425	8375
	w	20.5	42	65	89
24:	lm	2750	5475	8075	10500
	w	26.5	53	82	110
36:	lm	6200	11450	17900	23375
	w	59	115	190	264
48:	lm	7400	12900	21800	27350
	w	74	133	237	317

D9 — DIRECT / INDIRECT

GAZESQ-36-LED35-MO-D9

11450 Delivered Lumens
115 Watts
108 lm/w

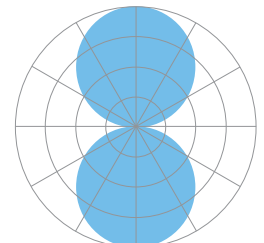

Zonal Lumen Summary:
0-90 (Down) = 79%
90-180 (Up) = 21%

3157

Vertical Angle	0°	25°	45°	65°	90°
0°	3157	3157	3157	3157	3157
5°	3142	3144	3144	3144	3142
15°	3033	3034	3033	3033	3031
25°	2819	2820	2816	2817	2814
35°	2507	2506	2502	2502	2499
45°	2114	2112	2107	2106	2105
55°	1650	1648	1644	1642	1640
65°	1137	1134	1132	1130	1129
75°	609	605	605	606	606
85°	162	161	163	164	164
90°	0	0	0	0	0
95°	25	24	23	21	21
115°	230	229	235	246	248
125°	375	377	379	392	396
135°	519	524	524	529	535
145°	653	655	656	654	656
155°	757	759	760	757	756
165°	825	829	830	828	827
175°	860	862	862	861	861
180°	865	865	865	865	865

LUMEN MAINTENANCE

- L70 — 200,000+ Hours
- L90 — 100,000+ Hours (LO, MO & SO)
- L90 — 60,000+ Hours (HO)

LED SYSTEM Drivers are field replaceable.

PROG (OPTIONAL) Programmable light output. Specify desired lumens or watts per fixture.

BINNING Standard binning (all Prudential LED boards) includes testing at the chip level and board integration to provide consistent color temperature within a 3-step MacAdams ellipse, with +/- 5% lumen output range and +/- .003 Duv.

LABELS CSA and ETL damp labeled and I.B.E.W. manufactured.

ELECTRICAL Must specify LED dimming controls. LED fixtures have constant current driver(s) with less than 20% THD when loaded to a minimum of 60%. Drivers sink a maximum of 6mA per driver. DM01 LED drivers are 0-10V dimmable and are compatible with most 0-10V wall slide dimmers and direct 0-10V analog signal dimmers. Max driver size 1.65" w x 1.25" h.

CONSTRUCTION

- Housing: Extruded aluminum, rolled and welded, >25% PC recycled, 100% recyclable.
- Lens: Edge Lit Wave Guide with Secondary Acrylic Diffuser.
- Weight: 12: 9lbs 18: 21lbs 24: 28lbs 36: 54lbs 48: 100lbs

MOUNTING Surface or suspended by aircraft cables, cast aluminum canopy or stem mounted.

WARRANTY Single-source, 5 year limited warranty covers standard components and construction.

Gaze | Pendant, Surface & Wall

Hard Edge, Square



PRUDENTIAL LTG.

PRULITE.COM 213.746.0360

MOUNTING OPTIONS

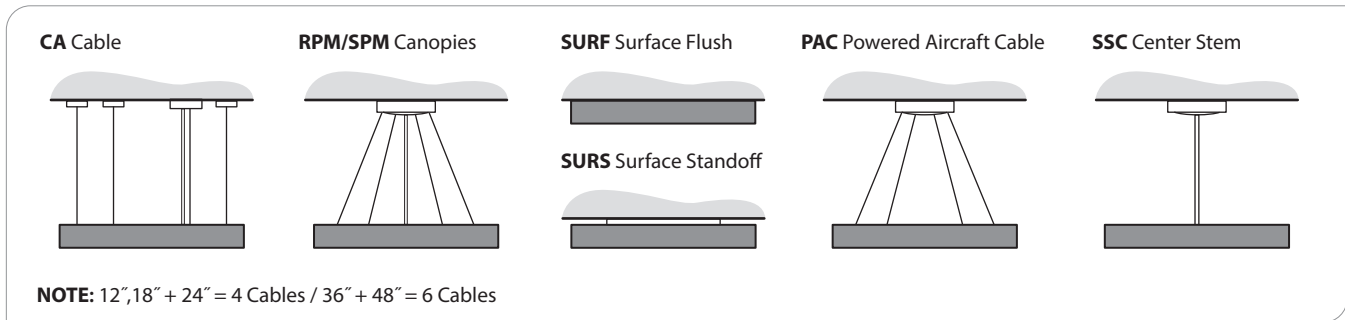

CA CABLE MOUNTING DIMENSIONS

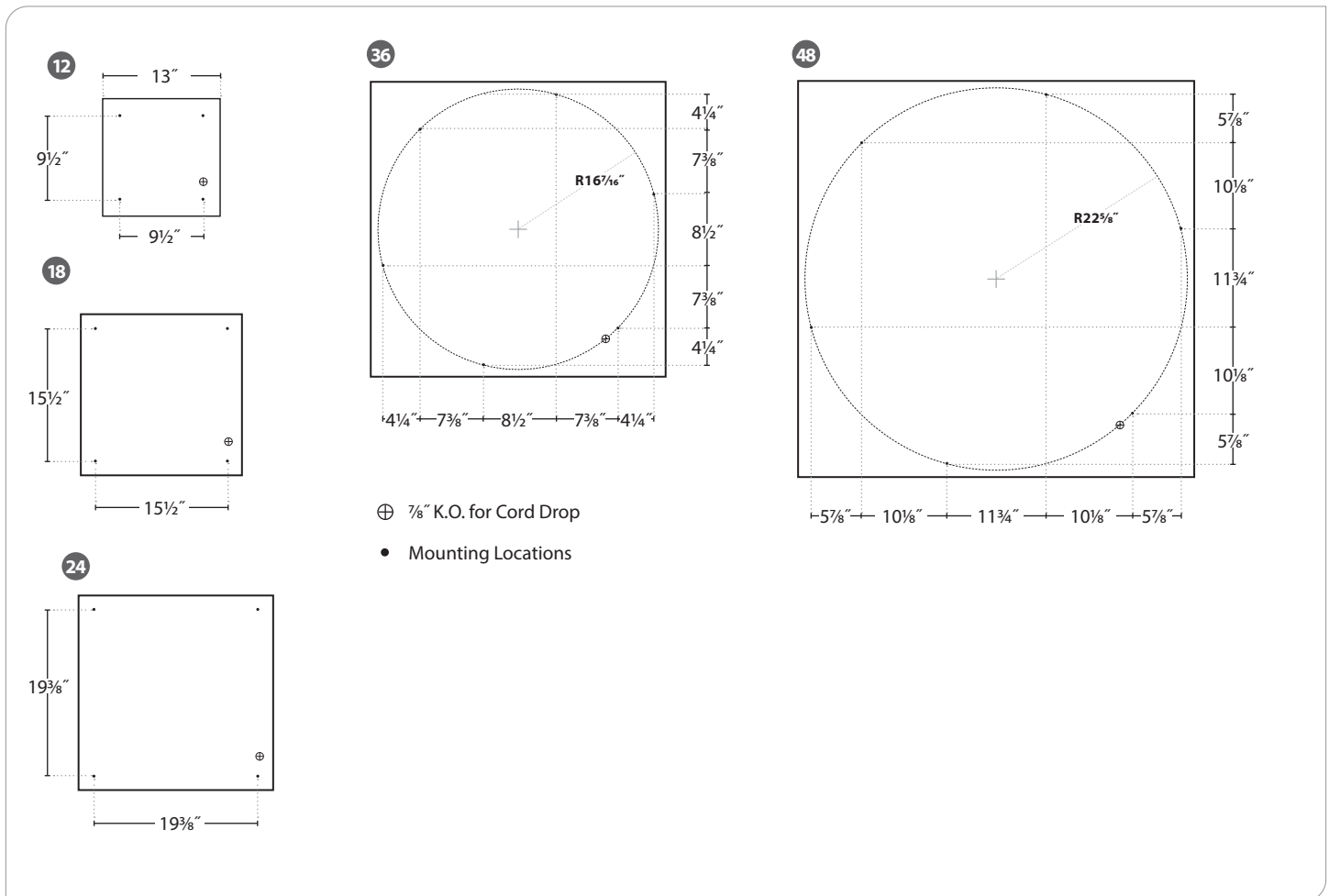



RPM/SPM CANOPY MINIMUM MOUNTING HEIGHT

HARD EDGE

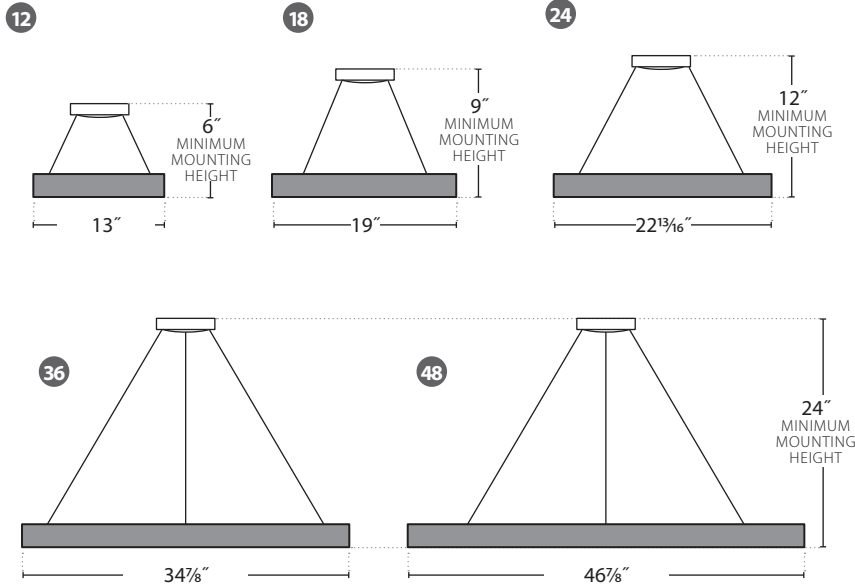

CAST ALUMINUM CANOPIES

RPM48", 96" or 144":
Round Cast Aluminum Canopy

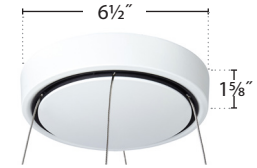

SPM48", 96" or 144":
Square Cast Aluminum Canopy

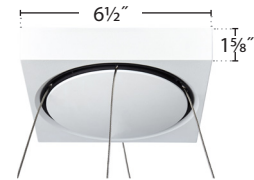

SSC IR 16-9 MINIMUM MOUNTING HEIGHT

NOTE: Minimum mounting height for California DSA IR 16-9 45° swing requirements

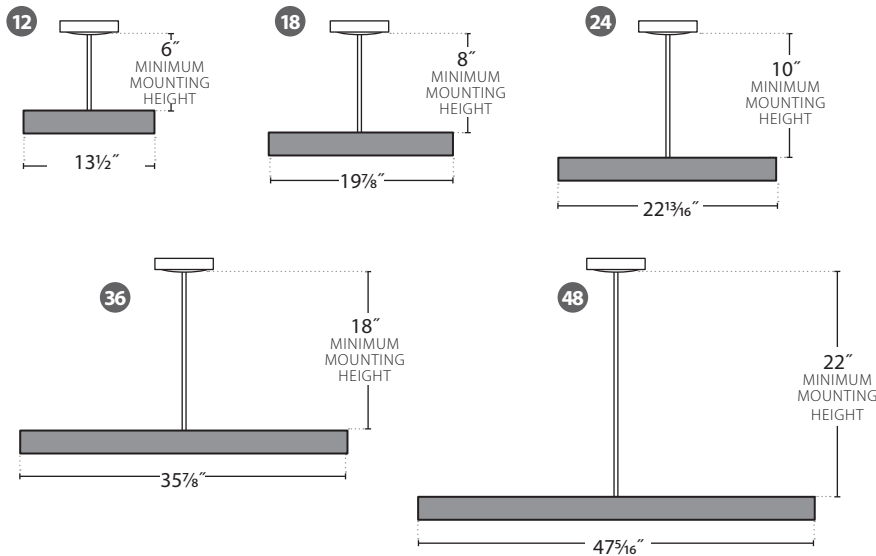

SSC CANOPY DETAIL



Allows for sloped ceilings up to 30°
SSC Canopy Round ONLY



SURFACE / SURFACE STANDOFF (CEILING OR WALL) MOUNTING DIMENSIONS

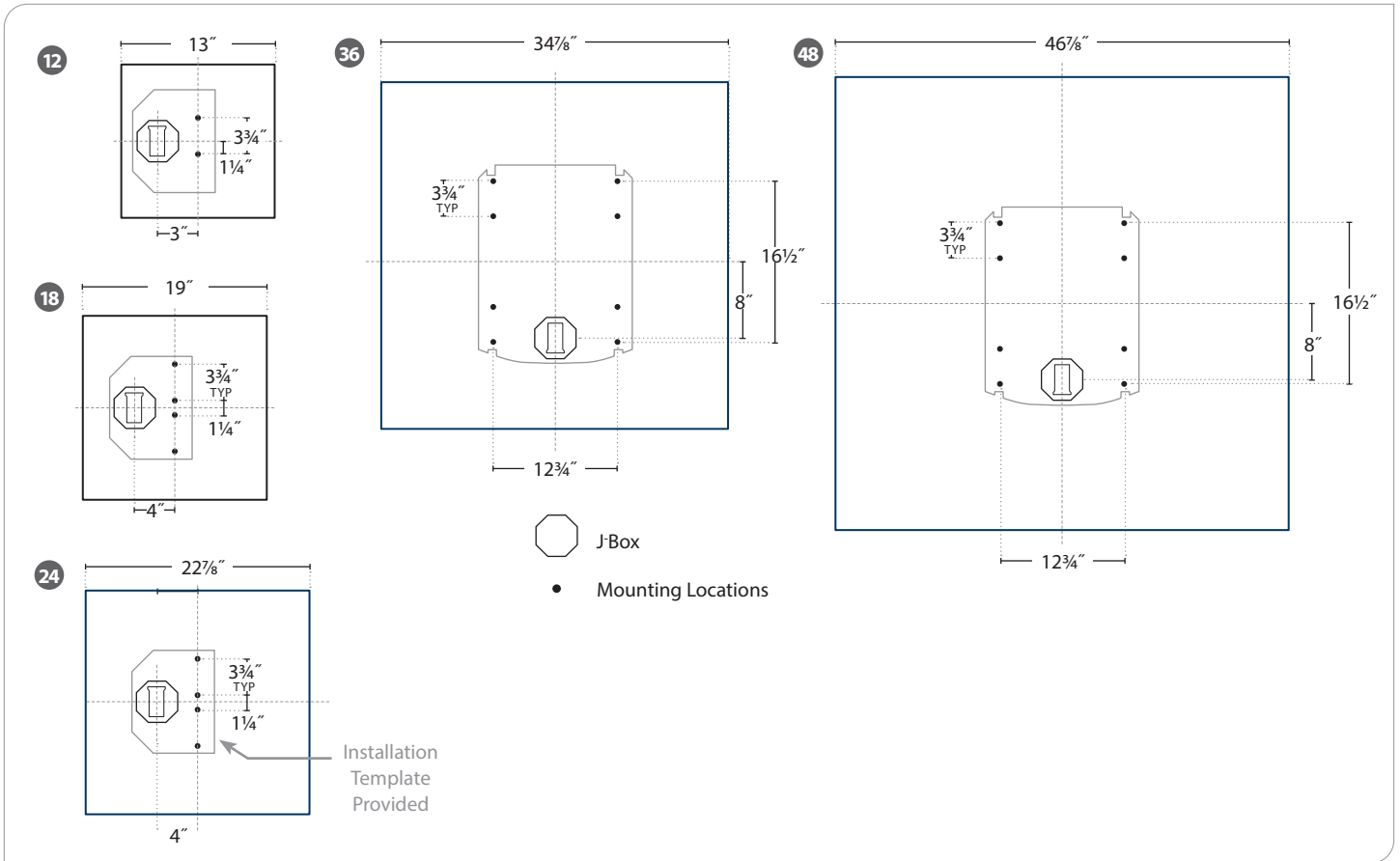

SURFACE STANDOFF DIMENSIONS

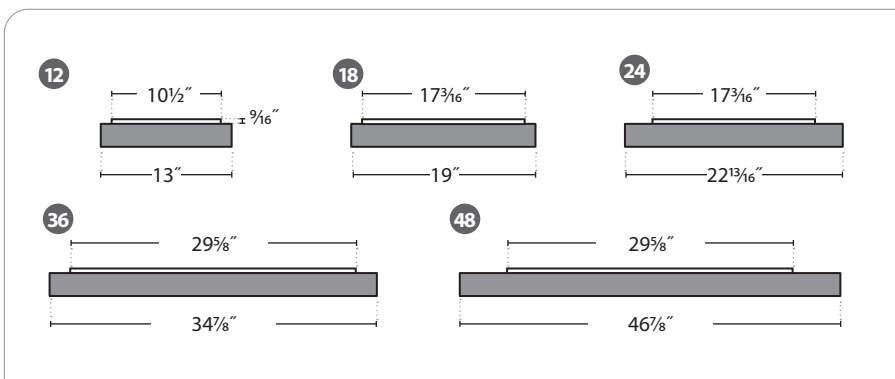

Gaze | Pendant, Surface & Wall

Hard Edge, Square



PRUDENTIAL LTG.

PRULITE.COM 213.746.0360

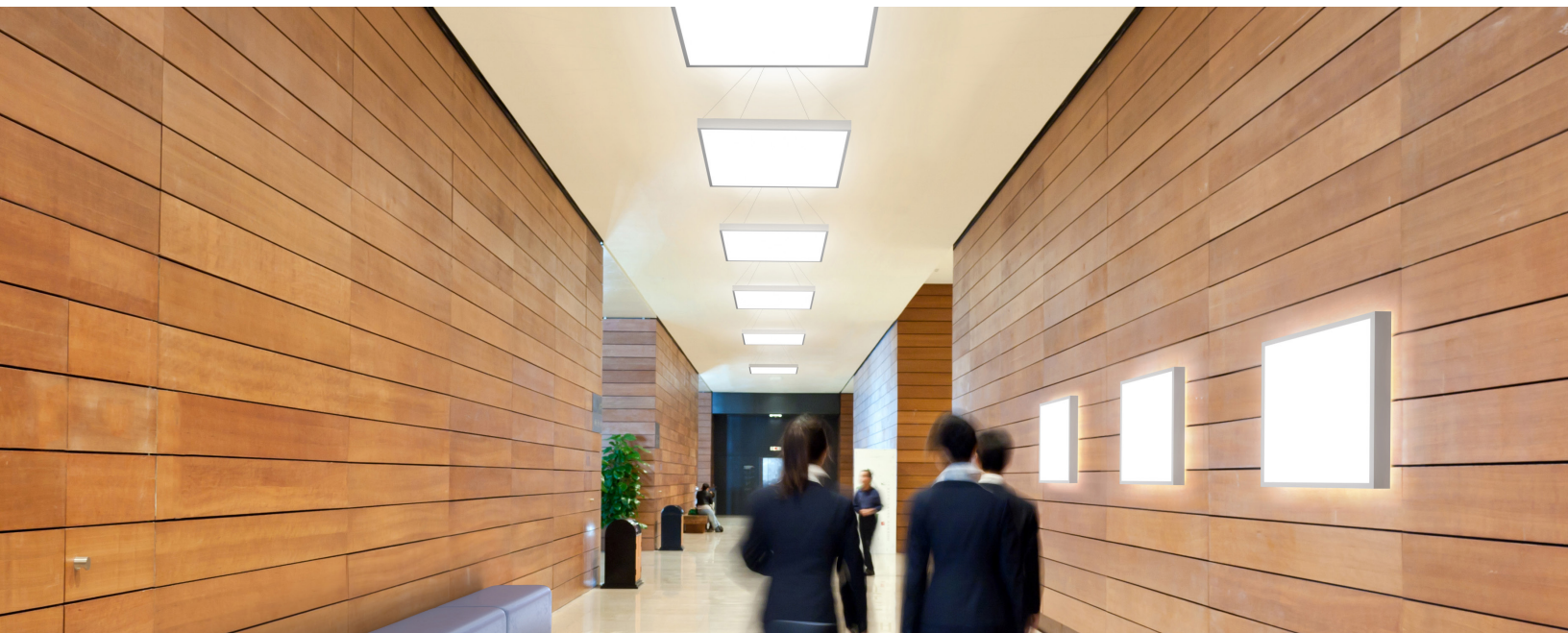

SOFT EDGE

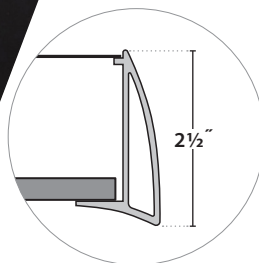

HARD EDGE

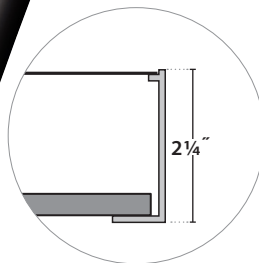

Gaze Acoustic

Gaze Acoustic fixtures offer effective noise reduction with an intentional approach to design. Alternate with coordinating light fixtures for maximum visual appeal in open spaces.

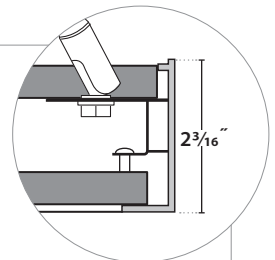

12" Available

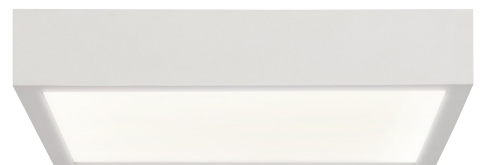

Gaze | Pendant, Surface & Wall

Hard Edge, Square



PRUDENTIAL LTG.

PRULITE.COM 213.746.0360

EMHE TEST LIGHT

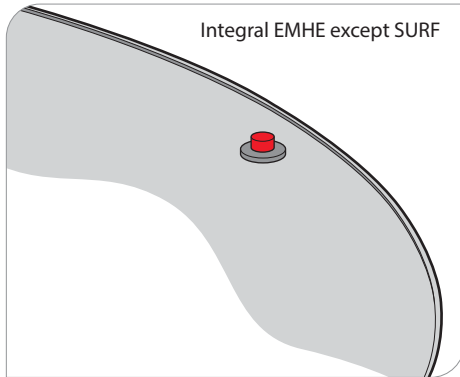

RTK: REMOTE TEST KIT

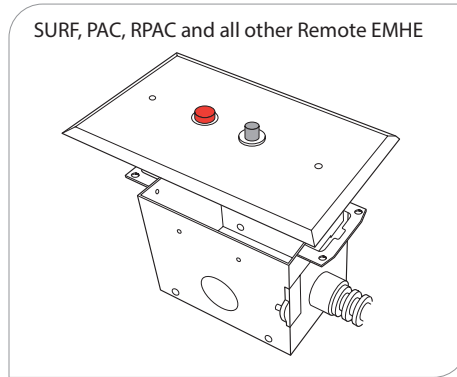

Gaze | Pendant, Surface & Wall

Hard Edge, Square

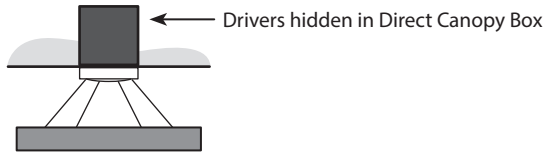

POWER CONFIGURATION: POWER OVER AIRCRAFT CABLE (NO EMHE) **MOUNTING:** PAC-R/S

REMOTE BOX TYPE: DIRECT CANOPY MOUNT **TABLE:** SHOWS WHEN AVAILABLE AND DRIVER LIMITATIONS

DIRECT	LO	LO	LO	LO	LO	MO	MO	MO	MO	MO	SO	SO	SO	SO	SO	HO	HO	HO	HO	HO	
INDIRECT	—	LO	MO	SO	HO	—	LO	MO	SO	HO	—	LO	MO	SO	HO	—	LO	MO	SO	HO	
12	✓	✓	✓	✓	✓	✓	✓	✓	✓	✓	✓	✓	✓	✓	✓	✓	✓	✓	✓	✓	✓
18	✓	✓	✓	✓	✓	✓	✓	✓	✓	✓	✓	✓	✓	✓	✓	✓	✓	✓	✓	✓	✓
24	✓	✓	✓	✓	✓	✓	✓	✓	✓	✓	✓	✓	✓	✓	✓	✓	✓	✓	✓	✓	✓
36	✓	✓	✓	✓	✓	✓	—	—	—	—	✗	✗	✗	✗	✗	✗	✗	✗	✗	✗	✗
48	✓	✓	✓	—	✗	✓	—	—	—	—	✗	✗	✗	✗	✗	✗	✗	✗	✗	✗	✗

✓ AVAILABLE
✗ NOT AVAILABLE
— AVAILABLE WITH OSRAM DRIVERS ONLY

POWER CONFIGURATION: EMERGENCY BATTERY **MOUNTING:** CA, RPM, SPM, SURFACE

REMOTE BOX TYPE: X1, X3, X7, DECO SURFACE BOX DOUBLE (DBD) **TABLE:** SHOWS WHEN REMOTE BOX IS REQUIRED AND BOX SIZE

DIRECT	LO	LO	LO	LO	LO	MO	MO	MO	MO	MO	SO	SO	SO	SO	SO	HO	HO	HO	HO	HO	
INDIRECT	—	LO	MO	SO	HO	—	LO	MO	SO	HO	—	LO	MO	SO	HO	—	LO	MO	SO	HO	
12	2'	2'	2'	2'	2'	2'	2'	2'	2'	2'	2'	2'	2'	2'	2'	2'	2'	2'	2'	2'	2'
18	2'	2'	2'	2'	2'	2'	2'	2'	2'	2'	2'	2'	2'	2'	2'	2'	2'	2'	2'	2'	2'
24	—	—	—	—	—	—	—	—	—	—	—	—	—	—	—	—	—	—	—	—	—
36	—	—	—	—	—	—	—	—	—	—	—	—	—	—	—	—	—	—	—	—	—
48	—	—	—	—	—	—	—	—	—	—	—	—	—	—	—	—	—	—	—	—	—

POWER CONFIGURATION: POWER OVER AIRCRAFT CABLE (NO EMHE) **MOUNTING:** RPAC-R/S

REMOTE BOX TYPE: X1, X3, X7, DECO SURFACE BOX DOUBLE (DBD) **TABLE:** SHOWS BOX SIZE THAT IS REQUIRED

DIRECT	LO	LO	LO	LO	LO	MO	MO	MO	MO	MO	SO	SO	SO	SO	SO	HO	HO	HO	HO	HO	
INDIRECT	—	LO	MO	SO	HO	—	LO	MO	SO	HO	—	LO	MO	SO	HO	—	LO	MO	SO	HO	
12	2'	N/A ^a	N/A ^a	N/A ^a	N/A ^a	2'	N/A ^a	N/A ^a	N/A ^a	N/A ^a	2'	N/A ^a	N/A ^a	N/A ^a	N/A ^a	2'	N/A ^a	N/A ^a	N/A ^a	N/A ^a	N/A ^a
18	2'	2'	2'	2'	2'	2'	2'	2'	2'	2'	2'	2'	2'	2'	2'	2'	2'	2'	2'	2'	2'
24	2'	2'	2'	2'	2'	2'	2'	2'	2'	2'	2'	2'	2'	2'	2'	2'	2'	2'	2'	2'	2'
36	2'	2'	2'	2'	2'	2'	2'	2'	4'	4'	2'	4'	4'	4'	4'	N/A ^b	4'	4'	4'	4'	N/A ^b
48	2'	2'	2'	2'	4'	2'	2'	4'	4'	N/A ^b	4'	4'	4'	4'	N/A ^b	N/A ^b	N/A ^b	N/A ^b	N/A ^b	N/A ^b	N/A ^b

POWER CONFIGURATION: POWER OVER AIRCRAFT CABLE WITH EMHE **MOUNTING:** RPAC-R/S

REMOTE BOX TYPE: X1, X3, X7, DECO SURFACE BOX DOUBLE (DBD) **TABLE:** SHOWS BOX SIZE THAT IS REQUIRED

DIRECT	LO	LO	LO	LO	LO	MO	MO	MO	MO	MO	SO	SO	SO	SO	SO	HO	HO	HO	HO	HO	
INDIRECT	—	LO	MO	SO	HO	—	LO	MO	SO	HO	—	LO	MO	SO	HO	—	LO	MO	SO	HO	
12	2'	N/A ^a	N/A ^a	N/A ^a	N/A ^a	2'	N/A ^a	N/A ^a	N/A ^a	N/A ^a	2'	N/A ^a	N/A ^a	N/A ^a	N/A ^a	2'	N/A ^a	N/A ^a	N/A ^a	N/A ^a	N/A ^a
18	2'	2'	2'	2'	2'	2'	2'	2'	2'	2'	2'	2'	2'	2'	2'	2'	2'	2'	2'	2'	2'
24	2'	2'	2'	2'	2'	2'	2'	2'	2'	2'	2'	2'	2'	2'	2'	2'	2'	2'	2'	2'	4'
36	2'	2'	2'	4'	4'	2'	4'	4'	4'	N/A ^c	4'	4'	4'	N/A ^c	N/A ^b	4'	N/A ^c	N/A ^c	N/A ^c	N/A ^c	N/A ^b
48	2'	2'	4'	4'	4'	4'	4'	4'	N/A ^c	N/A ^b	N/A ^c	N/A ^c	N/A ^c	N/A ^c	N/A ^b	N/A ^b	N/A ^b	N/A ^b	N/A ^b	N/A ^b	N/A ^b

N/A^a — Indirect Not Available
N/A^b — Exceeds Number of Drivers Allowed for RPAC
N/A^c — Exceeds Amperage Allowed for this Configuration

Gaze | Pendant, Surface & Wall

Hard Edge, Square



POWER CONFIGURATION: POWER OVER AIRCRAFT CABLE (NO EMHE)

MOUNTING: RPAC-R/S

REMOTE BOX TYPE: DECO SURFACE BOX SINGLE (DBS)

TABLE: SHOWS BOX SIZE THAT IS REQUIRED

DIRECT	LO	LO	LO	LO	LO	MO	MO	MO	MO	MO	SO	SO	SO	SO	SO	HO	HO	HO	HO	HO	
INDIRECT	—	LO	MO	SO	HO	—	LO	MO	SO	HO	—	LO	MO	SO	HO	—	LO	MO	SO	HO	
12	2'	N/A ^a	N/A ^a	N/A ^a	N/A ^a	2'	N/A ^a	N/A ^a	N/A ^a	N/A ^a	2'	N/A ^a	N/A ^a	N/A ^a	N/A ^a	2'	N/A ^a	N/A ^a	N/A ^a	N/A ^a	
18	2'	2'	2'	2'	2'	2'	2'	2'	2'	2'	2'	2'	2'	2'	2'	2'	2'	2'	2'	2'	4'
24	2'	2'	2'	2'	2'	2'	2'	2'	2'	2'	2'	2'	2'	2'	4'	2'	2'	4'	4'	4'	4'
36	2'	2'	2'	4'	4'	2'	4'	4'	4'	4'	4'	4'	4'	4'	N/A ^b	4'	N/A ^c	N/A ^c	N/A ^c	N/A ^c	
48	2'	2'	4'	4'	4'	4'	4'	4'	N/A ^c	N/A ^b	4'	N/A ^c	N/A ^c	N/A ^c	N/A ^b	N/A ^b	N/A ^b	N/A ^b	N/A ^b	N/A ^b	

POWER CONFIGURATION: POWER OVER AIRCRAFT CABLE (NO EMHE)

MOUNTING: RPAC-R/S

REMOTE BOX TYPE: DECO SURFACE BOX SINGLE (DBS)

TABLE: SHOWS BOX SIZE THAT IS REQUIRED

DIRECT	LO	LO	LO	LO	LO	MO	MO	MO	MO	MO	SO	SO	SO	SO	SO	HO	HO	HO	HO	HO	
INDIRECT	—	LO	MO	SO	HO	—	LO	MO	SO	HO	—	LO	MO	SO	HO	—	LO	MO	SO	HO	
12	4'	N/A ^a	N/A ^a	N/A ^a	N/A ^a	4'	N/A ^a	N/A ^a	N/A ^a	N/A ^a	4'	N/A ^a	N/A ^a	N/A ^a	N/A ^a	4'	N/A ^a	N/A ^a	N/A ^a	N/A ^a	
18	4'	4'	4'	4'	4'	4'	4'	4'	4'	4'	4'	4'	4'	4'	4'	4'	4'	4'	4'	4'	N/A
24	4'	4'	4'	4'	4'	4'	4'	4'	4'	4'	4'	4'	4'	4'	N/A ^c	4'	4'	N/A ^c	N/A ^c	N/A ^c	
36	4'	4'	4'	N/A ^c	N/A ^c	4'	N/A ^c	N/A ^c	N/A ^c	N/A ^c	N/A ^c	N/A ^c	N/A ^c	N/A ^c	N/A ^b	N/A	N/A	N/A	N/A	N/A ^b	
48	4'	4'	N/A ^c	N/A ^c	N/A ^c	N/A ^c	N/A ^c	N/A ^c	N/A ^c	N/A ^c	N/A ^c	N/A ^c	N/A ^c	N/A ^c	N/A ^b	N/A ^b	N/A ^b	N/A ^b	N/A ^b	N/A ^b	

N/A^a — Indirect Not Available **N/A^b** — Exceeds Number of Drivers Allowed for RPAC **N/A^c** — Exceeds Amperage Allowed for this Configuration



PACS AND RPACR CROSS SECTIONS

DIRECT CANOPY MOUNT (PAC) Canopy Driver Box — Driver access behind canopy

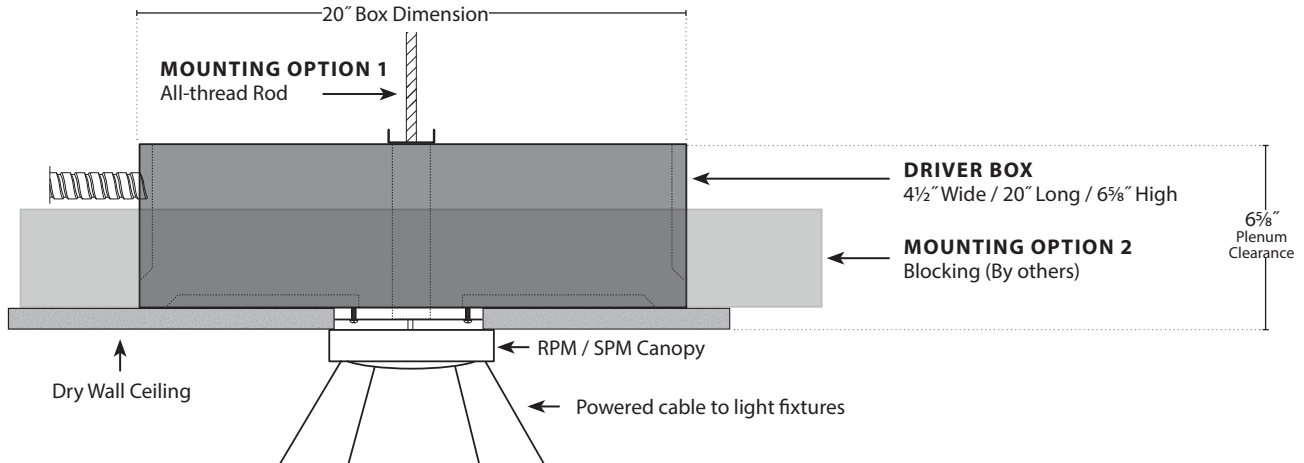

REMOTE (RPAC - X7, X3, X1): Remote Driver Box — Remote access required

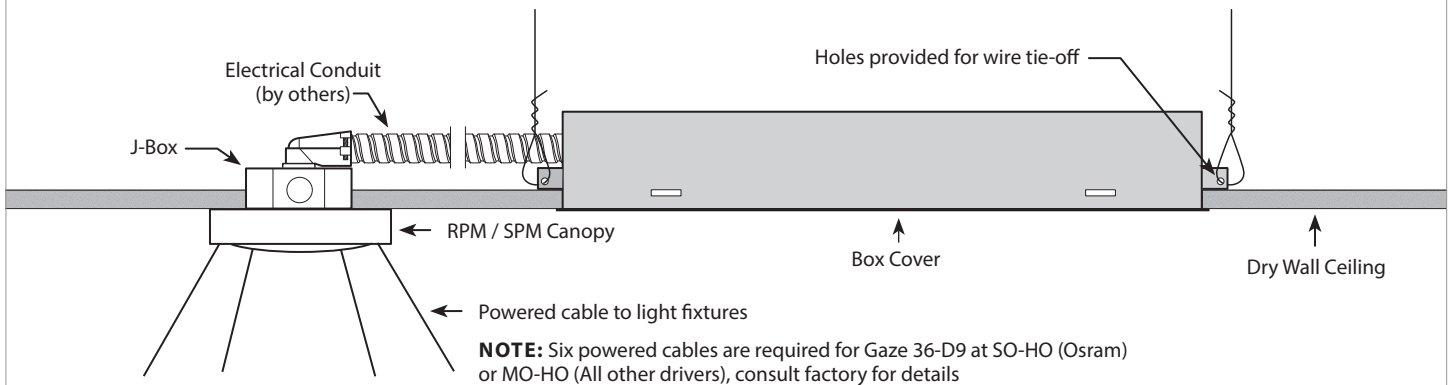

DECO BOX DETAIL (DBS OR DBD)

SURFACE MOUNT J-BOX WITH SIDE FEED:

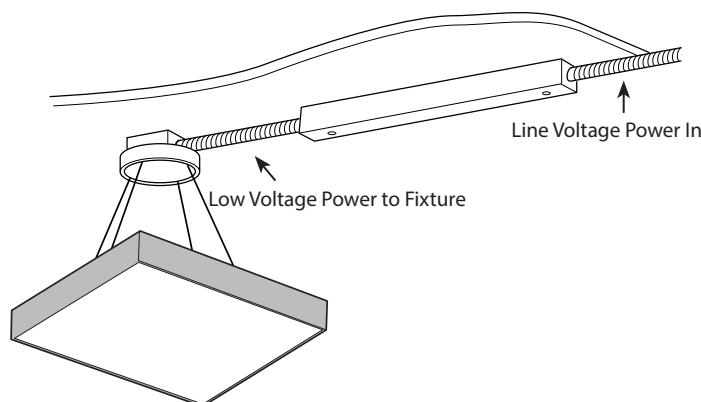

RECESSED J-BOX WITH TOP FEED:

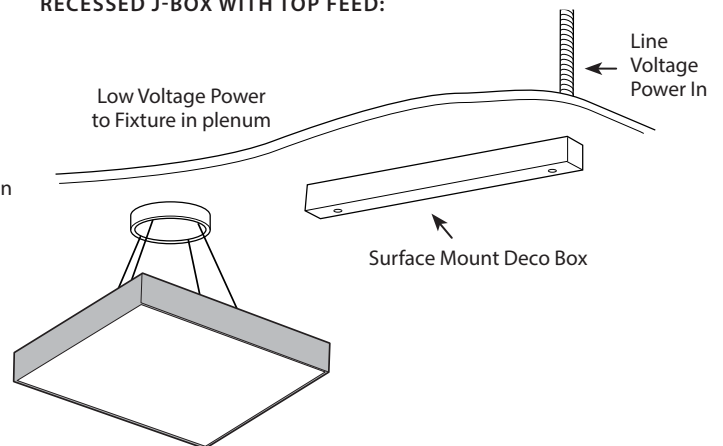

Gaze | Pendant, Surface & Wall

Hard Edge, Square



PRUDENTIAL LTG.

PRULITE.COM 213.746.0360

LM79 & TM30 DATA:

	MEASURED CCT	MEASURED LUMENS	CRI	R9	DuV	SPD	TM30 — COLOR VECTOR	TM30 — COLOR DISTORTION
LED27	2680	80%	93	58	0.001		 89 Rf	 97 Rg
LED3	3042	95%	82	6	0.001		 81 Rf	 92 Rg
LED3-90	3016	85%	93	61	0.000		 88 Rf	 96 Rg
LED35	3482	100%	82	3	0.002		 81 Rf	 92 Rg
LED35-90	3417	85%	93	67	0.000		 88 Rf	 96 Rg
LED4	3952	102%	82	4	0.003		 81 Rf	 92 Rg
LED4-90	3882	85%	92	67	0.003		 87 Rf	 96 Rg
LED5-90	4889	85%	94	84	0.002		 86 Rf	 95 Rg