

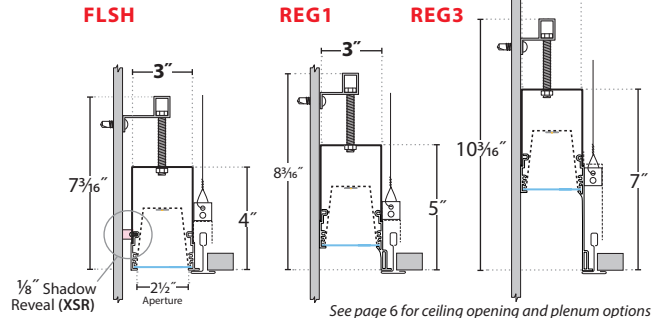

T-BAR — X1, X1M, X1T, X2, X6:



	BPRO3-PER-FLSH-LED35-MO-SAL
	2300 Delivered Lumens
	23 Watts
	101 Lm/W

Lumen output may vary +/- 5%
Light Loss Factor (LLF) for CCTs other than 3500K:
 4000K +2%, 3000K -5%, 2700K -20%
 90 CRI -15% (3K, 3500K, 4K & 5K ADC -2% LLF
 Louver LLF 30% White, 50% Silver, 70% Black

FLSH:	LO	MO	SO	HO
SAL Lm/Ft	435	640	885	1115
PFL Lm/Ft	475	700	975	1225
NGZ Lm/Ft	525	775	1075	1200
MGZ Lm/Ft	475	700	975	1225
WGZ Lm/Ft	525	775	1075	1200
LGP Lm/Ft	475	700	975	—
W/Ft	3.8	5.6	7.8	10.5

LUMEN CHART AT 3500K-80 CRI
 SEE PAGE 5 FOR REGRESS

TUNABLE WHITE

Tu Hue
 Amber Hue
 Blu Hue
 Chroma Hue



SERIES	LENS POS.	LED COLOR	OUT-PUT	NOMINAL LENGTH	TRIM COLOR	LOUVER COLOR	DISTRIBUTION	MOUNTING	CIRCUITING	VOLTAGE	CEILING SYSTEMS	DRIVERS	OPTIONS, CONTROL SENSORS & CORNERS
BPRO3-PER									SC				
BionicPro 3" Perimeter	FLSH Flush Lens LVR Louver Flush REG.5 1/2" Regress LVR1 Louver 1/2" Regress REG1 1" Regress LVR3* Louver 2 1/2" Regress REG3* 3" Regress * NA PFL	LED27 2700K (90CRI) LED3 3000K LED35 3500K LED4 4000K LED3-90 3000K (90CRI) LED35-90 3500K (90CRI) LED4-90 4000K (90CRI) LED5-90 5000K (90CRI) PRUHUES: (BIOS) STATIC: BLU3S BLU35S BLU4S DYNAMIC: BLU3D* BLU35D* BLU4D* *Dynamic BIOS, SkyBlue spike can be dimmed, CCT warms slightly TU TuHue 2700-6500K TunableWhite TU2** TuHue 2200-5000K TunableWhite AMB** Amber-Hue Warm Dim 2200K-5000K ** NA-HO CHR Chroma-Hue RGBW (DMX at HO only)	LO Low MO Medium SO Standard HO High PROG Programmable Light Output (Specify desired lm/ft or w/ft)	2' 3' 4' 5' 6' 7' 8' R (Row Length) NOTE: Individual fixtures are NOT intended for row mounting. Requires field-cut filler fixture at end of row	TMW Textured Matte White (Standard) YGW Gloss White Y Premium Color CC Custom Color LUXE METAL-LICS: YBZ Bronze YCP Copper Penny YGN Gold Nuggetd Nugget	SKIP COLUMN IF LOUVER IS NOT NEEDED SAL Satin Lens NGZ Narrow Wall Graze MGZ Medium Wall Graze WGZ Wide Wall Graze LGP Low Glare Prismatic (NA HO) PFL Perimeter Room Fill (NA Reg3 / Lvr3) LUXE METAL-LICS: YBZ Bronze YCP Copper Penny YGN Gold Nuggetd Nugget	LP Light Pocket WTW Wall to Wall NOTE: Requires filler fixture at end of row. All non nominal lengths require FIELD CUTTABLE filler fixture at end of row	SC Single Circuit	UNV (120-277) 120 277 347 (Emergency battery requires a Step Down transformer and remote box)	X1 1 5/16" T-Bar X1M 1 5/16" T-Bar X1T 1 5/16" T-Bar X2 Regular X2 Dimensional T-Bar X3 Hard Ceiling (Flange Trim) X6 Slot Grid X7 Mud-Over Flange X9 Finished Extruded Side (Grid Ceiling) X11 Finished Extruded Side (Ceilings needing nominal lengths)	ND Non-Dimming DM01 0-10v, 1% Dimming (Standard) LDE1 Hi-lume 1% EcoSystem LED (Soft fade on, fade-to-black dimming) ECO 1% 0-10v, EldoLED (Logarithmic dimming std) ECDA 1% DALI, EldoLED (Logarithmic dimming std) nLight-Air Acuity nLight Drivers (ECDA driver ONLY) nLight-Wired Acuity nLight Drivers (ECO driver ONLY) SOLO 0.1% 0-10v, EldoLED (Dim-to-dark, Logarithmic dimming std) SODA 0.1% DALI, EldoLED (Dim-to-dark, Logarithmic dimming std) STEP Signify Advance Step Dimming 2WIRE ELV/ Forward/Reverse Phase Driver PRUHUES: E10V 2 Channel Color Control EDALI 2 Channel Color Control EDMX ChromaHue or Static White NOTE: May require Insulation Detector (ID)	EMHE / EMHE-RTK+ CA T20 Emergency Battery / Remote Test Kit (900 Delivered lumens, CA Title 20 compliant, 2'-3" remote) ETS-DR / ETS-RTK+ Iota ETS-DR Emergency Transfer Switch / Remote Test Kit ± 2" + 3"; Non-IC rated, NA with UNV voltage, Adds 1 1/2" height, EMC Emergency Circuiting FTR End of row feathering to soften Wall Grazing or PFL effect on Perpendicular Wall (WTW) (NA HO or LGP) CP Chicago Plenum IDSM Insulation Detector Side Mount (for plenums <6" where fixtures are non-IC rated) XSR 1/8" Shadow Reveal SENSORS: (NA w/EDMX) 205 WattStopper PIR Occupancy 205-ON/OFF 205-STEP: Dim to 50% 205-DM: Dim to 1% (NA with DALI) ATHENA Lutron RF (Dim-to-Off Standard) LVOC** Lutron Vive (Occ & RF) LVRF** Lutron Vive (RF Only) ** Requires Lutron driver NXSMP Hubbell (Occ) rE57 Daylight+ (PIR Acoustic) (Occ (nLight-Air) Part Number: rE57-PDT-180D-G2 nE57 Daylight+(PIR Acoustic) (Occ (nLight-Wired) Part Number: nE5-PDT7-ADCX NOTE: Sensors NA with REG3, tile mount (by others) CORNERS: C2I-60 Lit 60° Inside C2O-60 Lit 60° Outside C2I-90 Lit 90° Inside C2O-90 Lit 90° Outside C2I-120 Lit 120° Inside C2O-120 Lit 120° Outside C3T Lit 90° 3-Way: T 90° LOUVERS AVAILABLE (CONSULT FACTORY FOR OTHER ANGLES) DWNLT Downlights	

BionicPro3™ | Perimeter Downlights



PRUDENTIAL LTG.

PRULITE.COM 213.746.0360



Two Rows (BPRO4 & 5)

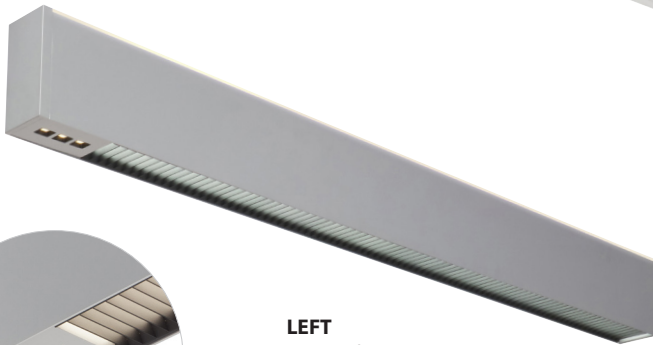

LEFT
(Start) Placement
(BPRO2 Linear shown with Louver)



One Row (BPRO2 & 3)

MID
Middle of Row Placement
(BPRO4 Recessed shown with Flush Lens)



INDIRECT ONLY
(BPRO2 Linear shown)

		NRW 20°	MED 35°	WDE 55°
1 ROW	Lm	445	425	350
	W	9	9	9
2 ROWS	Lm	500	465	425
	W	8.7	8.7	8.7

NRW 20°				MED 35°				WDE 55°			
DISTANCE	FOOTCANDLES		BEAM	DISTANCE	FOOTCANDLES		BEAM	DISTANCE	FOOTCANDLES		BEAM
	1 ROW	2 ROWS			1 ROW	2 ROWS			1 ROW	2 ROWS	
3'	251	281.5	12.7"	3'	138	144	22.8"	3'	80	67	37.5"
4'	104.7	116.7	17.0"	4'	67.3	70	30.3"	4'	40	35.7	50.0"
5'	82.3	91.7	21.1"	5'	47	49.2	37.8"	5'	27	23.7	62.5"
6'	52.9	58.5	25.4"	6'	31.5	32.7	45.4"	6'	18	16.1	75.0"
7'	29.5	32.7	29.6"	7'	17.6	18.4	53.0"	7'	10	9.1	87.5"
8'	27.6	30.53	33.8"	8'	16.05	16.9	60.5"	8'	9	8.15	100.0"
9'	25.7	28.36	38.1"	9'	14.5	15.4	68"	9'	9	7.2	112.4"

SE-RIES	QUANTITY	LOCATION	CCT	DISTRIBU-TION	COLOR	VOLTAGE	DRIVERS
DWN-LT							
Down-light	SPECIFY DOWN-LIGHT QUANTITY PER FIX-TURE/ROW Maximum One (1) Downlight Every 4' 16' Row = 4 Downlights 30' Row = 7 Downlights	MID One Downlight in Middle of Fixture LT One Downlight on Left (Start) RT One Downlight on Right (End) LT-RT Two Downlights on Ends LT-MID Two Downlights on Left and Middle MID-RT Two Downlights on Middle and End MOD Downlight Location(s) per Specs	LED3-90 3000K-90CRI (Standard) LED35-90 3500K-90CRI LED4-90 4000K-90CRI NOTES: - NA 2700K, 5000K - Only 1 Output Offered	NRW Nar-row 20° Beam MED Me-dium 35° Beam WDE Wide 55° Beam	TMW Textured Matte White (Standard) YGW Gloss White Y_ Premium Color CC Custom Color LUXE METALLICS: YBZ Bronze YCP Copper Penny YGN Gold Nuggetd Nugget	UNV (120-277) 347	DM01 0-10v, 1% Dimming (Standard) LDE1 Hi-lume 1% EcoSystem LED (Soft fade on, fade-to-black dimming) ECO 1% 0-10v, EldoLED (Logarithmic dimming std) ECDA 1% DALI, EldoLED (Logarithmic dimming std) SOLO 0.1% 0-10v, EldoLED (Dim-to-dark, Logarithmic dimming std) SODA 0.1% DALI, EldoLED (Dim-to-dark, Logarithmic dimming std)

Prudential Ltg. reserves the right to change design specifications or materials without notice. Please visit prulite.com for most current data.
© 2026 All rights reserved—All products manufactured at: Prudential Ltg. 1774 E. 21st Street, Los Angeles, CA 90058



LUMEN MAINTENANCE

- L70** — 200,000+ Hours
- L90** — 100,000+ Hours (LO, MO & SO)
- L90** — 60,000+ Hours (HO)

LED SYSTEM LED modules and drivers are field replaceable.

PROG (OPTIONAL) Programmable light output. Specify desired lumens or watts per linear foot.

BINNING Standard binning (all Prudential LED boards) includes testing at the chip level and board integration to provide consistent color temperature within a 3-step MacAdams ellipse, with +/- 5% lumen output range and +/- .004 Duv.

LABELS ETL damp labeled and I.B.E.W. manufactured.

WARRANTY Single-source, 5 year limited warranty covers standard components and construction.

ELECTRICAL Must specify LED dimming controls. LED fixtures have constant current driver(s) with less than 20% THD when loaded to a minimum of 60%. Drivers sink a maximum of 6mA per driver. DM01 LED drivers are 0-10V dimmable and are compatible with most 0-10V wall slide dimmers and direct 0-10V analog signal dimmers. Max driver size 1.65" w x 1.25" h.

CONSTRUCTION

Housing Extruded aluminum trim and side wall >25% PC recycled, 100% recyclable.

20-gauge steel top housing >20% PC recycled, 100% recyclable.

Die-Cast endcaps (LP), Formed steel endcaps (WTW)

Lens Seamless lens up to 200'. Consult factory for longer lengths. Polymer, 100% recyclable.

Weight 4 lbs / ft.

MOUNTING Recessed into drywall or t-bar ceilings or walls.

INSULATION DETECTOR (ID) FOR NON-IC RATED FIXTURES

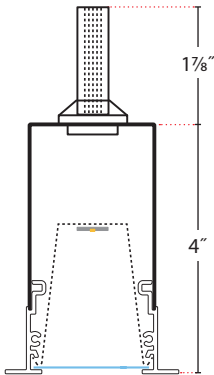

Insulation Detector (ID) REQUIRED for non IC-rated fixtures
Non IC-rated = **NO INSULATION ALLOWED**

ID REQUIRED for:

Osram	ELDO	Lutron & Signify	EMHE	Custom Length*	EMHE + Custom Length
—	ALL	—	SO-HO	SO-HO	ALL
			ELDO ALL	ELDO ALL	

* Custom length = field adjustable, not 1' increments

Request **Insulation Detector Side Mount (IDSM)** if plenum less than 6"

FINISH COLORS

STANDARD:

TMW — Textured Matte White

YGW — Gloss White

PREMIUM:

YSW — Seashell White (Matte)

YPE — Pewter (Matte)

YRG — Rain Grey (Gloss)

YSTM — Storm Grey (Matte)

YBK — Black (Matte)

YBB — Black (Semi Gloss)

YSKM — Sky (Matte)

YMB — Military Blue (Matte)

YSAM — Sapphire (Matte)

YIB — Interstate Blue (Matte)

YBR — Bronze (Matte)

YSRM — Sunset Red (Matte)

YOR — Orange (Matte)

YDAM — Daffodil (Matte)

YFGM — Forest Green (Matte)

YSL — Silver (Metallic)

LUXE METALLICS:

YCP — Copper Penny (Metallic)

YBZ — Bronze (Metallic)

YGN — Gold Nugget (Metallic)

Choose from one of our Premium Colors with no set-up fee. For paint chip samples, please email: info@prulite.com



FLSH:

SATIN LENS — DISTRIBUTION

Medium Output:

BPRO3-PER-FLSH-LED35-MO-SAL

- 2300 Delivered Lumens
- 23 Watts
- 101 lm/w
- 3500 CCT
- 1.18 Spacing Criteria

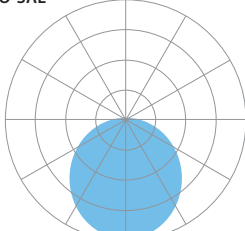

Zonal Lumen Summary:
0-90 = 100%

850

Vertical Angle	0°	25°	45°	65°	90°
0°	850	850	850	850	850
5°	841	842	840	846	852
15°	795	797	798	808	817
25°	715	718	723	739	750
35°	616	618	625	644	657
45°	504	504	513	531	547
55°	382	384	392	407	424
65°	257	259	267	281	295
75°	134	135	143	155	168
85°	21	23	28	38	48
90°	0	0	0	0	0

LOW GLARE PRISMATIC

STANDARD OUTPUT:

BPRO2-LED35-SO-LGP

- 3695 Delivered Lumens
- 32 Watts
- 117 lm/w
- 3500 CCT

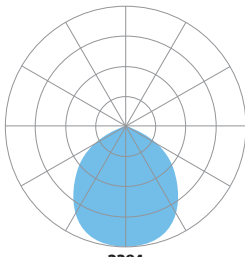

Zonal Lumen Summary:
0-90 = 100%

2384

Vertical Angle	0°	25°	45°	65°	90°
0°	2384	2384	2384	2384	2384
5°	2336	2337	2339	2364	2385
15°	1834	1894	2042	2208	2280
25°	1165	1239	1494	1886	2068
35°	774	812	990	1440	1757
45°	547	568	662	982	1366
55°	357	368	418	601	924
65°	193	200	222	300	446
75°	88	92	99	124	162
85°	27	27	27	29	33
90°	0	0	0	0	0

MEDIUM WALL GRAZER

LOW OUTPUT:

BPRO3-FLSH-LED35-LO-4-MGZ-DM01

- 1930 Delivered Lumens
- 15 Watts
- 128 lm/w
- 4000 CCT
- 18° FWHM

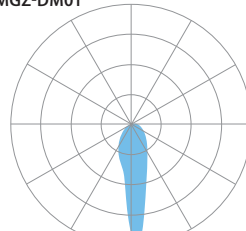

Zonal Lumen Summary:
0-90 = 100%

2086

Vertical Angle	0°	25°	45°	65°	90°
90°	0	0	0	0	0
85°	24	22	21	23	26
75°	81	76	75	84	90
65°	138	133	140	170	183
55°	200	199	222	304	369
45°	276	281	320	474	696
35°	373	384	437	680	1139
25°	498	515	600	994	1600
15°	729	765	968	1542	1929
5°	1756	1771	1925	2097	2076
0°	2086	2086	2086	2086	2086
5°	1384	1476	1615	1858	2076
15°	642	677	806	1229	1929
25°	475	491	550	813	1600
35°	363	379	418	585	1139
45°	263	276	315	426	696
55°	187	194	219	284	369
65°	132	129	140	165	183
75°	82	78	75	83	90
85°	23	25	22	24	26
90°	0	0	0	0	0
Vertical Angle	180°	202.5°	225°	247.5°	270°

PERIMETER FILL

LOW OUTPUT:

BPRO3-FLSH-LED35-LO-4-PFL

- 1901 Delivered Lumens
- 15 Watts
- 126 lm/w
- 3500 CCT

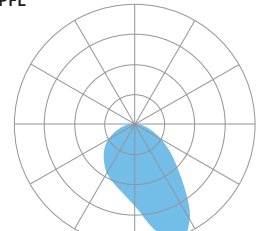

Zonal Lumen Summary:
0-90 = 100%

1059

Vertical Angle	0°	25°	45°	65°	90°
90°	0	0	0	0	0
85°	22	22	27	29	30
75°	75	80	103	104	95
65°	155	169	226	211	162
55°	284	312	423	374	249
45°	494	546	678	555	359
35°	827	868	885	691	475
25°	1059	1039	940	767	584
15°	992	971	893	788	669
5°	818	815	786	754	715
0°	720	720	720	720	720
5°	626	635	647	677	715
15°	523	528	540	582	669
25°	466	470	474	496	584
35°	408	409	411	417	475
45°	351	348	341	335	359
55°	285	281	263	244	249
65°	210	203	180	159	162
75°	121	120	101	90	95
85°	33	35	30	28	30
90°	0	0	0	0	0
Vertical Angle	180°	202.5°	225°	247.5°	270°

Consult factory for Regress and Louver IES:
marketing@prulite.com



REG.5:

SATIN LENS

STANDARD OUTPUT:

BPRO3-PER-REG.5-LED35-SO-SAL

3342 Delivered Lumens
31 Watts
109 Lm/W
3500 CCT

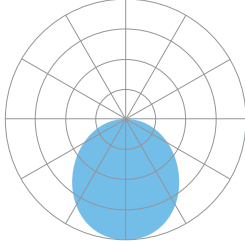

REG.1:

STANDARD OUTPUT:

BPRO3-PER-REG1-LED35-SO-4-SAL

3161 Delivered Lumens
31 Watts
103 Lm/W
3500 CCT

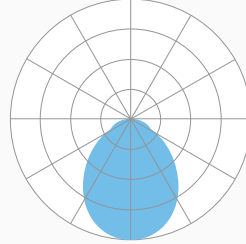

REG.3:

STANDARD OUTPUT:

BPRO3-PER-REG3-LED35-SO-4-SAL

2581 Delivered Lumens
31 Watts
83 Lm/W
3500 CCT

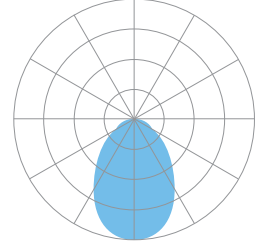

MEDIUM WALL GRAZER

STANDARD OUTPUT:

BPRO3-PER-REG.5-LED35-SO-4-MGZ

3705 Delivered Lumens
31 Watts
120 Lm/W
3500 CCT
16" FWHM

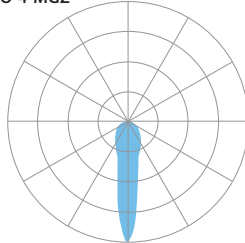

STANDARD OUTPUT:

BPRO3-PER-REG1-LED35-SO-4-MGZ

3647 Delivered Lumens
31 Watts
119 Lm/W
3500 CCT
18" FWHM

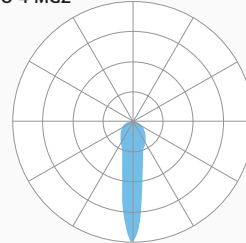

STANDARD OUTPUT:

BPRO3-PER-REG3-LED35-SO-4-MGZ

3143 Delivered Lumens
31 Watts
102 Lm/W
3500 CCT
18" FWHM

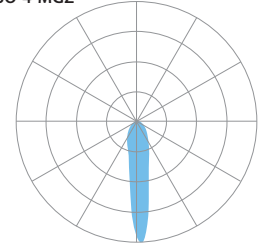

PERIMETER FILL

STANDARD OUTPUT:

BPRO3-PER-REG.5-LED35-SO-4-PFL

3591 Delivered Lumens
33 Watts
117 Lm/W
3500 CCT

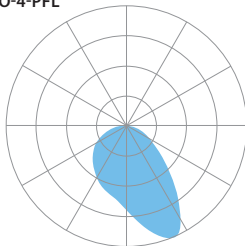

STANDARD OUTPUT:

BPRO3-PER-REG1-LED35-SO-4-PFL

3488 Delivered Lumens
32 Watts
113 Lm/W
3500 CCT

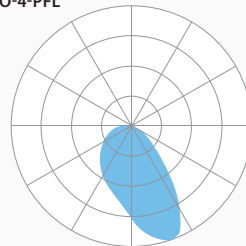

PFL NOT AVAILABLE WITH REG.3

UPTO **120** LPW

REG.5:	LO	MO	SO	HO
SAL Lm/Ft	425	625	840	1100
MGZ Lm/Ft	460	685	925	1200
PFL Lm/Ft	450	670	900	1175
W/Ft	3.8	5.6	7.8	10.5

LUMEN CHART AT 3500K-80 CRI

UPTO **119** LPW

REG.1:	LO	MO	SO	HO
SAL Lm/Ft	400	590	800	1040
MGZ Lm/Ft	460	685	925	1200
PFL Lm/Ft	435	640	885	1115
W/Ft	3.8	5.6	7.8	10.5

LUMEN CHART AT 3500K-80 CRI

UPTO **102** LPW

REG.3:	LO	MO	SO	HO
SAL Lm/Ft	300	460	650	800
MGZ Lm/Ft	400	590	800	1040
W/Ft	3.8	5.6	7.8	10.5

LUMEN CHART AT 3500K-80 CRI

Consult factory for Louver IES: marketing@prulite.com



ADJOINING DETAILS

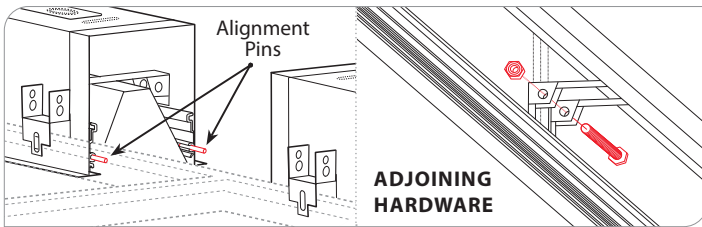

RTK: REMOTE TEST KIT

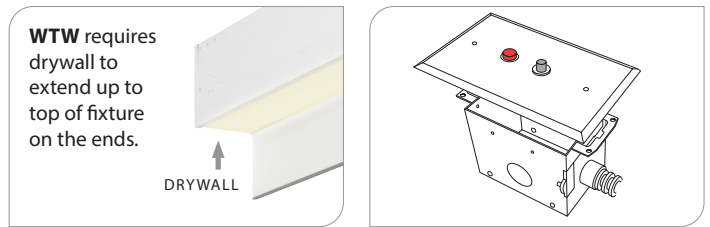

CEILING SYSTEMS

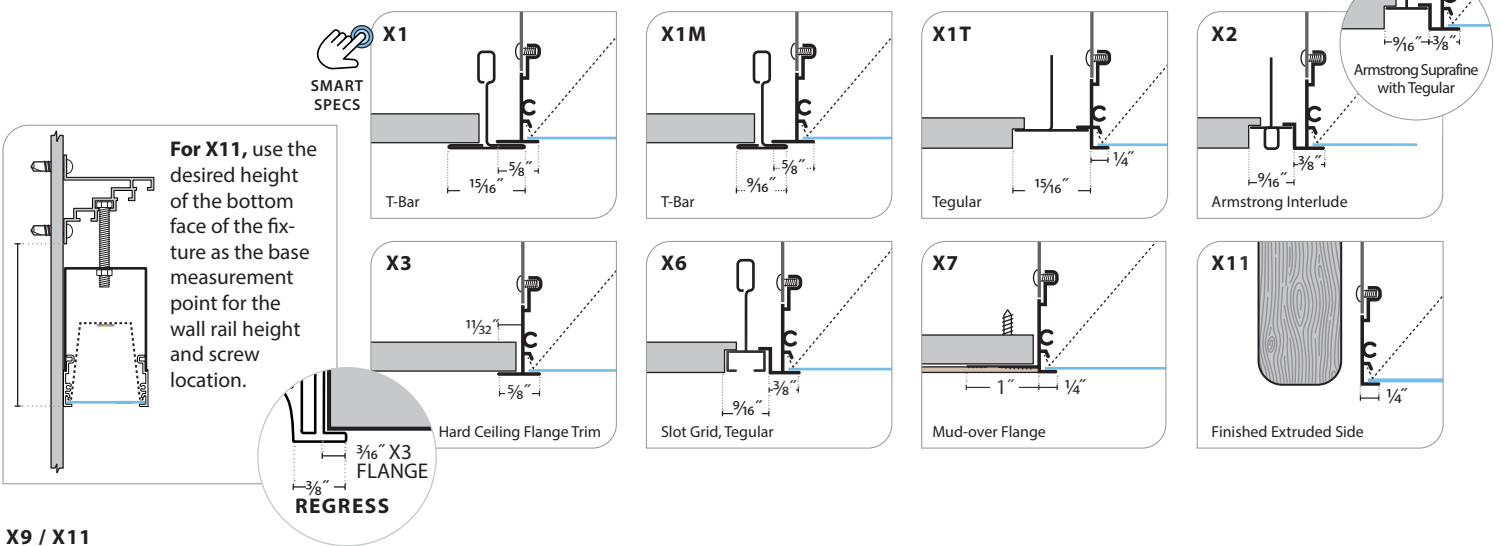

X9 / X11

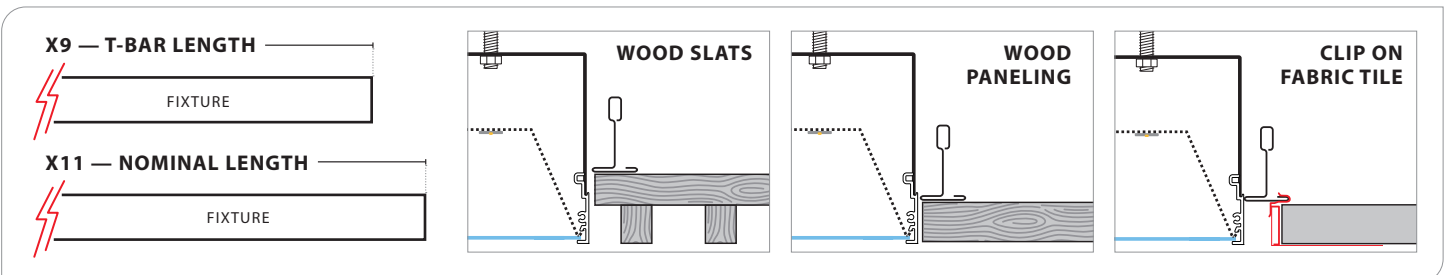



CORNERS

C2-60 (INSIDE+OUTSIDE):

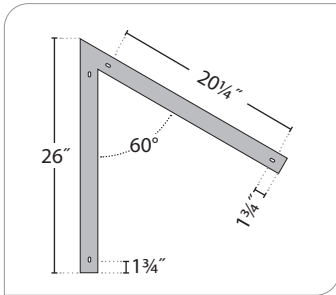

C2-90 (INSIDE+OUTSIDE):

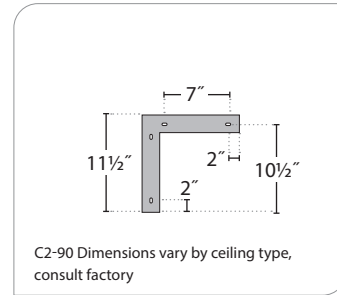

C2-120 (INSIDE+OUTSIDE):

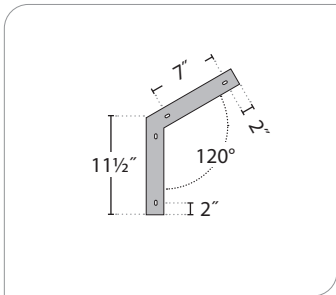

C2-135 (INSIDE+OUTSIDE):

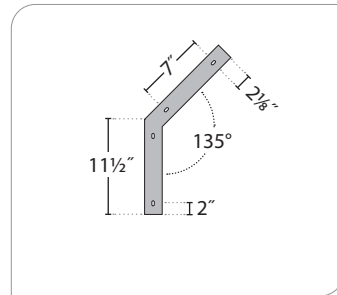

C3T (3-WAY):

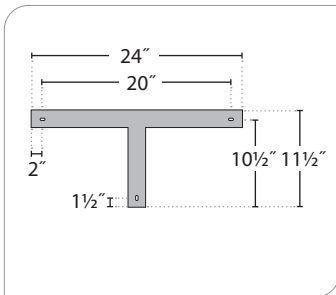

MOUNTING

LIGHT POCKET

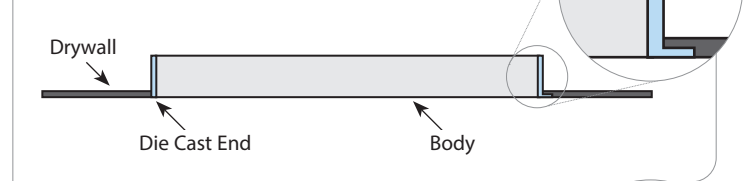

WALL-TO-WALL

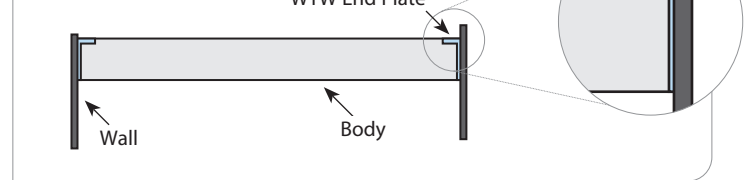

NOTE: LP and WTW odd length fixtures require a field-trimmed Filler fixture.



FTR END OF ROW FEATHERING

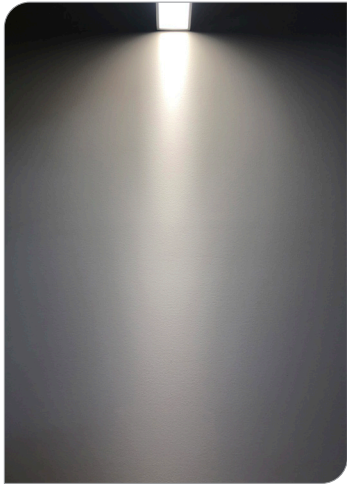

Wall to wall (WTW) fixtures can project strong lighting distributions on perpendicular wall which some find undesirable.

Medium Wall Graze (MGZ) shown above.

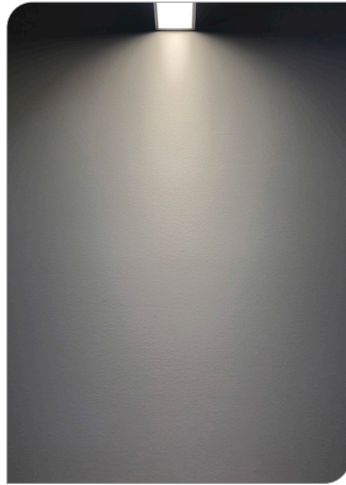

Feather (FTR) softens distributions on perpendicular walls.

Medium Wall Graze (MGZ) shown above with FTR.
NA with HO Output.

LGP LOW GLARE PRISMATIC LENS

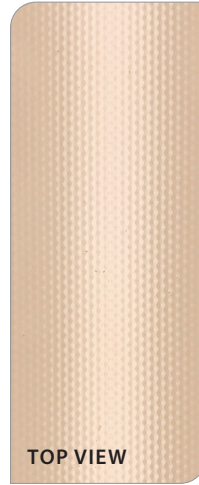

TOP VIEW



WELL OPTION 1 B,
FIXTURE UGR 16 OR LESS

Low Glare Prismatic lens has a dynamic 'prismatic stripe' that 'follows the viewer' and offers a sense of depth. The narrow distribution has low glare (UGR) and meets WELL UGR of 16 or lower. It utilizes the FTR Diffuser (see below).

NOTE: Our Batwing lens also meets WELL UGR of 16 or less (BioPro 3-4-5). NA with HO output.

FTR (FEATHERING DIFFUSER) DETAIL

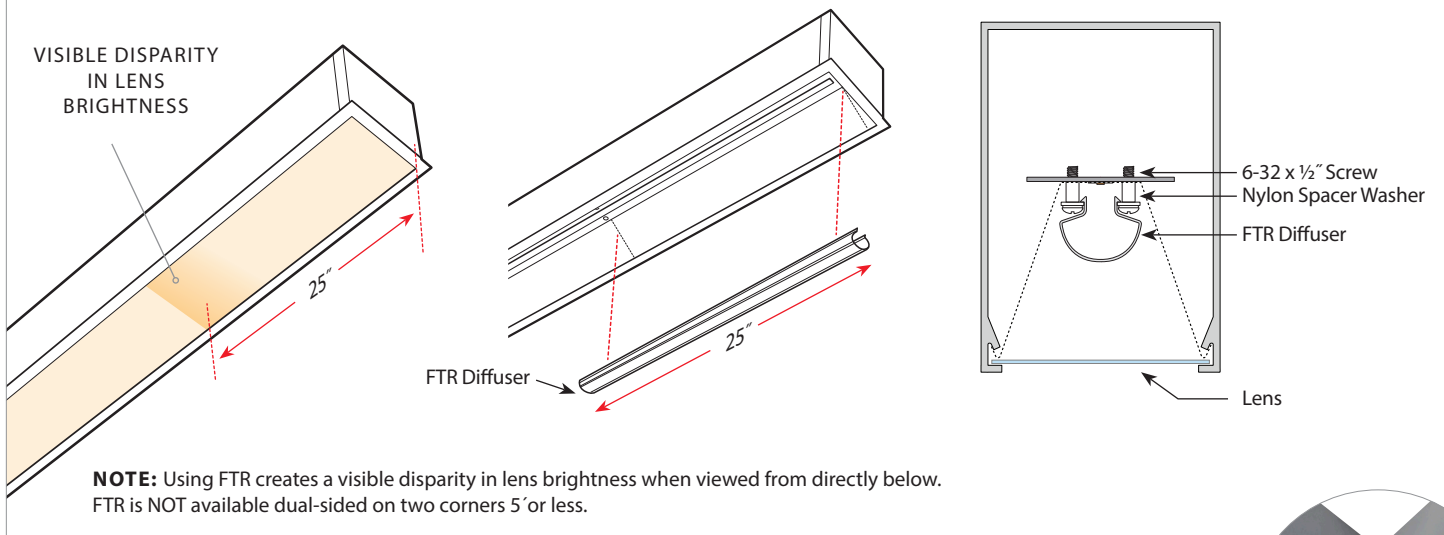

CAST ALUMINUM END CAPS

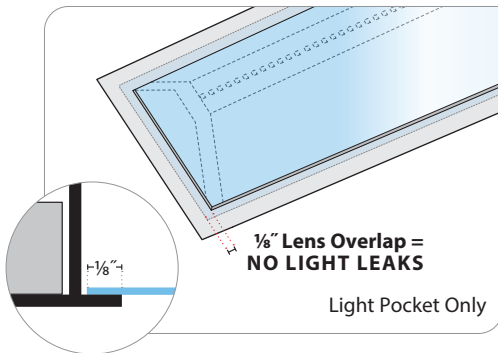

SENSOR PLATE



LOUVER DETAIL





**WALL TO GRID (T-BAR) DIMENSIONS:
CEILING OPENING (HARD CEILING) DIMENSIONS:**

X =	T-BAR (X1, X1M, X1T, X2, X6)	HARD CEILING (X3, X7)	X9 / X11
NO LOUVERS	3½"	3¾"	3⅛"
WITH LOUVERS	3⅝"	3⅝"	3½"

**XSR SHADOW REVEAL
(OPTIONAL)**

T-BAR (X1, X1M, X1T, X2, X6)	HARD CEILING (X3, X7)	X9 / X11
3⅝"	3¾"	3¼"
3⅜"	3½"	3⅝"

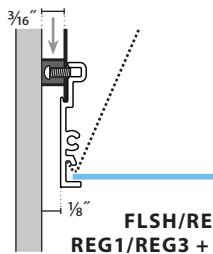
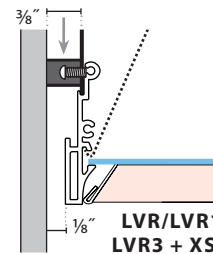
<p>UNTHREADED BUMPER P/N: 100-00368-14</p>  <p>FLSH/REG.5/ REG1/REG3 + XSR</p>	<p>UNTHREADED BUMPER P/N: 100-00369-14</p>  <p>LVR/LVR1/ LVR3 + XSR</p>
--	--

NOTE: X3 Hard Ceiling with Louver/Regress, fixtures **MUST** be installed before drywall

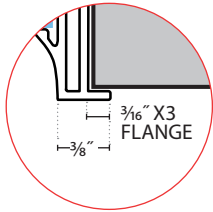

T-BAR — X1, X1M, X1T, X2, X6

**HARD CEILING — X3, X7, X11
T-BAR — X9**

FLSH:

FLSH:

T-BAR — X1, X1M, X1T, X2, X6

**HARD CEILING — X3, X7, X11
T-BAR — X9**

LVR:

REG.5:

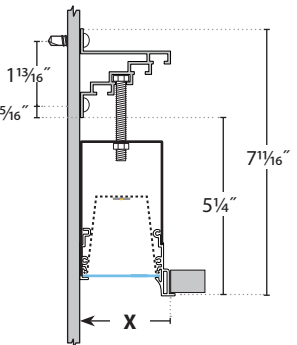
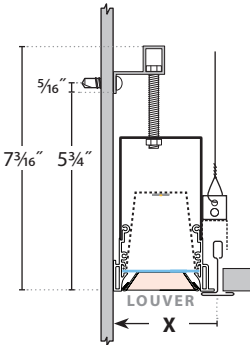
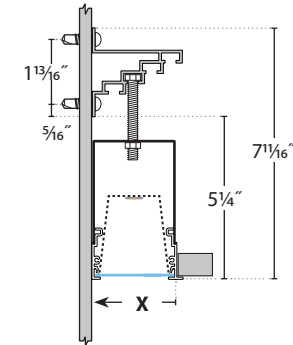
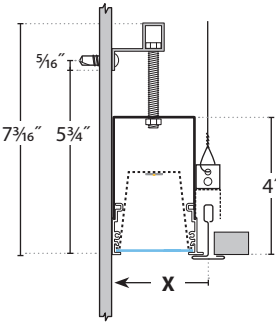

T-BAR — X1, X1M, X1T, X2, X6

**HARD CEILING — X3, X7, X11
T-BAR — X9**

REG1:

LVR1:

T-BAR — X1, X1M, X1T, X2, X6

**HARD CEILING — X3, X7, X11
T-BAR — X9**

REG3:

LVR3:

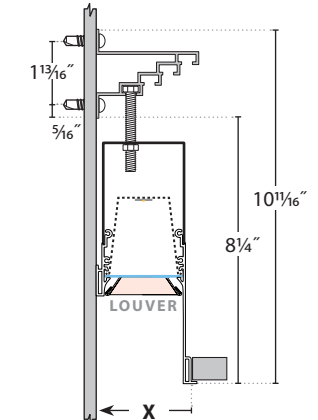
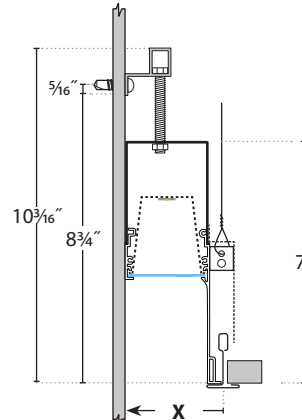
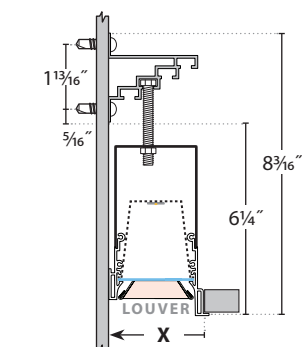
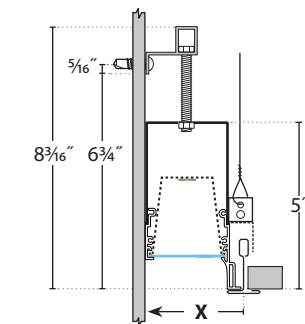



T-BAR — X1, X1M, X1T, X2, X6, X9

LIGHT POCKET (LP):

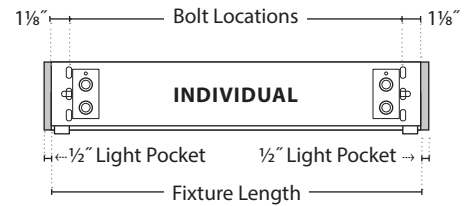
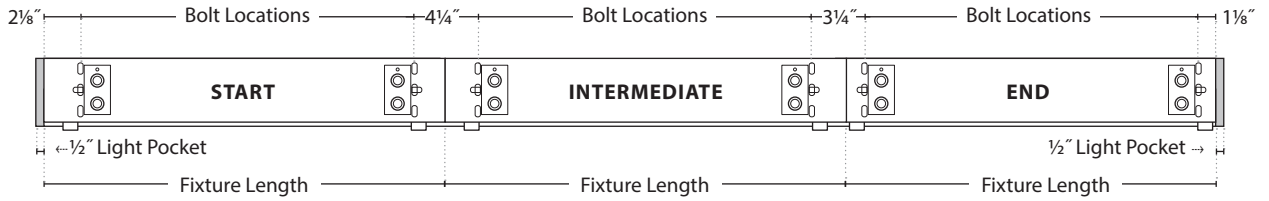

	FIXTURE LENGTHS		BOLT LOCATIONS
	Start / Intermediate	End / Individual	
2'	24"	22"	19 3/4"
3'	36"	34"	31 3/4"
4'	48"	46"	43 3/4"
5'	60"	58"	55 3/4"
6'	72"	70"	67 3/4"
7'	84"	82"	79 3/4"
8'	96"	94"	91 3/4"

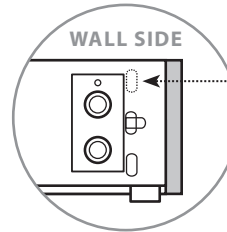

ALL BOLT LOCATIONS

WALL-TO-WALL (WTW):

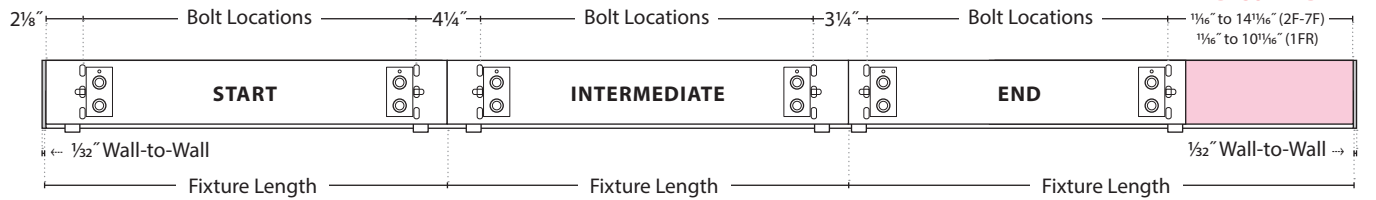

Bolt Locations Range for **FIELD CUTTABLE**

	FIXTURE LENGTH		BOLT LOCATIONS	
	Start / Intermediate	Filler	Start / Intermediate	Filler
—	—	—	—	—
2'	24"	16" - 26"	19 3/4"	14 1/8"
3'	36"	24" - 38"	31 3/4"	22 1/8"
4'	48"	36" - 50"	43 3/4"	34 1/8"
5'	60"	48" - 62"	55 3/4"	46 1/8"
6'	72"	60" - 74"	67 3/4"	58 1/8"
7'	84"	72" - 86"	79 3/4"	70 1/8"
8'	96"	84" - 98"	91 3/4"	82 1/8"

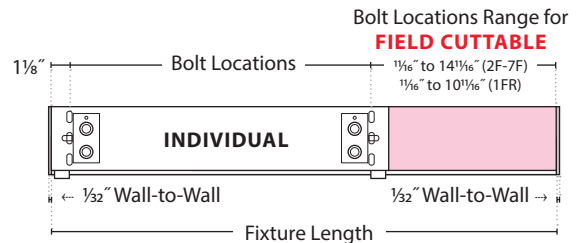

Bolt Locations Range for **FIELD CUTTABLE**

POWER FEED LOCATIONS:

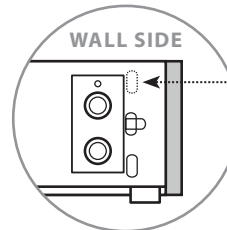
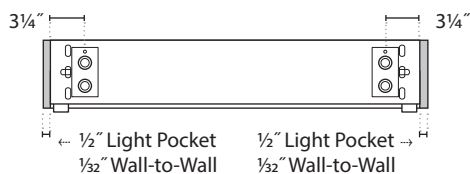

ALL BOLT LOCATIONS



T-BAR LENS INSTALL VIDEO



HARD CEILING — X3, X7, X11

LIGHT POCKET (LP):

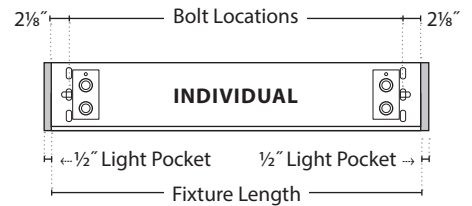
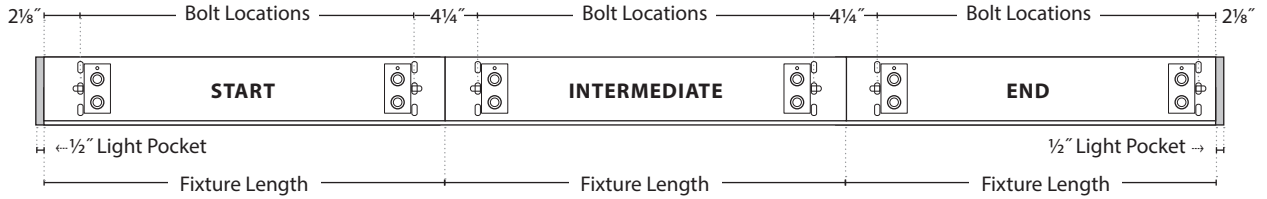

	FIXTURE LENGTHS				BOLT LOCATIONS			
	Start	Intermediate	End	Individual	Start	Intermediate	End	Individual
2'	24"				19 3/4"			
3'	36"				31 3/4"			
4'	48"				43 3/4"			
5'	60"				55 3/4"			
6'	72"				67 3/4"			
7'	84"				79 3/4"			
8'	96"				91 3/4"			

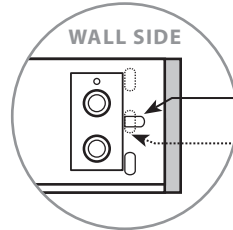

BOLT LOCATIONS
 XSR / LOUVER OPTIONS
 NON-XSR / NON-LOUVER OPTIONS

WALL-TO-WALL (WTW):

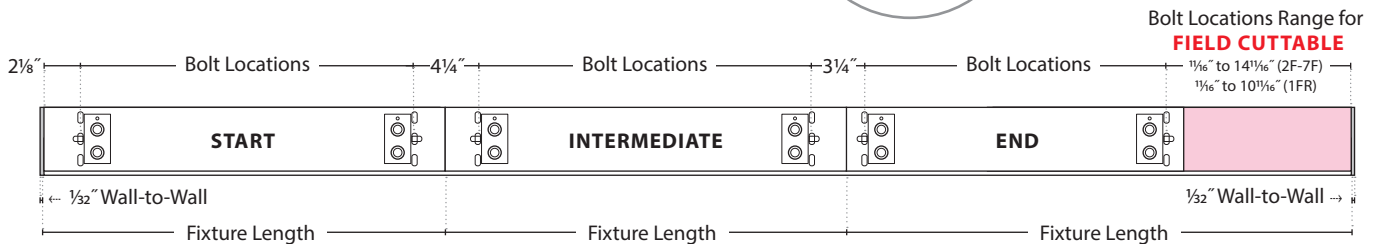

Bolt Locations Range for **FIELD CUTTABLE**
 1/16" to 14 1/16" (2F-7F)
 1/16" to 10 1/16" (1FR)

	FIXTURE LENGTH		BOLT LOCATIONS	
	Start / Intermediate	Filler	Start / Intermediate	Filler
—	—	—	—	—
2'	24"	16" - 26"	19 3/4"	14 1/8"
3'	36"	24" - 38"	31 3/4"	22 1/8"
4'	48"	36" - 50"	43 3/4"	34 1/8"
5'	60"	48" - 62"	55 3/4"	46 1/8"
6'	72"	60" - 74"	67 3/4"	58 1/8"
7'	84"	72" - 86"	79 3/4"	70 1/8"
8'	96"	84" - 98"	91 3/4"	82 1/8"

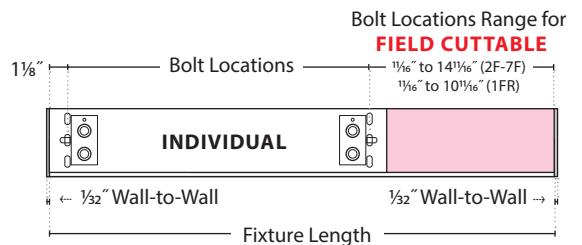

Bolt Locations Range for **FIELD CUTTABLE**
 1/16" to 14 1/16" (2F-7F)
 1/16" to 10 1/16" (1FR)

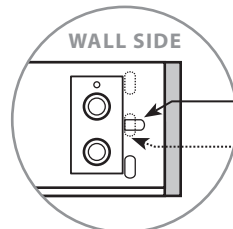

BOLT LOCATIONS
 XSR / LOUVER OPTIONS
 NON-XSR / NON-LOUVER OPTIONS

POWER FEED LOCATIONS:

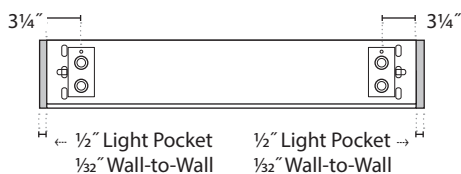



ROW BUILDER

LIGHT POCKET (LP):

ROW LENGTH	FIXTURE ROW
9'	4FT STR + 5FT END
10'	4FT STR + 6FT END
11'	4FT STR + 7FT END
12'	8FT STR + 4FT END
13'	8FT STR + 5FT END
14'	8FT STR + 6FT END
15'	8FT STR + 7FT END
16'	8FT STR + 8FT END
17'	4FT STR + (1) 8FT INT + 5FT END
18'	4FT STR + (1) 8FT INT + 6FT END
19'	4FT STR + (1) 8FT INT + 7FT END
20'	8FT STR + (1) 8FT INT + 4FT END
21'	8FT STR + (1) 8FT INT + 5FT END
22'	8FT STR + (1) 8FT INT + 6FT END
23'	8FT STR + (1) 8FT INT + 7FT END
24'	8FT STR + (1) 8FT INT + 8FT END
25'	4FT STR + (2) 8FT INT + 5FT END
26'	4FT STR + (2) 8FT INT + 6FT END
27'	4FT STR + (2) 8FT INT + 7FT END
28'	8FT STR + (2) 8FT INT + 4FT END
29'	8FT STR + (2) 8FT INT + 5FT END
30'	8FT STR + (2) 8FT INT + 6FT END
31'	8FT STR + (2) 8FT INT + 7FT END
32'	8FT STR + (2) 8FT INT + 8FT END
33'	4FT STR + (3) 8FT INT + 5FT END
34'	4FT STR + (3) 8FT INT + 6FT END
35'	4FT STR + (3) 8FT INT + 7FT END
36'	8FT STR + (3) 8FT INT + 4FT END
37'	8FT STR + (3) 8FT INT + 5FT END
38'	8FT STR + (3) 8FT INT + 6FT END
39'	8FT STR + (3) 8FT INT + 7FT END
40'	8FT STR + (3) 8FT INT + 8FT END
41'	4FT STR + (4) 8FT INT + 5FT END
42'	4FT STR + (4) 8FT INT + 6FT END
43'	4FT STR + (4) 8FT INT + 7FT END
44'	8FT STR + (4) 8FT INT + 4FT END
45'	8FT STR + (4) 8FT INT + 5FT END
46'	8FT STR + (4) 8FT INT + 6FT END
47'	8FT STR + (4) 8FT INT + 7FT END
48'	8FT STR + (4) 8FT INT + 8FT END
49'	4FT STR + (5) 8FT INT + 5FT END
50'	4FT STR + (5) 8FT INT + 6FT END

WALL-TO-WALL (WTW):

ROW LENGTH	FIXTURE ROW	MINIMUM FILLER LENGTH	MAXIMUM FILLER LENGTH
9'	4FT STR + 4FT FILLER	8' - 0" (96")	9' - 2" (110")
10'	4FT STR + 5FT FILLER	9' - 0" (108")	10' - 2" (122")
11'	4FT STR + 6FT FILLER	10' - 0" (120")	11' - 2" (134")
12'	4FT STR + 7FT FILLER	11' - 0" (132")	12' - 2" (146")
13'	8FT STR + 4FT FILLER	12' - 0" (144")	13' - 2" (158")
14'	8FT STR + 5FT FILLER	13' - 0" (156")	14' - 2" (170")
15'	8FT STR + 6FT FILLER	14' - 0" (168")	15' - 2" (182")
16'	8FT STR + 7FT FILLER	15' - 0" (180")	16' - 2" (194")
17'	4FT STR + (1) 8FT INT + 4FT FILLER	16' - 0" (192")	17' - 2" (206")
18'	4FT STR + (1) 8FT INT + 5FT FILLER	17' - 0" (204")	18' - 2" (218")
19'	4FT STR + (1) 8FT INT + 6FT FILLER	18' - 0" (216")	19' - 2" (230")
20'	4FT STR + (1) 8FT INT + 7FT FILLER	19' - 0" (228")	20' - 2" (242")
21'	8FT STR + (1) 8FT INT + 4FT FILLER	20' - 0" (240")	21' - 2" (254")
22'	8FT STR + (1) 8FT INT + 5FT FILLER	21' - 0" (252")	22' - 2" (266")
23'	8FT STR + (1) 8FT INT + 6FT FILLER	22' - 0" (264")	23' - 2" (278")
24'	8FT STR + (1) 8FT INT + 7FT FILLER	23' - 0" (276")	24' - 2" (290")
25'	4FT STR + (2) 8FT INT + 4FT FILLER	24' - 0" (288")	25' - 2" (302")
26'	4FT STR + (2) 8FT INT + 5FT FILLER	25' - 0" (300")	26' - 2" (314")
27'	4FT STR + (2) 8FT INT + 6FT FILLER	26' - 0" (312")	27' - 2" (326")
28'	4FT STR + (2) 8FT INT + 7FT FILLER	27' - 0" (324")	28' - 2" (338")
29'	8FT STR + (2) 8FT INT + 4FT FILLER	28' - 0" (336")	29' - 2" (350")
30'	8FT STR + (2) 8FT INT + 5FT FILLER	29' - 0" (348")	30' - 2" (362")
31'	8FT STR + (2) 8FT INT + 6FT FILLER	30' - 0" (360")	31' - 2" (374")
32'	8FT STR + (2) 8FT INT + 7FT FILLER	31' - 0" (372")	32' - 2" (386")
33'	4FT STR + (3) 8FT INT + 4FT FILLER	32' - 0" (384")	33' - 2" (398")
34'	4FT STR + (3) 8FT INT + 5FT FILLER	33' - 0" (396")	34' - 2" (410")
35'	4FT STR + (3) 8FT INT + 6FT FILLER	34' - 0" (408")	35' - 2" (422")
36'	4FT STR + (3) 8FT INT + 7FT FILLER	35' - 0" (420")	36' - 2" (434")
37'	8FT STR + (3) 8FT INT + 4FT FILLER	36' - 0" (432")	37' - 2" (446")
38'	8FT STR + (3) 8FT INT + 5FT FILLER	37' - 0" (444")	38' - 2" (458")
39'	8FT STR + (3) 8FT INT + 6FT FILLER	38' - 0" (456")	39' - 2" (470")
40'	8FT STR + (3) 8FT INT + 7FT FILLER	39' - 0" (468")	40' - 2" (482")
41'	4FT STR + (4) 8FT INT + 4FT FILLER	40' - 0" (480")	41' - 2" (494")
42'	4FT STR + (4) 8FT INT + 5FT FILLER	41' - 0" (492")	42' - 2" (506")
43'	4FT STR + (4) 8FT INT + 6FT FILLER	42' - 0" (504")	43' - 2" (518")
44'	4FT STR + (4) 8FT INT + 7FT FILLER	43' - 0" (516")	44' - 2" (530")
45'	8FT STR + (4) 8FT INT + 4FT FILLER	44' - 0" (528")	45' - 2" (542")
46'	8FT STR + (4) 8FT INT + 5FT FILLER	45' - 0" (540")	46' - 2" (554")
47'	8FT STR + (4) 8FT INT + 6FT FILLER	46' - 0" (552")	47' - 2" (566")
48'	8FT STR + (4) 8FT INT + 7FT FILLER	47' - 0" (564")	48' - 2" (578")
49'	4FT STR + (5) 8FT INT + 4FT FILLER	48' - 0" (576")	49' - 2" (590")
50'	4FT STR + (5) 8FT INT + 5FT FILLER	49' - 0" (588")	50' - 2" (602")



FILLER FIXTURES

1FR (REMOTE DRIVER):

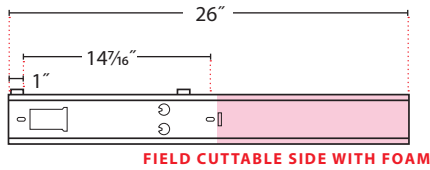

2F:

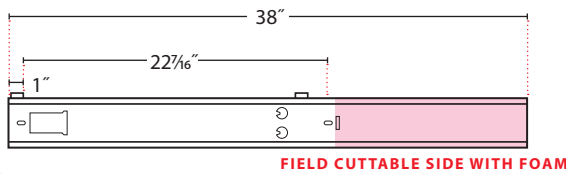

3F:

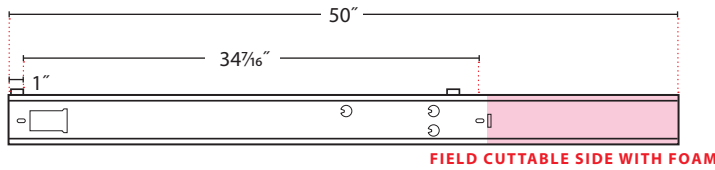

4F:

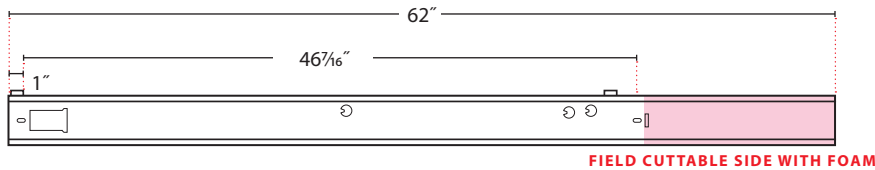

5F:

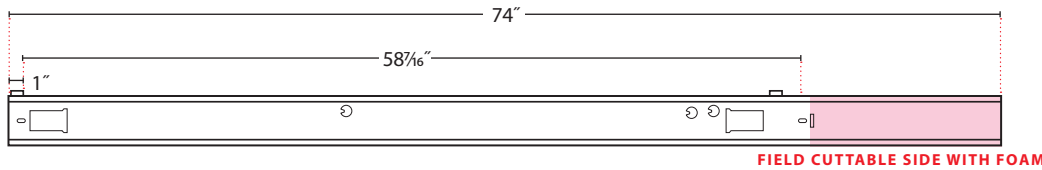

6F:

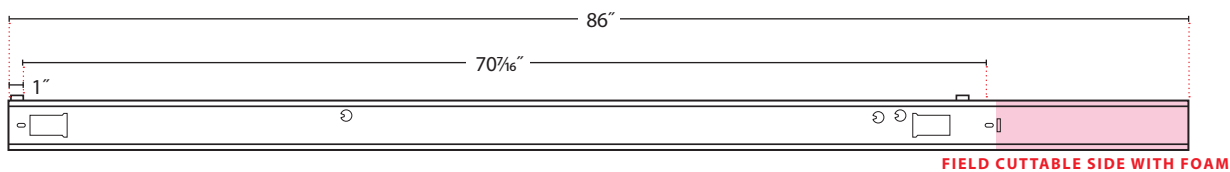

7F:

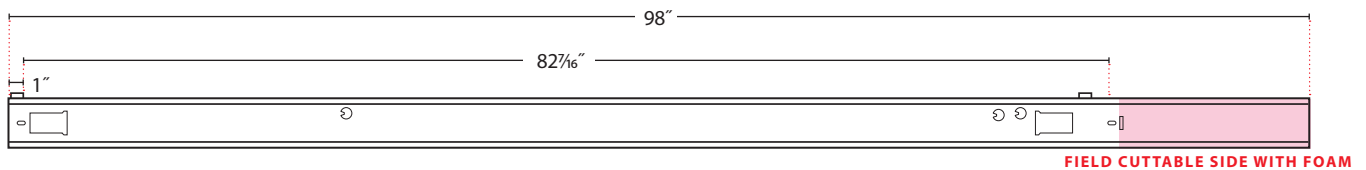

- Telescoping 2' – 8' fixtures. Fixtures adjust in length: 2' to 3', 4' to 5', 7' to 8', etc.
- Looks like a custom length fixture:
7' 8" = one field-adjusted fixture, no trim seams (seamless lens).
- Optical performance identical to standard fixtures.
- Much lower cost for wall-to-wall installs (one less fixture).
- Way easier installs, one cut, no assembly, installs like a standard fixture.



FILLER FIXTURE VIDEO

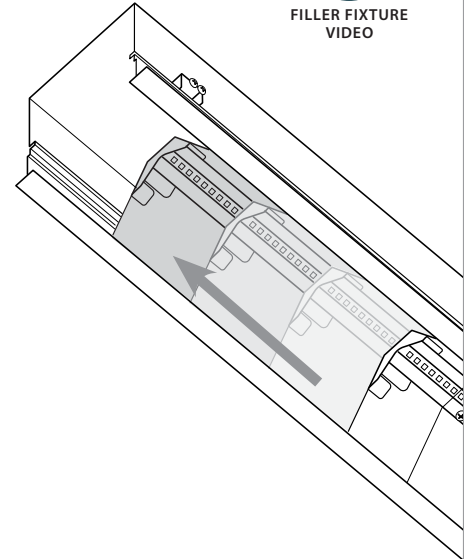

POWER ACCESS PLATE 1/4-20 MOUNTING HOLES



Medium Wall Graze (MGZ)

Wall grazing performance often better just off a wall.

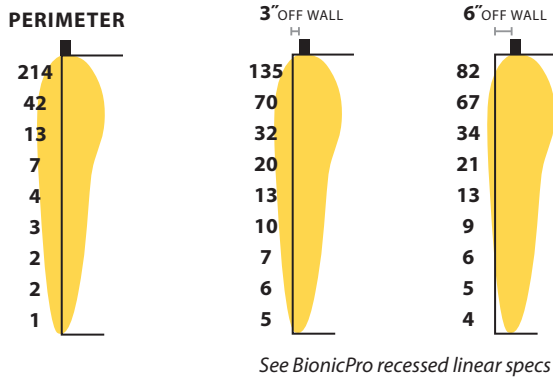

Perimeter Fill (PFL)

Wash a corridor in light from one side of the perimeter. Our Perimeter Fill is ideal for hospital corridors where a 50 fc average is needed.

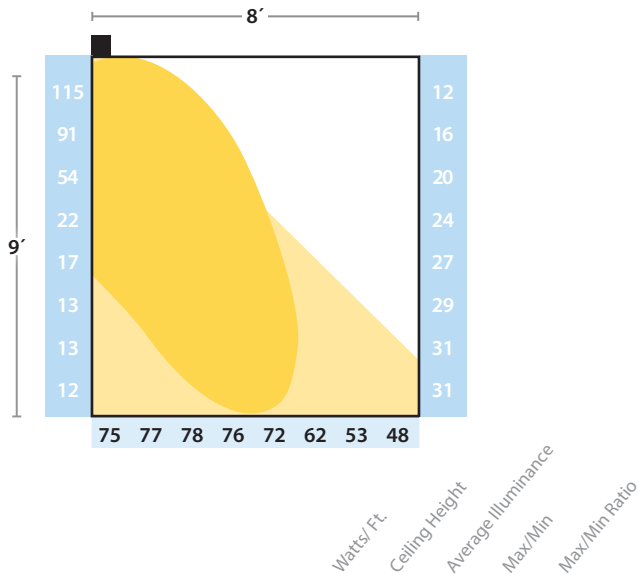



WIRING DIAGRAMS
SPEC



PRUDENTIAL LTG.

PRULITE.COM 213.746.0360

Lumen Outputs:				
	BLUHUE, TUHUE, TUHUE2, AMBERHUE			
DIRECT:	LO	MO	SO	HO*
SAL Lm/Ft	205	385	550	715
PFL Lm/Ft	215	395	565	730
LGP Lm/Ft	225	405	580	750
W/Ft	3.8	5.6	7.8	10.5

** TU2 + AMB NOT AVAILABLE HO / CHROMAHUE ONLY AVAILABLE ON HO



Prudential Lighting's **TuHue** Tunable White provides warm to cool white light simulating sunlight. Controlling the light source color temperature offers differing design aesthetics with potential benefits via circadian rhythm support. Blue light for alertness while warm light conveys tranquility.

- 2700K-6500K or 2200K-5000K.
- Adjust the color temperate and brightness separately.
- Simulates warm to cool to warm transition of sunlight.

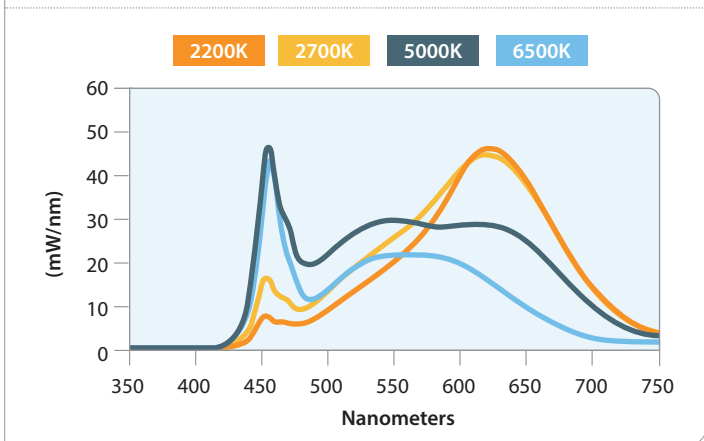
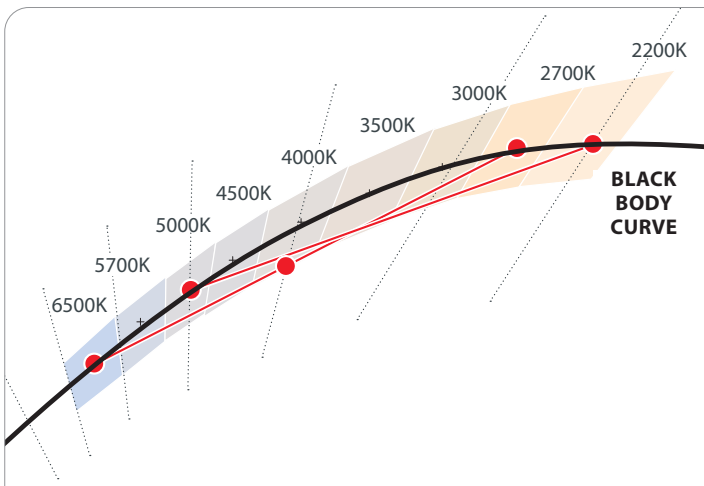

BluHue BIOS SkyBlue™ circadian LED lighting brings the benefits of blue skies inside. Newly discovered blue-sky receptors in our eyes drive improved daytime alertness, mood, brain function, and strengthens circadian rhythms leading to overall better health and well-being.

- Circadian rhythms play an integral role in physical and mental health.
- BluHue BIOS SkyBlue pinpoints peak 490nm sensitivity to provide the most benefit from an electric light source.
- At night, simply dim the lights to remove SkyBlue™ wavelengths (specify "Blu_D" to dim Cyan SkyBlue spike separately [night mode]).

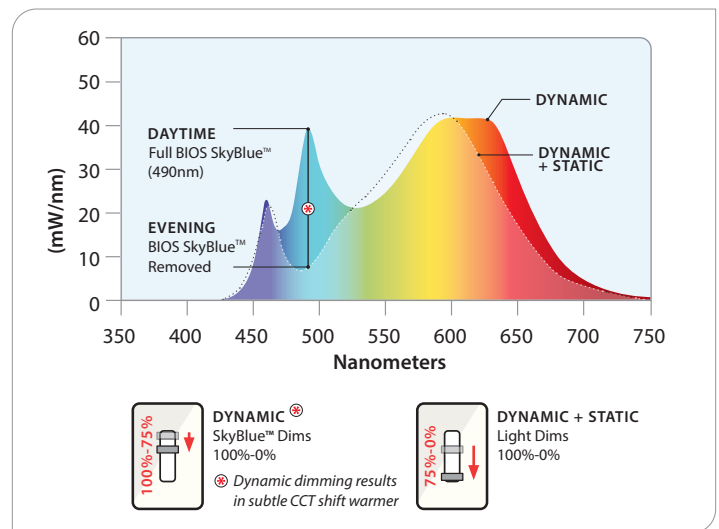

AmberHue is Prudential Lighting's Warm Dim offering. It transitions bright white light to warm amber light as brightness is dimmed, reflecting sunlight's transitioning from intense blue midday light to a dimmed golden hue near sunset, also reminiscent of soft glowing candlelight.

- Warm Dim 2200K-5000K.
- Color temperature warms as the luminaire is dimmed.
- Calm, relaxing mood communicated – hospitality, residential feel.

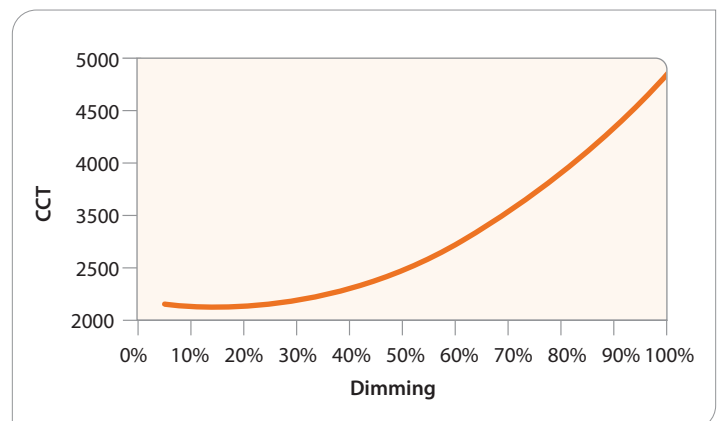



ChromaHue offers a vibrant full gamut of colors for seemingly endless architectural interior applications. Rich color-changing light offers tremendous design flexibility while white light can be achieved with the White chip, or mixing of Red, Green and Blue light. No longer just for the entertainment industry, ChromaHue can be intermixed on BionicPro luminaires for mood-creating indirect illumination combined with static white direct light.

- RGBW LED array (Red, Green, Blue, White) with full spectrum color and white light on the black body curve.
- Four-channel control, DMX drivers.
- Any color point within the triangle can be reached by setting the proper output levels for each individual red, green, blue and white channels.
- Standard DMX is one zone with one XLR drop at start, one XLR return at the end.

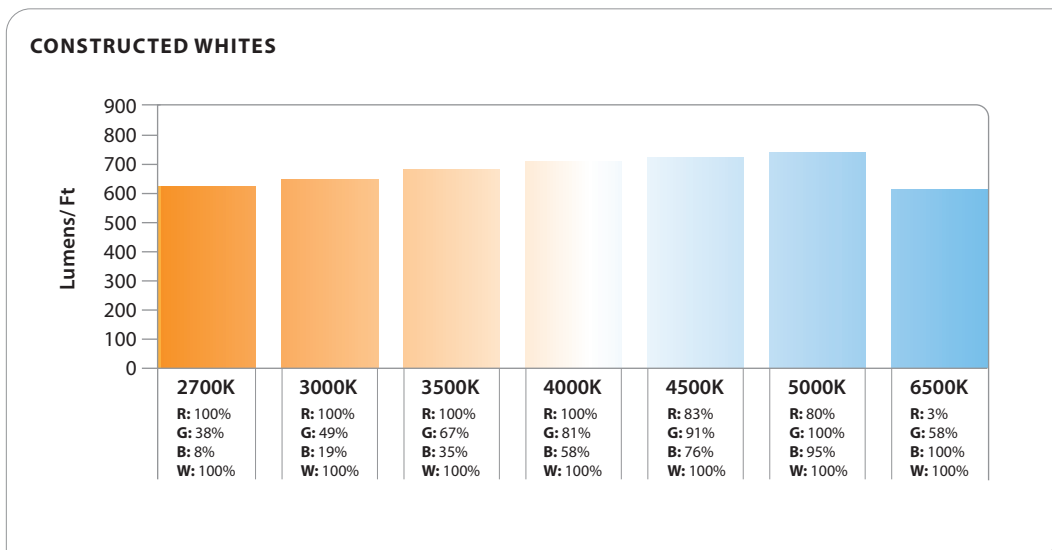
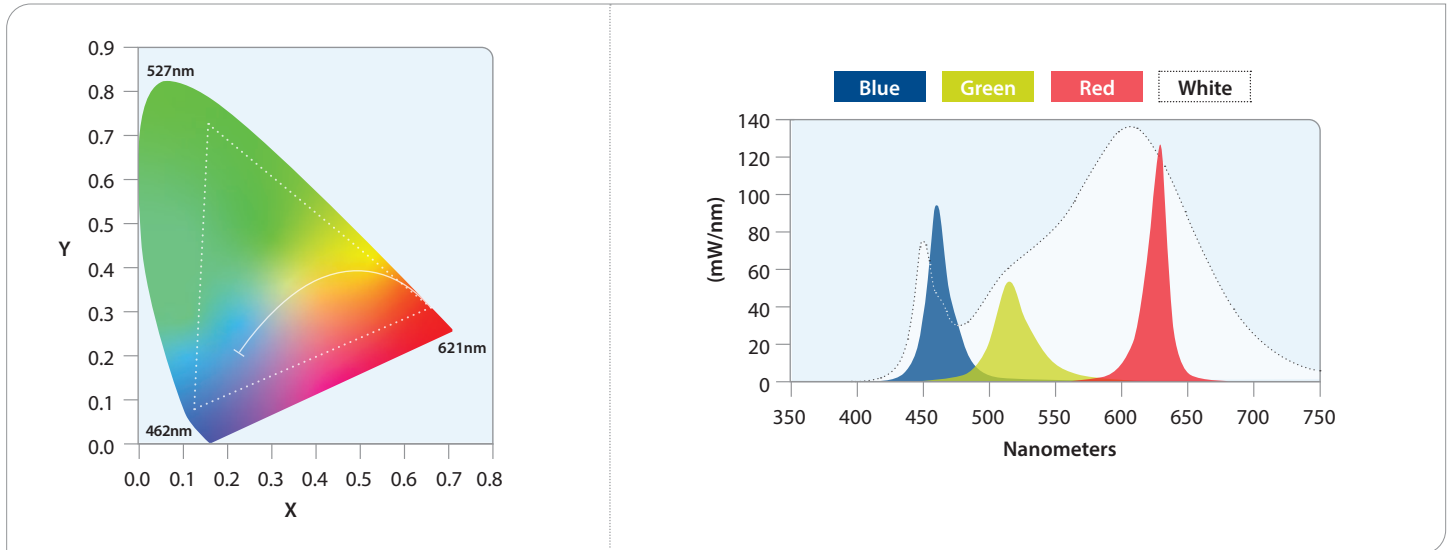



LM79 & TM30 DATA:

	MEASURED CCT	MEASURED LUMENS	CRI	R9	DuV	SPD	TM30 — COLOR VECTOR	TM30 — COLOR DISTORTION
LED27	2680	80%	93	58	0.001		 89 Rf	 97 Rg
LED3	3042	95%	82	6	0.001		 81 Rf	 92 Rg
LED3-90	3016	85%	93	61	0.000		 88 Rf	 96 Rg
LED35	3482	100%	82	3	0.002		 81 Rf	 92 Rg
LED35-90	3417	85%	93	67	0.000		 88 Rf	 96 Rg
LED4	3952	102%	82	4	0.003		 81 Rf	 92 Rg
LED4-90	3882	85%	92	67	0.003		 87 Rf	 96 Rg
LED5-90	4889	85%	94	84	0.002		 86 Rf	 95 Rg











LM79 & TM30 DATA:

		MEASURED CCT	MEASURED LUMENS	CRI	R9	LED27	SPD	TM30 — COLOR VECTOR
BH3S&D	bioS 3000K	2779	2758	87	81	0.003		
	BH3D SKY BLUE DIMMED	2715	2425	82	3	0.002		
BH35S&D	bioS 3500K	3245	2919	85	87	0.003		
	BH35D SKY BLUE DIMMED	3061	2502	83	7	0.001		
BH4&D	bioS 4000K	3624	2993	85	86	0.004		
	BH4D SKY BLUE DIMMED	3388	2585	83	5	0.002		
TH	LED27	2684	2456	92	57	0.0001		
	LED65	6061	3292	82	-1	0.006		
TH2	LED22	2209	2112	92	52	0.0005		
	LED50	4796	2789	93	77	0.004		
CH	2700K	2632	2469	82	50	0.003		
	3500K	3388	2585	83	5	0.002		
	4000K	3977	2682	83	29	0.003		
	5000K	5233	2823	84	21	0.003		



SENSORS

				
<p>205: Wattstopper</p>	<p>LVOC: Lutron Occupancy /Daylight Sensor</p>	<p>LVRF: Lutron Vive Control Node</p>	<p>NXSMP: Hubbell Occupancy /Daylight Sensor</p>	<p>ATHENA</p>
<p>Low voltage PIR fixture integrated occupancy sensor.</p>	<p>Measures light in the space (daylighting) while detecting people moving within an area using passive infrared to determine occupancy.</p> <p>Controls the lights to balance the light level in the space, combining convenience, exceptional energy savings, and ease of installation.</p>	<p>Provides wireless control of the fixture when neither occupancy nor daylight sensing is needed.</p>	<p>Hubbell Integrated/embedded networked lighting control, luminaire-level lighting control, LLLC.</p> <p>PIR motion sensor for automatic On/Off control.</p> <p>Integrated daylight sensor for daylight harvesting and/or lumen maintenance.</p> <p>Bluetooth radio provides wireless control of luminaire.</p> <p>Simple plug-in connection to NX Fixture Modules.</p> <p>Wireless Internet.</p>	<p>The Athena wireless node is a radio frequency (RF) device that enables simple, digital control of individual light fixtures in an Athena control system.</p> <p>The small size and compatibility with a wide variety of drivers allow for seamless integration with common commercial lighting fixtures from any manufacturer.</p> <p>Requires drivers with auxiliary power, consult factory for lead times</p>

			
<p>NLT-AIR-rIO: Daylight+Occ</p>	<p>NLT-AIR-ADCX: Daylight+(PIR Acoustic) Occ</p>	<p>NLT-WIRED-nIO: Daylight+Occ</p>	<p>NLT-WIRED-ADCX: Daylight+(PIR Acoustic) Occ</p>
<p>The rIO is a fixture embedded low voltage wireless nLight AIR device capable of individual fixture control and analog or digital dimming. This smart device results in the luminaire being “nLight AIR-enabled” — making it an addressable nLight AIR device. It uses a 900MHz radio to communicate with other nLight AIR devices, such as occupancy sensors, photocells, wall switches, powerpacks and other nLight AIR-enabled luminaires. This allows for advanced operation and design flexibility ranging from stand-alone rooms to building and campus-wide networks.</p>	<p>The nLight® AIR rES7 sensor is an in-fixture, low voltage, digital sensor providing embedded wireless lighting control, analog or digital dimming, occupancy detection and daylight harvesting capabilities.</p> <p>The rES7 is designed for mounting heights up to 20 ft in indoor luminaires. The rES7 sensor provides Passive Infrared (PIR) occupancy detection over a 15-20 ft (4.57 - 6.10 m) radial coverage pattern and photocell light level detection in one compact low profile design with optional Dual Technology, which adds Microphonics™ to PIR detection. The rES7 sensor is ideal for occupancy and daylighting control in suspended or recessed luminaires.</p>	<p>nLight digital nIO modules are low voltage control devices that enable digital control of LEDcode enabled eldoLED LED drivers. Through eldoLED's bi-directional 2-wire interface, these modules deliver natural, flicker-free high performance dimming while eliminating common issues related to 0-10 VDC alternatives. The modules also enable the eldoLED LED Drivers to be addressable, as well as capable of digitally communicating with other nLight controls such as occupancy sensors, photocells, and WallPods. This allows for advanced operation and design flexibility ranging from stand-alone rooms to building and campus-wide networks.</p>	<p>The nES7 is a small passive infrared occupancy sensor designed to be easily embedded into luminaires. This sensor provides excellent line of sight 360° PIR detection of small motion and walking motion. The nES7 is ideal for small rooms without obstructions or areas with primarily walking motion (e.g. corridors, library stacks). Additionally, an optional integrated photocell enables daylight harvesting control as well. Typically one or more nES7 sensors are paired with an nLight controller within an nLight enabled luminaire.</p> <p>For rooms like classrooms and private offices or any space with obstructions, the nES PDT 7 dual technology sensor is recommended.</p>