

BionicPro4™ | Perimeter Downlights

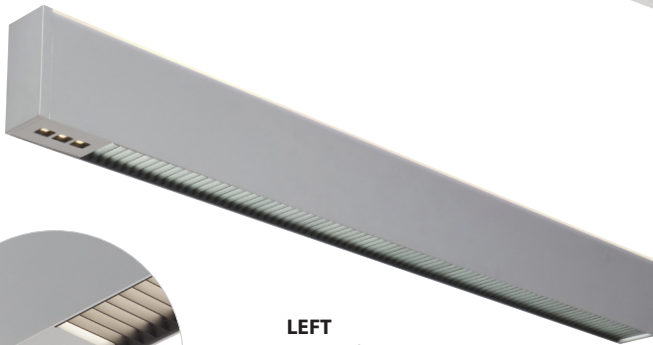

PRUDENTIAL LTG.

PRULITE.COM 213.746.0360



LEFT
(Start) Placement
(BPRO2 Linear shown with Louver)



MID
Middle of Row Placement
(BPRO4 Recessed shown with Flush Lens)

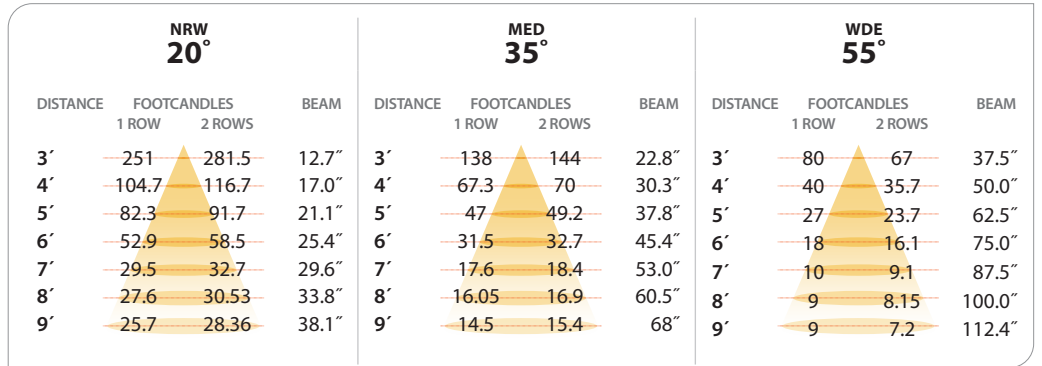
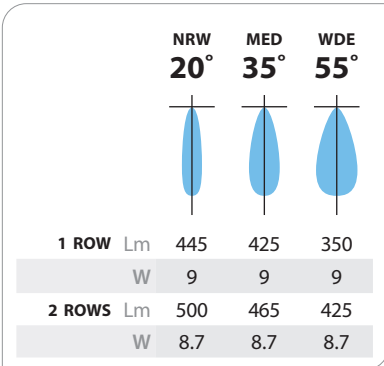

SE-RIES	QUANTITY	LOCATION	CCT	DISTRIBU-TION	COLOR	VOLTAGE	DRIVERS
DWN-LT							
Down-light	SPECIFY DOWN-LIGHT QUANTITY PER FIX-TURE/ROW Maximum One (1) Downlight Every 4' 16' Row = 4 Downlights 30' Row = 7 Downlights	MID One Downlight in Middle of Fixture LT One Downlight on Left (Start) RT One Downlight on Right (End) LT-RT Two Downlights on Ends LT-MID Two Downlights on Left and Middle MID-RT Two Downlights on Middle and End MOD Downlight Location(s) per Specs	LED3-90 3000K-90CRI (Standard) LED35-90 3500K-90CRI LED4-90 4000K-90CRI NOTES: - NA 2700K, 5000K - Only 1 Output Offered	NRW Nar-row 20° Beam MED Me-dium 35° Beam WDE Wide 55° Beam	TMW Textured Matte White (Standard) YGW Gloss White Y__ Premium Color CC Custom Color LUXE METALLICS: YBZ Bronze YCP Copper Penny YGN Gold Nuggetd Nugget	UNV (120-277) 347	DM01 0-10v, 1% Dimming (Standard) LDE1 Hi-lume 1% EcoSys-tem LED (Soft fade on, fade-to-black dimming) ECO 1% 0-10v, EldoLED (Loga-rithmic dimming std) ECDA 1% DALI, EldoLED (Logarithmic dimming std) SOLO 0.1% 0-10v, EldoLED (Dim-to-dark, Logarithmic dimming std) SODA 0.1% DALI, EldoLED (Dim-to-dark, Logarithmic dimming std)



LUMEN MAINTENANCE

- L70** — 200,000+ Hours
- L90** — 100,000+ Hours (LO, MO & SO)
- L90** — 60,000+ Hours (HO)

LED SYSTEM LED modules and drivers are field replaceable.

PROG (OPTIONAL) Programmable light output. Specify desired lumens or watts per linear foot.

BINNING Standard binning (all Prudential LED boards) includes testing at the chip level and board integration to provide consistent color temperature within a 3-step MacAdams ellipse, with +/- 5% lumen output range and +/- .004 Duv.

LABELS ETL damp labeled and I.B.E.W. manufactured.

WARRANTY Single-source, 5 year limited warranty covers standard components and construction.

ELECTRICAL Must specify LED dimming controls. LED fixtures have constant current driver(s) with less than 20% THD when loaded to a minimum of 60%. Drivers sink a maximum of 6mA per driver. DM01 LED drivers are 0-10V dimmable and are compatible with most 0-10V wall slide dimmers and direct 0-10V analog signal dimmers. Max driver size 1.65" w x 1.25" h.

CONSTRUCTION

Housing Extruded aluminum trim and side wall >25% PC recycled, 100% recyclable.

20-gauge steel top housing >20% PC recycled, 100% recyclable.

Die-Cast endcaps (LP), Formed steel endcaps (WTW)

Lens Seamless lens up to 200'. Consult factory for longer lengths. Polymer, 100% recyclable.

Weight 4 lbs / ft.

MOUNTING Recessed into drywall or t-bar ceilings or walls.

INSULATION DETECTOR (ID) FOR NON-IC RATED FIXTURES

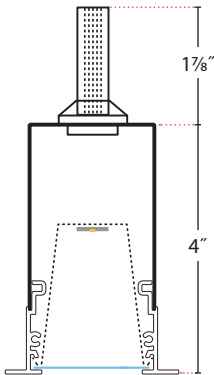

Insulation Detector (ID) REQUIRED for non IC-rated fixtures
Non IC-rated = **NO INSULATION ALLOWED**

ID REQUIRED for:

Osram	ELDO	Lutron & Signify	EMHE	Custom Length*	EMHE + Custom Length
—	—	—	—	HO	SO-HO

* Custom length = field adjustable, not 1' increments

Request **Insulation Detector Side Mount (IDSM)** if plenum less than 6"

FINISH COLORS

STANDARD:

TMW — Textured Matte White

YGW — Gloss White

PREMIUM:

YSW — Seashell White (Matte)

YPE — Pewter (Matte)

YRG — Rain Grey (Gloss)

YSTM — Storm Grey (Matte)

YBK — Black (Matte)

YBB — Black (Semi Gloss)

YSKM — Sky (Matte)

YMB — Military Blue (Matte)

YSAM — Sapphire (Matte)

YIB — Interstate Blue (Matte)

YBR — Bronze (Matte)

YSRM — Sunset Red (Matte)

YOR — Orange (Matte)

YDAM — Daffodil (Matte)

YFGM — Forest Green (Matte)

YSL — Silver (Metallic)

LUXE METALLICS:

YCP — Copper Penny (Metallic)

YBZ — Bronze (Metallic)

YGN — Gold Nugget (Metallic)

Choose from one of our Premium Colors with no set-up fee. For paint chip samples, please email: info@prulite.com



FLSH:

SATIN LENS

MEDIUM OUTPUT:

BPRO4-REC-FLSH-LED35-MO-SAL

2740 Delivered Lumens
23 Watts
120 lm/w
3500 CCT
1.22 Spacing Criteria

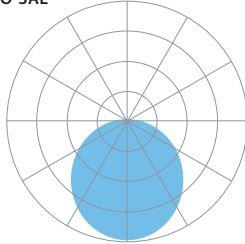

Zonal Lumen Summary:
0-90 = 100%

Vertical Angle	0°	25°	45°	65°	90°
0°	986	986	986	986	986
5°	980	980	977	982	982
15°	934	935	934	942	943
25°	852	852	854	865	869
35°	742	742	746	760	463
45°	613	612	617	630	639
55°	472	471	477	488	497
65°	323	323	329	339	348
75°	175	175	181	190	198
85°	37	37	42	49	56
90°	0	0	0	0	0

MEDIUM WALL GRAZER

LOW OUTPUT:

BPRO4-FLSH-LED35-LO-4-MGZ-DM01

1994 Delivered Lumens
15 Watts
133 lm/w
4000 CCT
18° FWHM

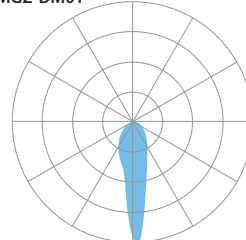

Zonal Lumen Summary:
0-90 = 100%

Vertical Angle	0°	25°	45°	65°	90°
90°	0	0	0	0	0
85°	32	32	26	25	27
75°	106	101	84	89	93
65°	175	162	148	179	189
55°	219	213	226	311	380
45°	274	282	315	471	722
35°	358	371	413	663	1225
25°	460	476	554	998	1782
15°	662	724	961	1627	2172
5°	1838	1951	2116	2338	2335
0°	2339	2339	2339	2339	2339

Vertical Angle	180°	202.5°	225°	247.5°	270°
5°	1549	1574	1771	2066	2335
15°	615	646	810	1337	2172
25°	442	453	515	838	1782
35°	349	358	394	587	1225
45°	262	268	304	426	722
55°	203	198	217	291	380
65°	165	148	144	172	189
75°	110	96	81	87	93
85°	36	31	23	24	27
90°	0	0	0	0	0

PERIMETER FILL

LOW OUTPUT:

BPRO4-FLSH-LED35-LO-4-PFL

1989 Delivered Lumens
15 Watts
132 lm/w
3500 CCT

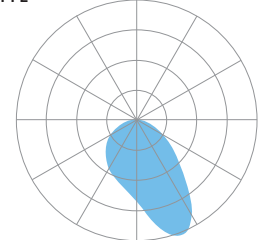

Zonal Lumen Summary:
0-90 = 100%

Vertical Angle	0°	25°	45°	65°	90°
90°	0	0	0	0	0
85°	23	24	28	30	30
75°	77	81	103	108	96
65°	153	165	225	224	166
55°	278	309	437	416	256
45°	513	574	756	629	370
35°	946	998	1014	746	487
25°	1205	1165	1006	794	600
15°	1022	997	910	810	693
5°	844	836	810	779	739
0°	747	747	747	747	747

Vertical Angle	180°	202.5°	225°	247.5°	270°
5°	644	658	810	779	739
15°	518	525	543	595	693
25°	458	461	468	497	600
35°	408	409	411	417	475
45°	403	403	405	416	487
55°	291	284	262	244	256
65°	222	210	183	160	166
75°	137	130	104	92	96
85°	42	42	33	29	30
90°	0	0	0	0	0

LOW GLARE PRISMATIC

STANDARD OUTPUT:

BPRO4-LED35-SO-LGP

3622 Delivered Lumens
32 Watts
113 lm/w
3500 CCT

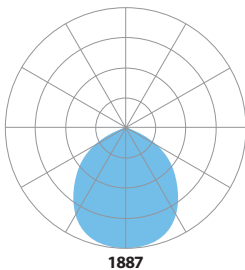

Zonal Lumen Summary:
0-90 = 100%

Vertical Angle	0°	25°	45°	65°	90°
0°	1887	1887	1887	1887	1887
5°	1883	1876	1866	1876	1878
15°	1802	1789	1765	1758	1752
25°	1631	1610	1562	1521	1500
35°	1381	1347	1253	1122	1061
45°	1070	1005	822	680	629
55°	696	594	459	380	351
65°	351	305	232	201	186
75°	147	134	100	95	87
85°	38	39	55	23	23
90°	0	0	0	0	0

Consult factory for Regress and Louver IES:

marketing@prulite.com



REG.5:

SATIN LENS

STANDARD OUTPUT:

BPRO4-PER-REG.5-LED35-SO-SAL

3683 Delivered Lumens
31 Watts
118 Lm/W
3500 CCT

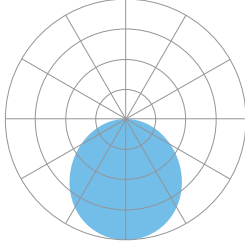

REG.1:

STANDARD OUTPUT:

BPRO4-PER-REG1-LED35-SO-4-SAL

3560 Delivered Lumens
31 Watts
115 Lm/W
3500 CCT

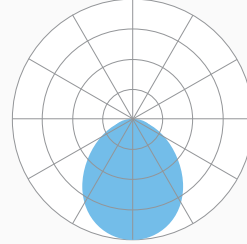

REG.3:

STANDARD OUTPUT:

BPRO4-PER-REG3-LED35-SO-4-SAL

3095 Delivered Lumens
31 Watts
100 Lm/W
3500 CCT

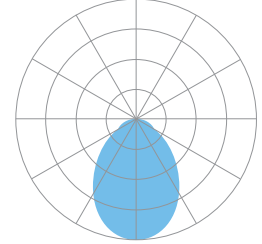

MEDIUM WALL GRAZER

STANDARD OUTPUT:

BPRO4-PER-REG.5-LED35-SO-4-MGZ

3879 Delivered Lumens
31 Watts
125 Lm/W
3500 CCT
16" FWHM

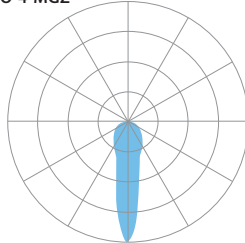

STANDARD OUTPUT:

BPRO4-PER-REG1-LED35-SO-4-MGZ

3791 Delivered Lumens
31 Watts
122 Lm/W
3500 CCT
16" FWHM

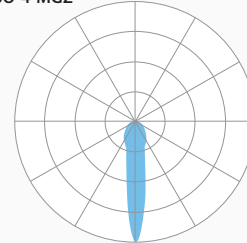

STANDARD OUTPUT:

BPRO4-PER-REG3-LED35-SO-4-MGZ

3455 Delivered Lumens
31 Watts
111 Lm/W
3500 CCT
16" FWHM

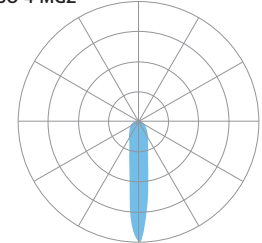

PERIMETER FILL

STANDARD OUTPUT:

BPRO4-PER-REG.5-LED35-SO-4-PFL

3826 Delivered Lumens
31 Watts
123 Lm/W
3500 CCT

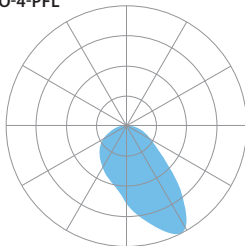

STANDARD OUTPUT:

BPRO4-PER-REG1-LED35-SO-4-PFL

3690 Delivered Lumens
32 Watts
119 Lm/W
3500 CCT

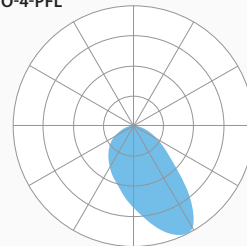

PFL NOT AVAILABLE WITH REG.3

UPTO **125** LPW

REG.5:	LO	MO	SO	HO
SAL Lm/Ft	450	670	900	1175
MGZ Lm/Ft	475	700	975	1225
PFL Lm/Ft	475	700	975	1225
W/Ft	3.8	5.6	7.8	10.5

LUMEN CHART AT 3500K-80 CRI

UPTO **119** LPW

REG.1:	LO	MO	SO	HO
SAL Lm/Ft	435	640	885	1115
MGZ Lm/Ft	460	685	925	1200
PFL Lm/Ft	450	670	900	1175
W/Ft	3.8	5.6	7.8	10.5

LUMEN CHART AT 3500K-80 CRI

UPTO **111** LPW

REG.3:	LO	MO	SO	HO
SAL Lm/Ft	375	560	750	975
MGZ Lm/Ft	435	640	885	1115
W/Ft	3.8	5.6	7.8	10.5

LUMEN CHART AT 3500K-80 CRI

Consult factory for Louver IES: marketing@prulite.com



ADJOINING DETAILS

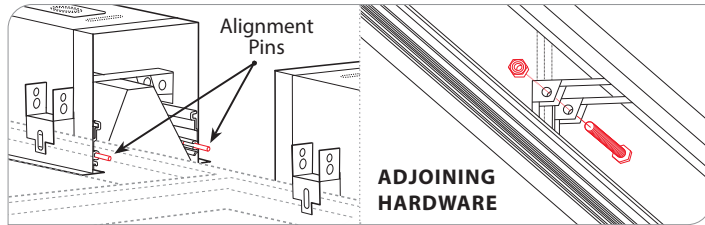

RTK: REMOTE TEST KIT

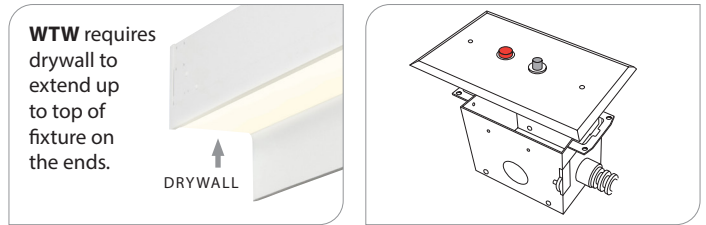

CEILING SYSTEMS

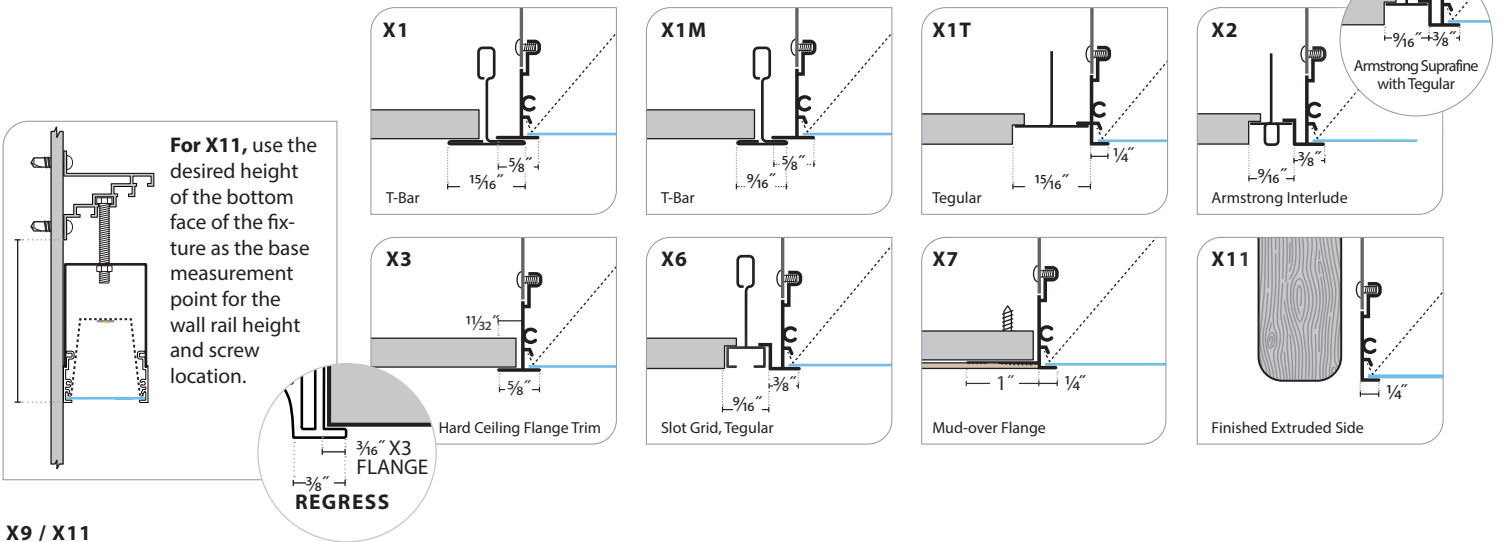

X9 / X11

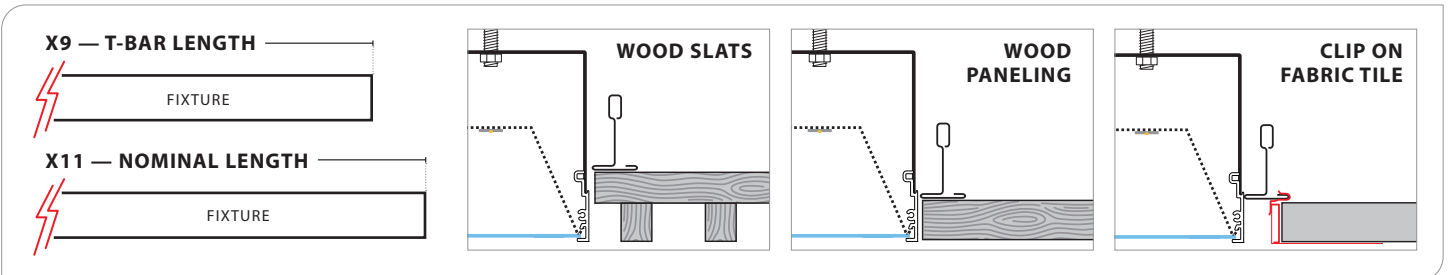



CORNERS

C2-60 (INSIDE+OUTSIDE):

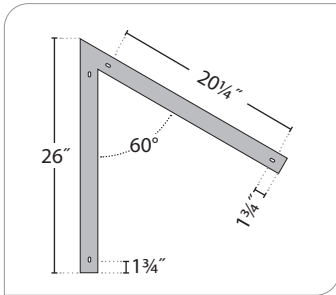

C2-90 (INSIDE+OUTSIDE):

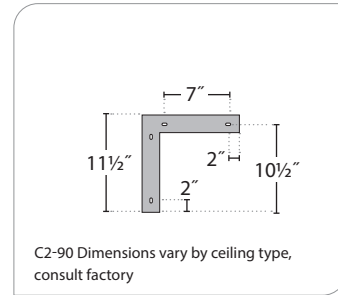

C2-120 (INSIDE+OUTSIDE):

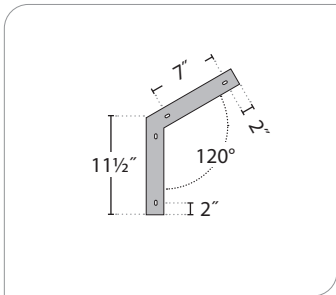

C2-135 (INSIDE+OUTSIDE):

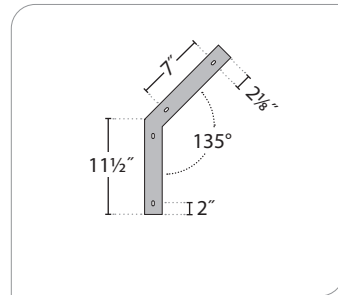

C3T (3-WAY):

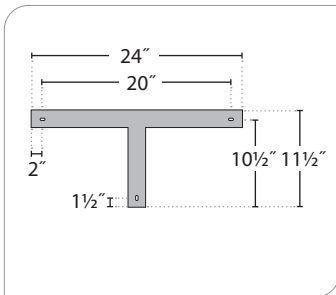

MOUNTING

LIGHT POCKET

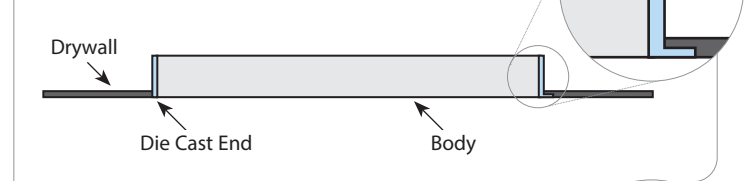

WALL-TO-WALL

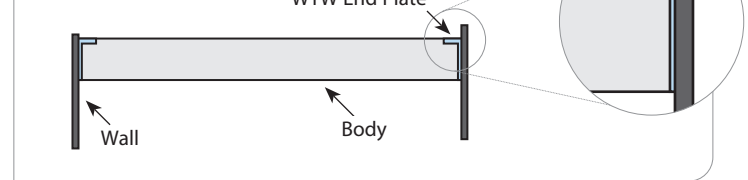

NOTE: LP and WTW odd length fixtures require a field-trimmed Filler fixture.

FTR END OF ROW FEATHERING

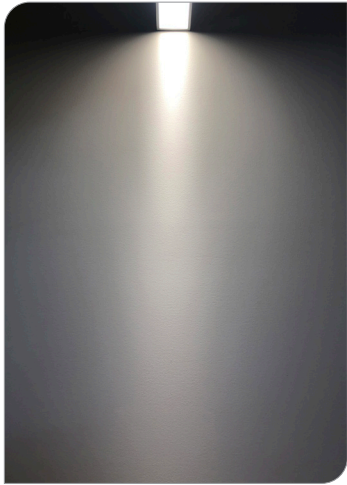

Wall to wall (WTW) fixtures can project strong lighting distributions on perpendicular wall which some find undesirable.

Medium Wall Graze (MGZ) shown above.

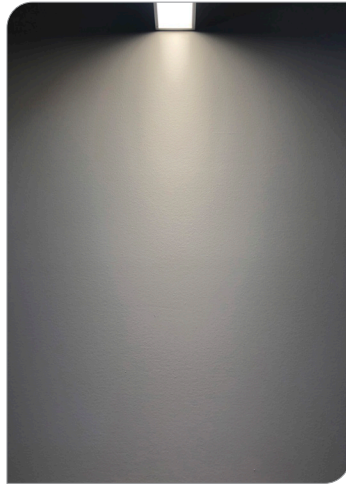

Feather (FTR) softens distributions on perpendicular walls.

Medium Wall Graze (MGZ) shown above with FTR NA with HO Output

LGP LOW GLARE PRISMATIC LENS

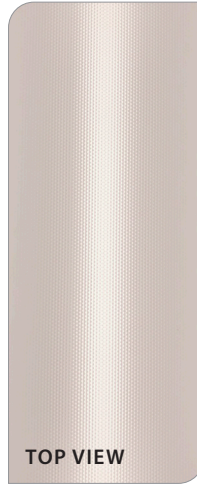

Low Glare Prismatic lens has a dynamic 'prismatic stripe' that 'follows the viewer' and offers a sense of depth. The narrow distribution has low glare (UGR) and meets WELL UGR of 16 or lower. It utilizes the FTR Diffuser (see below).

NOTE: Our Batwing lens also meets WELL UGR of 16 or less (BioPro 3-4-5). NA with HO output.



FTR (FEATHERING DIFFUSER) DETAIL

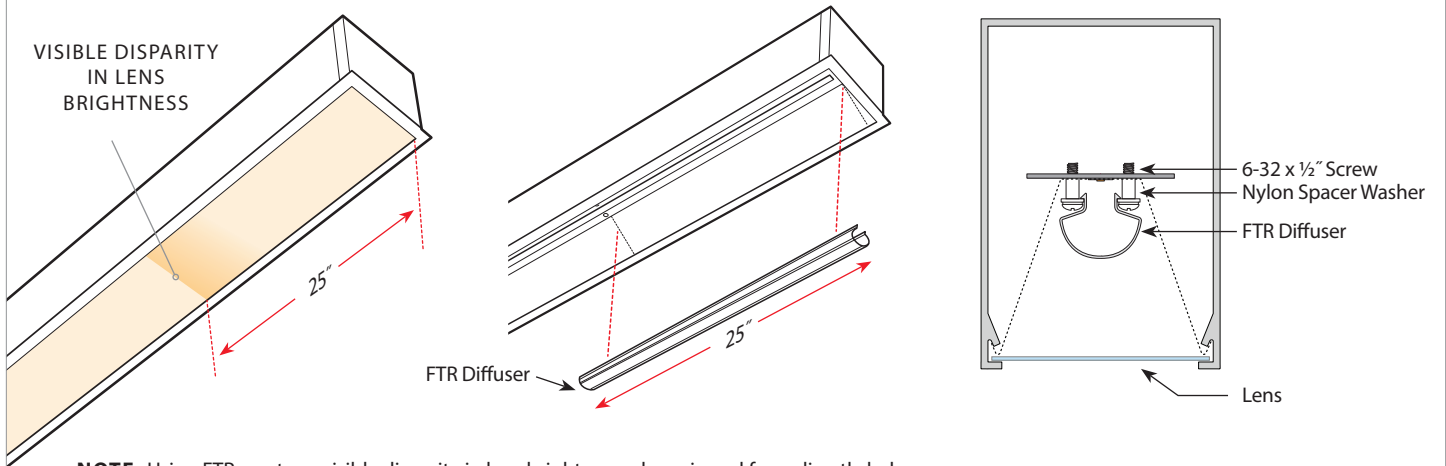

NOTE: Using FTR creates a visible disparity in lens brightness when viewed from directly below. FTR is NOT available dual-sided on two corners 5' or less.

CAST ALUMINUM END CAPS

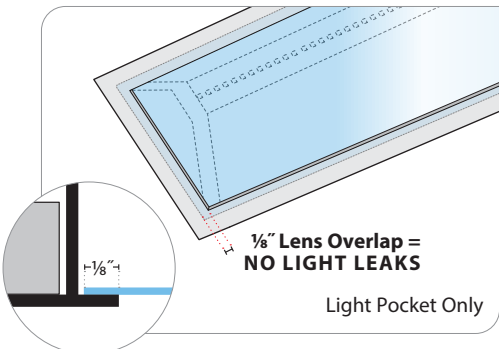

SENSOR PLATE



LOUVER DETAIL





**WALL TO GRID (T-BAR) DIMENSIONS:
CEILING OPENING (HARD CEILING) DIMENSIONS:**

X =	T-BAR (X1, X1M, X1T, X2, X6)	HARD CEILING (X3, X7)	X9 / X11
NO LOUVERS	4½"	4¾"	4⅛"
WITH LOUVERS	4⅝"	4⅝"	4½"

**XSR SHADOW REVEAL
(OPTIONAL)**

T-BAR (X1, X1M, X1T, X2, X6)	HARD CEILING (X3, X7)	X9 / X11
4⅝"	4⅝"	4¼"
4⅜⅙"	4½"	4⅝"

NOTE: X3 Hard Ceiling with Louver/Regress, fixtures **MUST** be installed before drywall

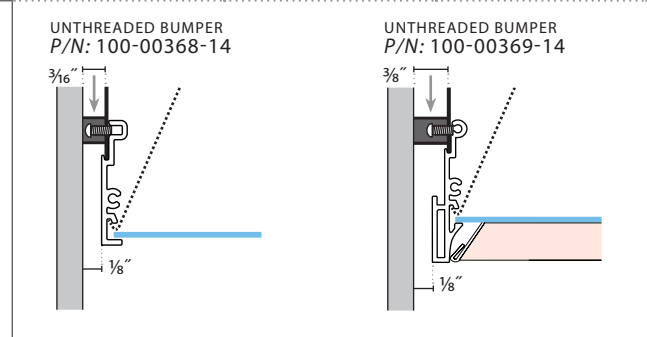
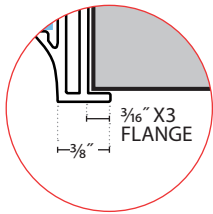

T-BAR — X1, X1M, X1T, X2, X6

**HARD CEILING — X3, X7, X11
T-BAR — X9**

T-BAR — X1, X1M, X1T, X2, X6

**HARD CEILING — X3, X7, X11
T-BAR — X9**

FLSH:

FLSH:

LVR:

REG.5:

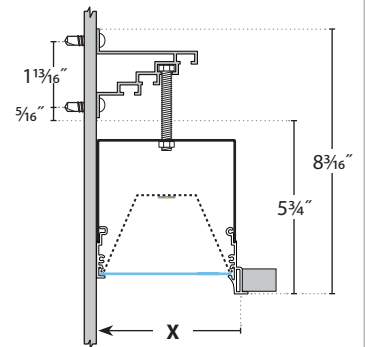
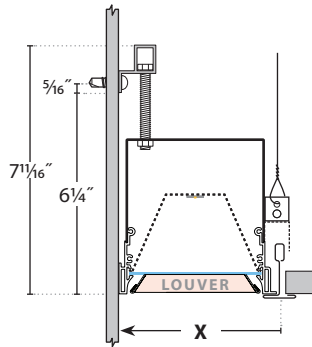
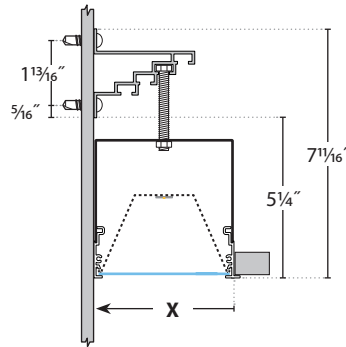
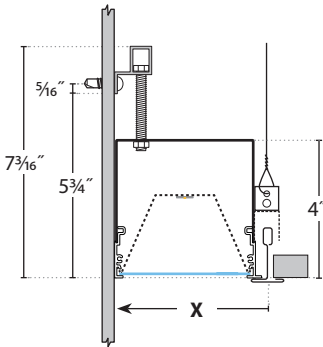

T-BAR — X1, X1M, X1T, X2, X6

**HARD CEILING — X3, X7, X11
T-BAR — X9**

T-BAR — X1, X1M, X1T, X2, X6

**HARD CEILING — X3, X7, X11
T-BAR — X9**

REG1:

LVR1:

REG3:

LVR3:

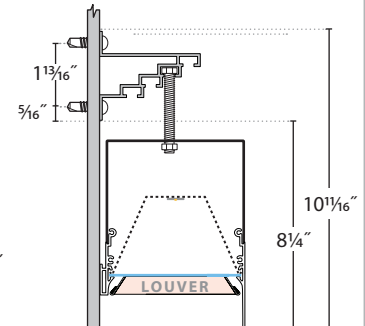
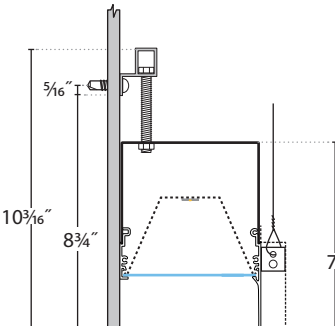
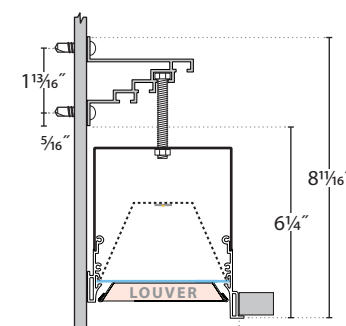
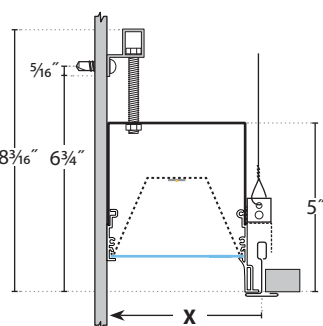



T-BAR — X1, X1M, X1T, X2, X6, X9

LIGHT POCKET (LP):

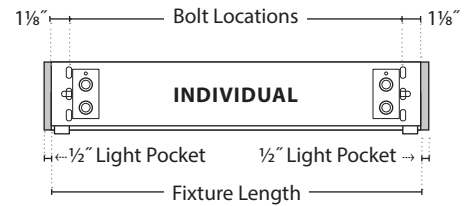
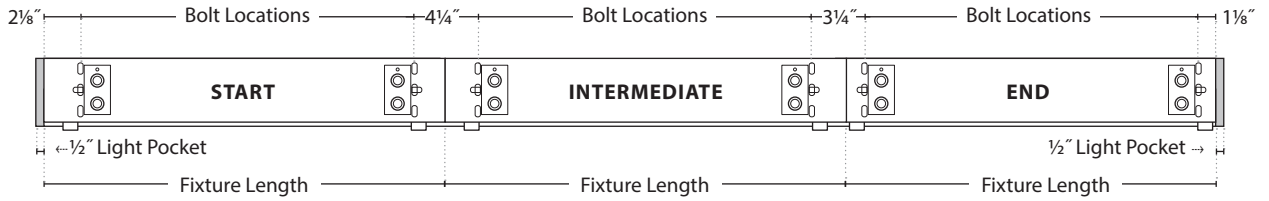

	FIXTURE LENGTHS		BOLT LOCATIONS
	Start / Intermediate	End / Individual	
2'	24"	22"	19 3/4"
3'	36"	34"	31 3/4"
4'	48"	46"	43 3/4"
5'	60"	58"	55 3/4"
6'	72"	70"	67 3/4"
7'	84"	82"	79 3/4"
8'	96"	94"	91 3/4"

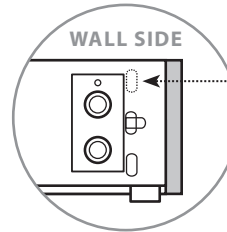

WALL-TO-WALL (WTW):

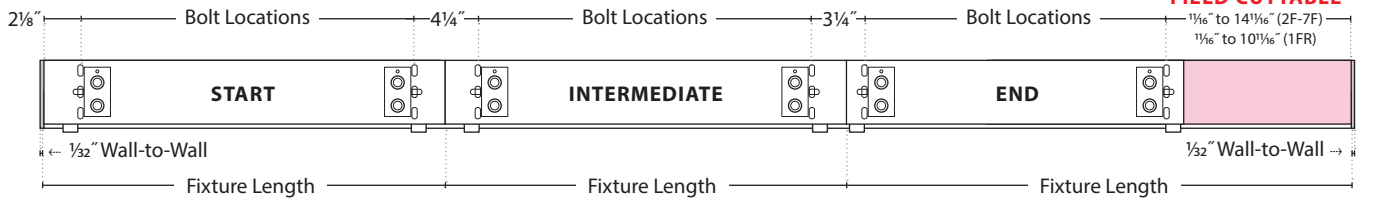

Bolt Locations Range for
FIELD CUTTABLE
1/16" to 14 1/16" (2F-7F)
1/16" to 10 1/16" (1FR)

	FIXTURE LENGTH		BOLT LOCATIONS	
	Start / Intermediate	Filler	Start / Intermediate	Filler
—	—	—	—	—
2'	24"	16" - 26"	19 3/4"	14 1/8"
3'	36"	24" - 38"	31 3/4"	22 1/8"
4'	48"	36" - 50"	43 3/4"	34 1/8"
5'	60"	48" - 62"	55 3/4"	46 1/8"
6'	72"	60" - 74"	67 3/4"	58 1/8"
7'	84"	72" - 86"	79 3/4"	70 1/8"
8'	96"	84" - 98"	91 3/4"	82 1/8"

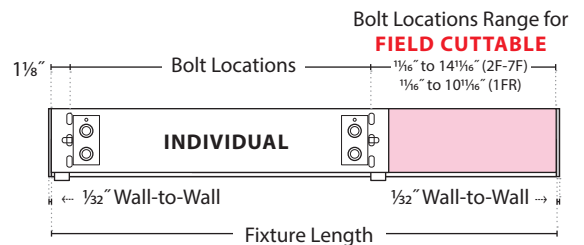

Bolt Locations Range for
FIELD CUTTABLE
1/16" to 14 1/16" (2F-7F)
1/16" to 10 1/16" (1FR)

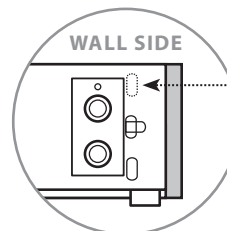

POWER FEED LOCATIONS:

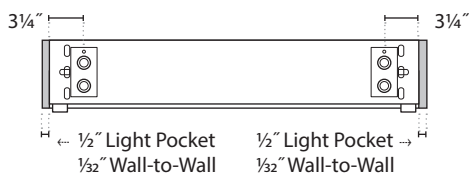



HARD CEILING — X3, X7, X11

LIGHT POCKET (LP):

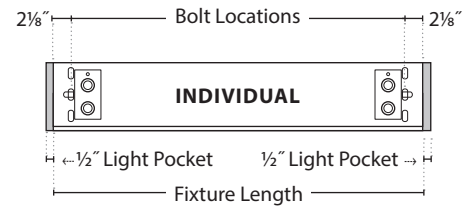
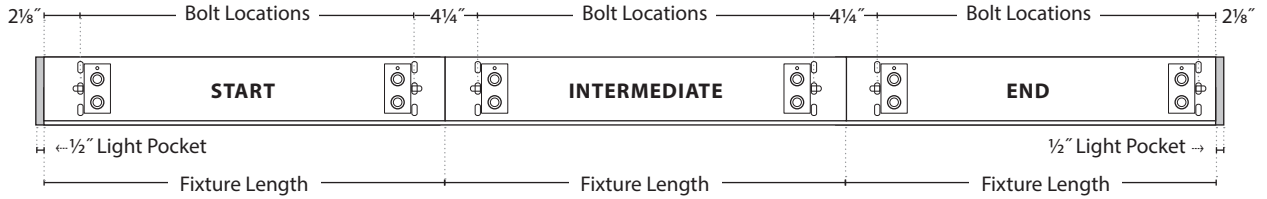

	FIXTURE LENGTHS				BOLT LOCATIONS			
	Start	Intermediate	End	Individual	Start	Intermediate	End	Individual
2'	24"				19 3/4"			
3'	36"				31 3/4"			
4'	48"				43 3/4"			
5'	60"				55 3/4"			
6'	72"				67 3/4"			
7'	84"				79 3/4"			
8'	96"				91 3/4"			

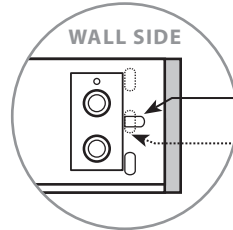

BOLT LOCATIONS
 XSR / LOUVER OPTIONS
 NON-XSR / NON-LOUVER OPTIONS

WALL-TO-WALL (WTW):

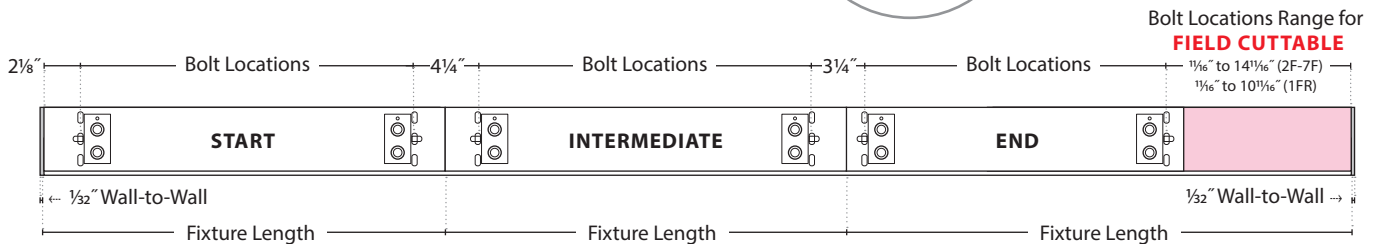

	FIXTURE LENGTH		BOLT LOCATIONS	
	Start / Intermediate	Filler	Start / Intermediate	Filler
—	—	—	—	—
2'	24"	16" - 26"	19 3/4"	14 1/8"
3'	36"	24" - 38"	31 3/4"	22 1/8"
4'	48"	36" - 50"	43 3/4"	34 1/8"
5'	60"	48" - 62"	55 3/4"	46 1/8"
6'	72"	60" - 74"	67 3/4"	58 1/8"
7'	84"	72" - 86"	79 3/4"	70 1/8"
8'	96"	84" - 98"	91 3/4"	82 1/8"

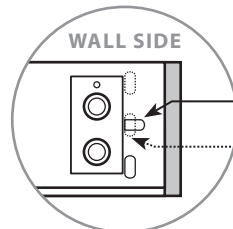
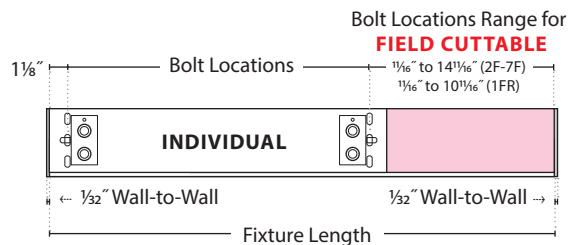

BOLT LOCATIONS
 XSR / LOUVER OPTIONS
 NON-XSR / NON-LOUVER OPTIONS

POWER FEED LOCATIONS:

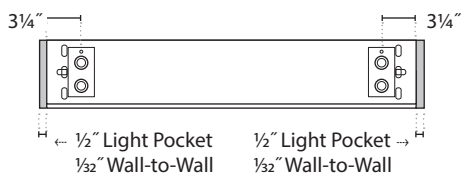



ROW BUILDER

LIGHT POCKET (LP):

ROW LENGTH	FIXTURE ROW
9'	4FT STR + 5FT END
10'	4FT STR + 6FT END
11'	4FT STR + 7FT END
12'	8FT STR + 4FT END
13'	8FT STR + 5FT END
14'	8FT STR + 6FT END
15'	8FT STR + 7FT END
16'	8FT STR + 8FT END
17'	4FT STR + (1) 8FT INT + 5FT END
18'	4FT STR + (1) 8FT INT + 6FT END
19'	4FT STR + (1) 8FT INT + 7FT END
20'	8FT STR + (1) 8FT INT + 4FT END
21'	8FT STR + (1) 8FT INT + 5FT END
22'	8FT STR + (1) 8FT INT + 6FT END
23'	8FT STR + (1) 8FT INT + 7FT END
24'	8FT STR + (1) 8FT INT + 8FT END
25'	4FT STR + (2) 8FT INT + 5FT END
26'	4FT STR + (2) 8FT INT + 6FT END
27'	4FT STR + (2) 8FT INT + 7FT END
28'	8FT STR + (2) 8FT INT + 4FT END
29'	8FT STR + (2) 8FT INT + 5FT END
30'	8FT STR + (2) 8FT INT + 6FT END
31'	8FT STR + (2) 8FT INT + 7FT END
32'	8FT STR + (2) 8FT INT + 8FT END
33'	4FT STR + (3) 8FT INT + 5FT END
34'	4FT STR + (3) 8FT INT + 6FT END
35'	4FT STR + (3) 8FT INT + 7FT END
36'	8FT STR + (3) 8FT INT + 4FT END
37'	8FT STR + (3) 8FT INT + 5FT END
38'	8FT STR + (3) 8FT INT + 6FT END
39'	8FT STR + (3) 8FT INT + 7FT END
40'	8FT STR + (3) 8FT INT + 8FT END
41'	4FT STR + (4) 8FT INT + 5FT END
42'	4FT STR + (4) 8FT INT + 6FT END
43'	4FT STR + (4) 8FT INT + 7FT END
44'	8FT STR + (4) 8FT INT + 4FT END
45'	8FT STR + (4) 8FT INT + 5FT END
46'	8FT STR + (4) 8FT INT + 6FT END
47'	8FT STR + (4) 8FT INT + 7FT END
48'	8FT STR + (4) 8FT INT + 8FT END
49'	4FT STR + (5) 8FT INT + 5FT END
50'	4FT STR + (5) 8FT INT + 6FT END

WALL-TO-WALL (WTW):

ROW LENGTH	FIXTURE ROW	MINIMUM FILLER LENGTH	MAXIMUM FILLER LENGTH
9'	4FT STR + 4FT FILLER	8' - 0" (96")	9' - 2" (110")
10'	4FT STR + 5FT FILLER	9' - 0" (108")	10' - 2" (122")
11'	4FT STR + 6FT FILLER	10' - 0" (120")	11' - 2" (134")
12'	4FT STR + 7FT FILLER	11' - 0" (132")	12' - 2" (146")
13'	8FT STR + 4FT FILLER	12' - 0" (144")	13' - 2" (158")
14'	8FT STR + 5FT FILLER	13' - 0" (156")	14' - 2" (170")
15'	8FT STR + 6FT FILLER	14' - 0" (168")	15' - 2" (182")
16'	8FT STR + 7FT FILLER	15' - 0" (180")	16' - 2" (194")
17'	4FT STR + (1) 8FT INT + 4FT FILLER	16' - 0" (192")	17' - 2" (206")
18'	4FT STR + (1) 8FT INT + 5FT FILLER	17' - 0" (204")	18' - 2" (218")
19'	4FT STR + (1) 8FT INT + 6FT FILLER	18' - 0" (216")	19' - 2" (230")
20'	4FT STR + (1) 8FT INT + 7FT FILLER	19' - 0" (228")	20' - 2" (242")
21'	8FT STR + (1) 8FT INT + 4FT FILLER	20' - 0" (240")	21' - 2" (254")
22'	8FT STR + (1) 8FT INT + 5FT FILLER	21' - 0" (252")	22' - 2" (266")
23'	8FT STR + (1) 8FT INT + 6FT FILLER	22' - 0" (264")	23' - 2" (278")
24'	8FT STR + (1) 8FT INT + 7FT FILLER	23' - 0" (276")	24' - 2" (290")
25'	4FT STR + (2) 8FT INT + 4FT FILLER	24' - 0" (288")	25' - 2" (302")
26'	4FT STR + (2) 8FT INT + 5FT FILLER	25' - 0" (300")	26' - 2" (314")
27'	4FT STR + (2) 8FT INT + 6FT FILLER	26' - 0" (312")	27' - 2" (326")
28'	4FT STR + (2) 8FT INT + 7FT FILLER	27' - 0" (324")	28' - 2" (338")
29'	8FT STR + (2) 8FT INT + 4FT FILLER	28' - 0" (336")	29' - 2" (350")
30'	8FT STR + (2) 8FT INT + 5FT FILLER	29' - 0" (348")	30' - 2" (362")
31'	8FT STR + (2) 8FT INT + 6FT FILLER	30' - 0" (360")	31' - 2" (374")
32'	8FT STR + (2) 8FT INT + 7FT FILLER	31' - 0" (372")	32' - 2" (386")
33'	4FT STR + (3) 8FT INT + 4FT FILLER	32' - 0" (384")	33' - 2" (398")
34'	4FT STR + (3) 8FT INT + 5FT FILLER	33' - 0" (396")	34' - 2" (410")
35'	4FT STR + (3) 8FT INT + 6FT FILLER	34' - 0" (408")	35' - 2" (422")
36'	4FT STR + (3) 8FT INT + 7FT FILLER	35' - 0" (420")	36' - 2" (434")
37'	8FT STR + (3) 8FT INT + 4FT FILLER	36' - 0" (432")	37' - 2" (446")
38'	8FT STR + (3) 8FT INT + 5FT FILLER	37' - 0" (444")	38' - 2" (458")
39'	8FT STR + (3) 8FT INT + 6FT FILLER	38' - 0" (456")	39' - 2" (470")
40'	8FT STR + (3) 8FT INT + 7FT FILLER	39' - 0" (468")	40' - 2" (482")
41'	4FT STR + (4) 8FT INT + 4FT FILLER	40' - 0" (480")	41' - 2" (494")
42'	4FT STR + (4) 8FT INT + 5FT FILLER	41' - 0" (492")	42' - 2" (506")
43'	4FT STR + (4) 8FT INT + 6FT FILLER	42' - 0" (504")	43' - 2" (518")
44'	4FT STR + (4) 8FT INT + 7FT FILLER	43' - 0" (516")	44' - 2" (530")
45'	8FT STR + (4) 8FT INT + 4FT FILLER	44' - 0" (528")	45' - 2" (542")
46'	8FT STR + (4) 8FT INT + 5FT FILLER	45' - 0" (540")	46' - 2" (554")
47'	8FT STR + (4) 8FT INT + 6FT FILLER	46' - 0" (552")	47' - 2" (566")
48'	8FT STR + (4) 8FT INT + 7FT FILLER	47' - 0" (564")	48' - 2" (578")
49'	4FT STR + (5) 8FT INT + 4FT FILLER	48' - 0" (576")	49' - 2" (590")
50'	4FT STR + (5) 8FT INT + 5FT FILLER	49' - 0" (588")	50' - 2" (602")



FILLER FIXTURES

1FR (REMOTE DRIVER):

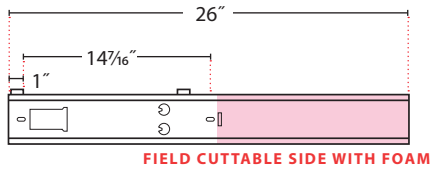

2F:

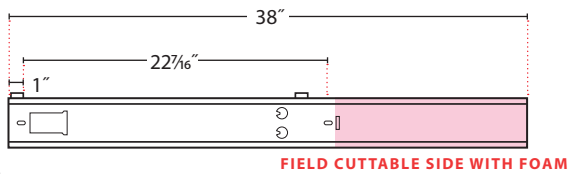

3F:

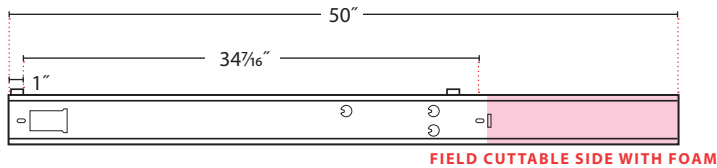

4F:

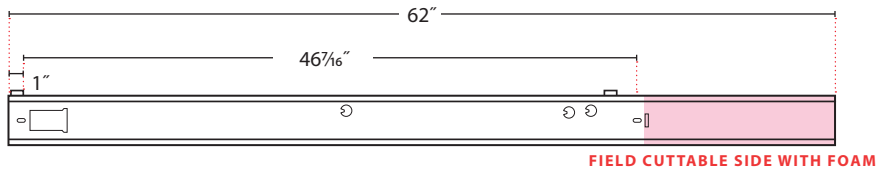

5F:

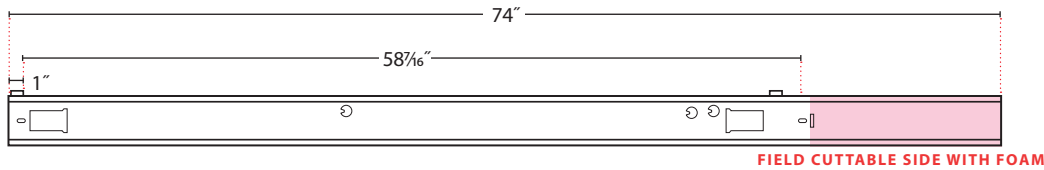

6F:

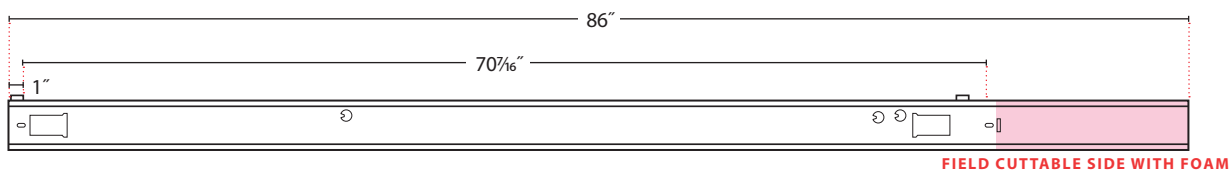

7F:

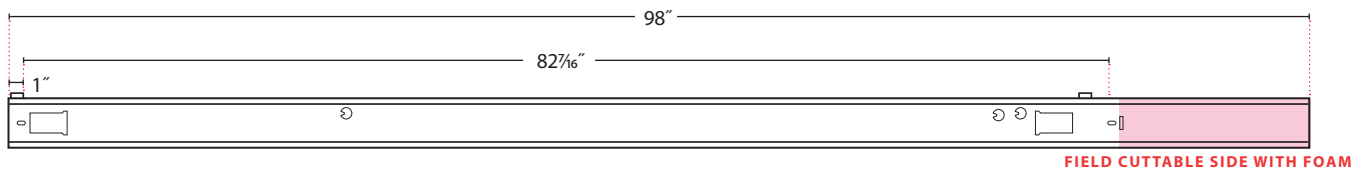

- Telescoping 2' – 8' fixtures. Fixtures adjust in length: 2' to 3', 4' to 5', 7' to 8', etc.
- Looks like a custom length fixture:
7' 8" = one field-adjusted fixture, no trim seams (seamless lens).
- Optical performance identical to standard fixtures.
- Much lower cost for wall-to-wall installs (one less fixture).
- Way easier installs, one cut, no assembly, installs like a standard fixture.



FILLER FIXTURE VIDEO

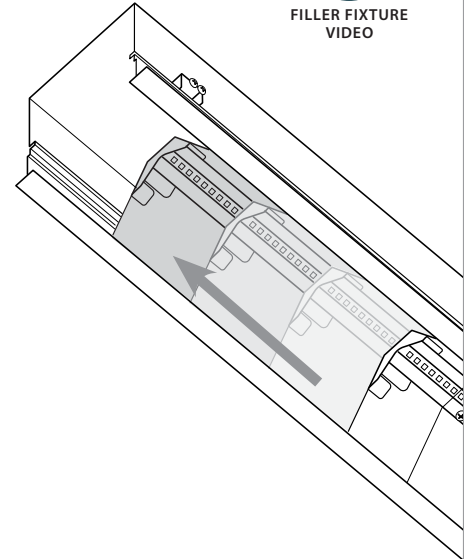

 POWER ACCESS PLATE  1/4-20 MOUNTING HOLES



Medium Wall Graze (MGZ)

Wall grazing performance often better just off a wall.

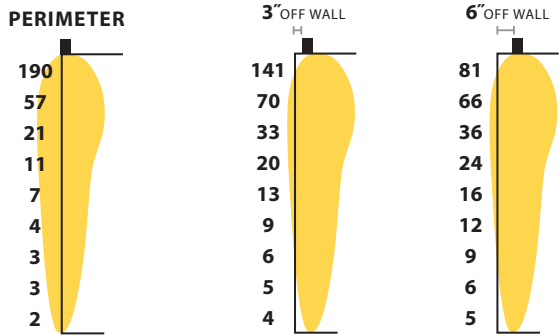

See BionicPro recessed linear specs

Perimeter Fill (PFL)

Wash a corridor in light from one side of the perimeter. Our Perimeter Fill is ideal for hospital corridors where a 50 fc average is needed.

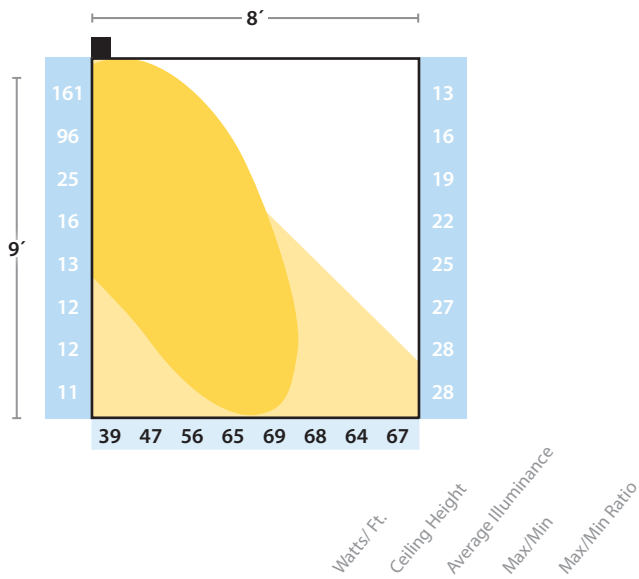

High Output 1225 lumens/ft	1	10'	64 fc	70/57	1.2
-------------------------------------	---	-----	-------	-------	-----



WIRING DIAGRAMS
SPEC



PRUDENTIAL LTG.

PRULITE.COM 213.746.0360

Lumen Outputs:

	BLUHUE, TUHUE, TUHUE2, AMBERHUE			
DIRECT:	LO	MO	SO	HO*
SAL Lm/Ft	205	385	550	715
PFL Lm/Ft	215	395	565	730
LGP Lm/Ft	225	405	580	750
W/Ft	3.8	5.6	7.8	10.5

** TU2 + AMB NOT AVAILABLE HO / CHROMAHUE ONLY AVAILABLE ON HO



Prudential Lighting's **TuHue** Tunable White provides warm to cool white light simulating sunlight. Controlling the light source color temperature offers differing design aesthetics with potential benefits via circadian rhythm support. Blue light for alertness while warm light conveys tranquility.

- 2700K-6500K or 2200K-5000K.
- Adjust the color temperate and brightness separately.
- Simulates warm to cool to warm transition of sunlight.

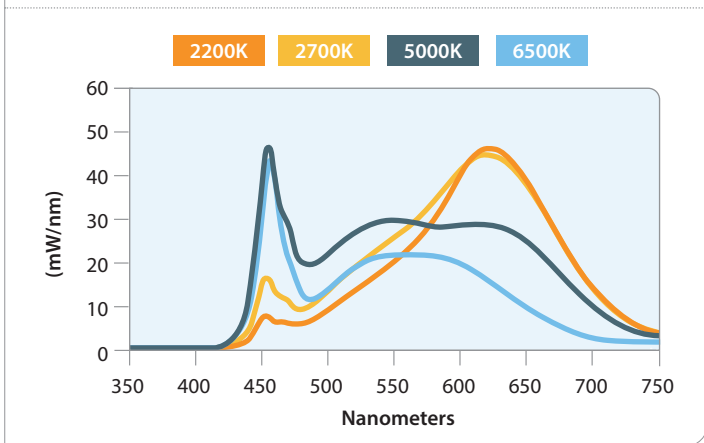
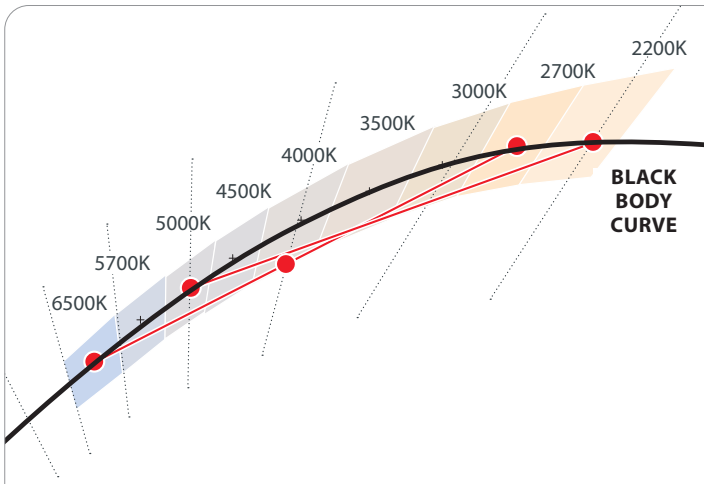

BluHue BIOS SkyBlue™ circadian LED lighting brings the benefits of blue skies inside. Newly discovered blue-sky receptors in our eyes drive improved daytime alertness, mood, brain function, and strengthens circadian rhythms leading to overall better health and well-being.

- Circadian rhythms play an integral role in physical and mental health.
- BluHue BIOS SkyBlue pinpoints peak 490nm sensitivity to provide the most benefit from an electric light source.
- At night, simply dim the lights to remove SkyBlue™ wavelengths (specify "Blu_D" to dim Cyan SkyBlue spike separately [night mode]).

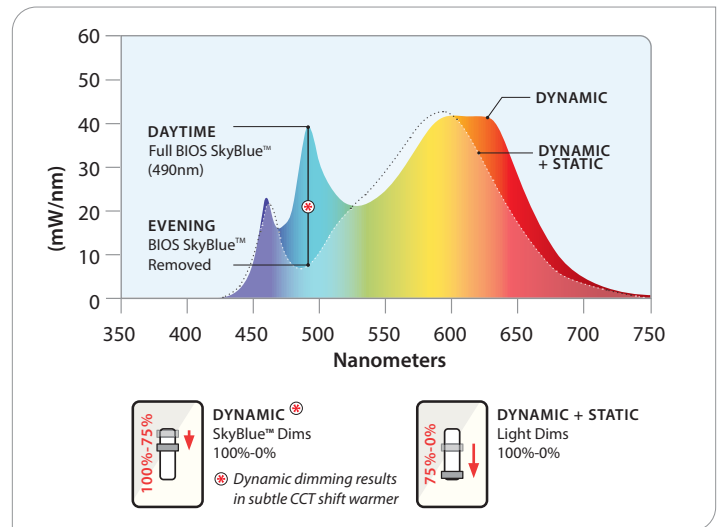

AmberHue is Prudential Lighting's Warm Dim offering. It transitions bright white light to warm amber light as brightness is dimmed, reflecting sunlight's transitioning from intense blue midday light to a dimmed golden hue near sunset, also reminiscent of soft glowing candlelight.

- Warm Dim 2200K-5000K.
- Color temperature warms as the luminaire is dimmed.
- Calm, relaxing mood communicated – hospitality, residential feel.

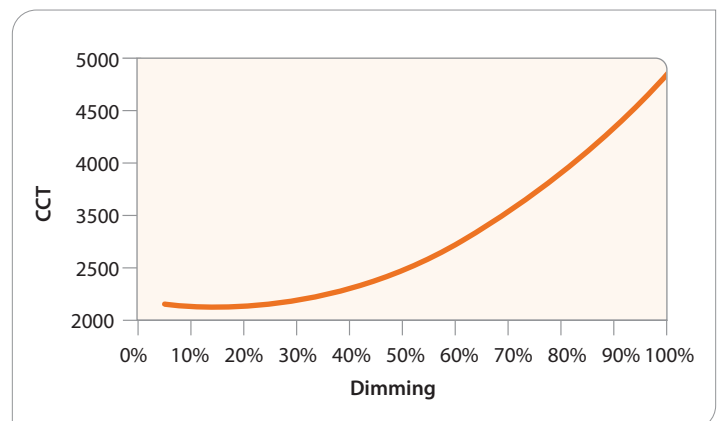



ChromaHue offers a vibrant full gamut of colors for seemingly endless architectural interior applications. Rich color-changing light offers tremendous design flexibility while white light can be achieved with the White chip, or mixing of Red, Green and Blue light. No longer just for the entertainment industry, ChromaHue can be intermixed on BionicPro luminaires for mood-creating indirect illumination combined with static white direct light.

- RGBW LED array (Red, Green, Blue, White) with full spectrum color and white light on the black body curve.
- Four-channel control, DMX drivers.
- Any color point within the triangle can be reached by setting the proper output levels for each individual red, green, blue and white channels.
- Standard DMX is one zone with one XLR drop at start, one XLR return at the end.

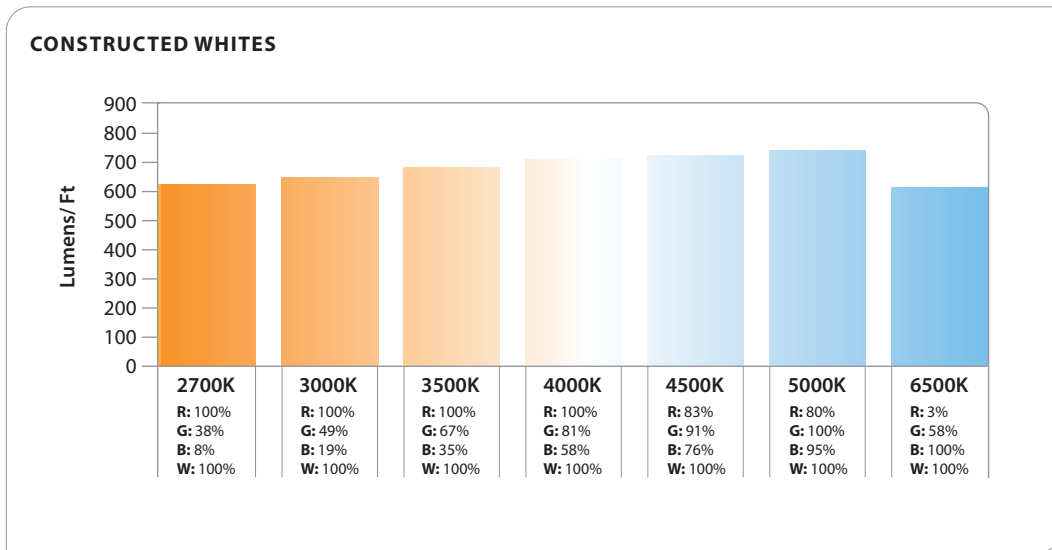
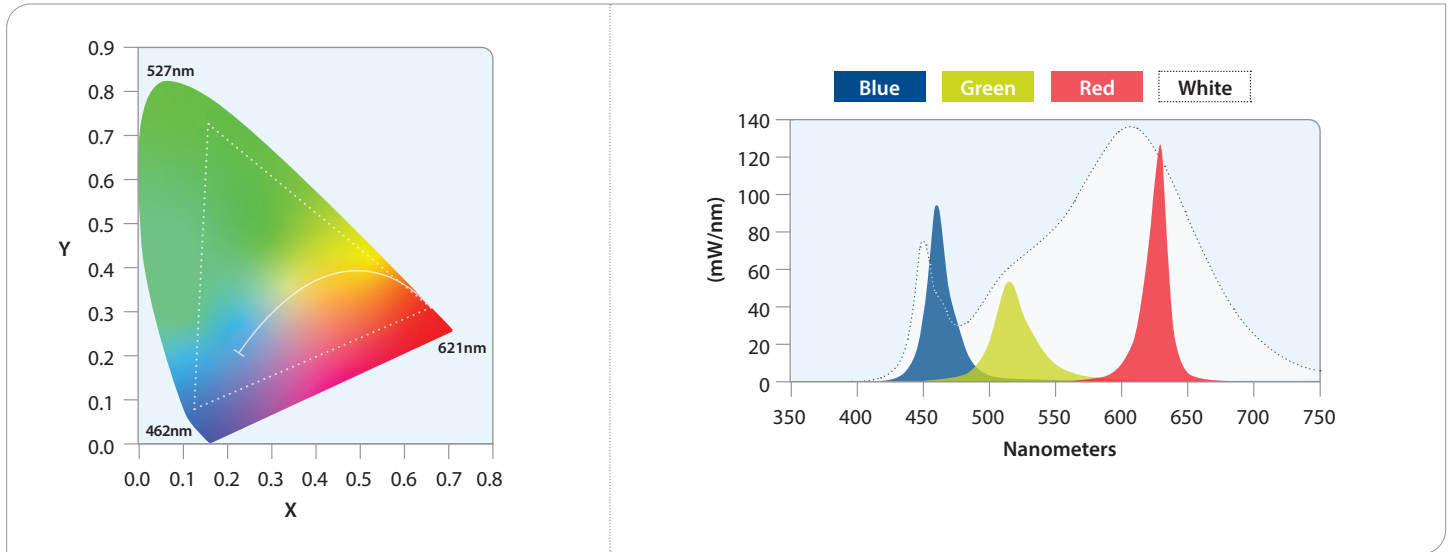



LM79 & TM30 DATA:

	MEASURED CCT	MEASURED LUMENS	CRI	R9	DuV	SPD	TM30 — COLOR VECTOR	TM30 — COLOR DISTORTION
LED27	2680	80%	93	58	0.001		89 Rf	97 Rg
LED3	3042	95%	82	6	0.001		81 Rf	92 Rg
LED3-90	3016	85%	93	61	0.000		88 Rf	96 Rg
LED35	3482	100%	82	3	0.002		81 Rf	92 Rg
LED35-90	3417	85%	93	67	0.000		88 Rf	96 Rg
LED4	3952	102%	82	4	0.003		81 Rf	92 Rg
LED4-90	3882	85%	92	67	0.003		87 Rf	96 Rg
LED5-90	4889	85%	94	84	0.002		86 Rf	95 Rg











LM79 & TM30 DATA:

		MEASURED CCT	MEASURED LUMENS	CRI	R9	LED27	SPD	TM30 — COLOR VECTOR
BH3S&D	bioS 3000K	2779	2758	87	81	0.003		
	BH3D SKY BLUE DIMMED	2715	2425	82	3	0.002		
BH35S&D	bioS 3500K	3245	2919	85	87	0.003		
	BH35D SKY BLUE DIMMED	3061	2502	83	7	0.001		
BH4&D	bioS 4000K	3624	2993	85	86	0.004		
	BH4D SKY BLUE DIMMED	3388	2585	83	5	0.002		
TH	LED27	2684	2456	92	57	0.0001		
	LED65	6061	3292	82	-1	0.006		
TH2	LED22	2209	2112	92	52	0.0005		
	LED50	4796	2789	93	77	0.004		
CH	2700K	2632	2469	82	50	0.003		
	3500K	3388	2585	83	5	0.002		
	4000K	3977	2682	83	29	0.003		
	5000K	5233	2823	84	21	0.003		



SENSORS

				
<p>205: Wattstopper</p>	<p>LVOC: Lutron Occupancy /Daylight Sensor</p>	<p>LVRF: Lutron Vive Control Node</p>	<p>NXSMP: Hubbell Occupancy /Daylight Sensor</p>	<p>ATHENA</p>
<p>Low voltage PIR fixture integrated occupancy sensor.</p>	<p>Measures light in the space (daylighting) while detecting people moving within an area using passive infrared to determine occupancy.</p> <p>Controls the lights to balance the light level in the space, combining convenience, exceptional energy savings, and ease of installation.</p>	<p>Provides wireless control of the fixture when neither occupancy nor daylight sensing is needed.</p>	<p>Hubbell Integrated/embedded networked lighting control, luminaire-level lighting control, LLLC.</p> <p>PIR motion sensor for automatic On/Off control.</p> <p>Integrated daylight sensor for daylight harvesting and/or lumen maintenance.</p> <p>Bluetooth radio provides wireless control of luminaire.</p> <p>Simple plug-in connection to NX Fixture Modules.</p> <p>Wireless Internet.</p>	<p>The Athena wireless node is a radio frequency (RF) device that enables simple, digital control of individual light fixtures in an Athena control system.</p> <p>The small size and compatibility with a wide variety of drivers allow for seamless integration with common commercial lighting fixtures from any manufacturer.</p> <p>Requires drivers with auxiliary power, consult factory for lead times</p>

			
<p>NLT-AIR-rIO: Daylight+Occ</p>	<p>NLT-AIR-ADCX: Daylight+(PIR Acoustic) Occ</p>	<p>NLT-WIRED-nIO: Daylight+Occ</p>	<p>NLT-WIRED-ADCX: Daylight+(PIR Acoustic) Occ</p>
<p>The rIO is a fixture embedded low voltage wireless nLight AIR device capable of individual fixture control and analog or digital dimming. This smart device results in the luminaire being “nLight AIR-enabled” — making it an addressable nLight AIR device. It uses a 900MHz radio to communicate with other nLight AIR devices, such as occupancy sensors, photocells, wall switches, powerpacks and other nLight AIR-enabled luminaires. This allows for advanced operation and design flexibility ranging from stand-alone rooms to building and campus-wide networks.</p>	<p>The nLight® AIR rES7 sensor is an in-fixture, low voltage, digital sensor providing embedded wireless lighting control, analog or digital dimming, occupancy detection and daylight harvesting capabilities.</p> <p>The rES7 is designed for mounting heights up to 20 ft in indoor luminaires. The rES7 sensor provides Passive Infrared (PIR) occupancy detection over a 15-20 ft (4.57 - 6.10 m) radial coverage pattern and photocell light level detection in one compact low profile design with optional Dual Technology, which adds Microphonics™ to PIR detection. The rES7 sensor is ideal for occupancy and daylighting control in suspended or recessed luminaires.</p>	<p>nLight digital nIO modules are low voltage control devices that enable digital control of LEDcode enabled eldoLED LED drivers. Through eldoLED's bi-directional 2-wire interface, these modules deliver natural, flicker-free high performance dimming while eliminating common issues related to 0-10 VDC alternatives. The modules also enable the eldoLED LED Drivers to be addressable, as well as capable of digitally communicating with other nLight controls such as occupancy sensors, photocells, and WallPods. This allows for advanced operation and design flexibility ranging from stand-alone rooms to building and campus-wide networks.</p>	<p>The nES7 is a small passive infrared occupancy sensor designed to be easily embedded into luminaires. This sensor provides excellent line of sight 360° PIR detection of small motion and walking motion. The nES7 is ideal for small rooms without obstructions or areas with primarily walking motion (e.g. corridors, library stacks). Additionally, an optional integrated photocell enables daylight harvesting control as well. Typically one or more nES7 sensors are paired with an nLight controller within an nLight enabled luminaire.</p> <p>For rooms like classrooms and private offices or any space with obstructions, the nES PDT 7 dual technology sensor is recommended.</p>