

DIRECT:	LO	MO	SO	HO
SAL Lm/Ft	485	715	990	1245
BTW Lm/Ft	500	740	1025	1300
WWF Lm/Ft	500	750	1025	1325
WWG / PFL Lm/Ft	500	750	1025	1300
NGZ Lm/Ft	550	800	1125	1500
MGZ Lm/Ft	500	750	1025	1300
WGZ Lm/Ft	550	800	1125	1500
LGP Lm/Ft	500	750	1025	—
W/Ft	3.8	5.6	7.8	10.5
INDIRECT:	LO	MO	SO	HO
SYM Lm/Ft	650	875	1150	1425
HCW Lm/Ft	335	500	680	850
MCW Lm/Ft	400	550	750	1000
SCW Lm/Ft	575	875	1170	1450
SACW Lm/Ft	500	750	1000	1200
W/Ft	3.8	5.6	7.8	10.5
DIRECT / INDIRECT:	LO	MO	SO	HO
W/Ft	7.6	11.2	15.6	21

SMART SPECS

**TUNABLE WHITE**

Tu Hue  
Amber Hue  
Blu Hue  
Chroma Hue

**NEW LAMINATE FINISH OPTIONS**  
SEE PAGE 3 FOR ALL OPTIONS

Lumen output may vary +/- 5%  
Light Loss Factor (LLF) for CCTs other than 3500K:  
4000K +2%, 3000K -5%, 2700K -20%  
90 CRI -15% (3K, 3500K, 4K & 5K  
ADC -2% LLF  
Louver LLF 30% White, 50% Silver, 70% Black

SOCIAL MEDIA KIT SEAMLESS Declare. DLC UGR15.5 WELL Building Standard LED WARRANTY 5 YEARS Made in the USA

SE-RIES	LENS POS.	LED COLOR	OUT-PUT	LENGTH	COLOR / LAMINATE	LAM. CAN-OPY COLOR	LOUVER COLOR	DISTRIBUTION	UP OP-TIONS	CIRCU-ITING	MOUNTING	CEILING TYPE	DRIVERS	OPTIONS & SENSORS
BPROS-LIN														
BionicPro 5" Linear	FLSH Flush Lens LVR 1/2" Regress with Louver REG.5 1/2" Regress IND Indirect Only (Select NW No Down-light)	LED27 2700K (90CRI) LED3 3000K LED35 3500K LED4 4000K LED3-90 3000K (90CRI) LED35-90 3500K (90CRI) LED4-90 4000K (90CRI) LED5-90 5000K (90CRI) PRUHEUES: STATIC: BLU3S BLU3SS BLU4S DYNAMIC: BLU3D* BLU3SD* BLU4D* * Dynamic BIOS, SkyBlue spike can be dimmed, CCT warns slightly TU TuHue 2700-6500K Tunable White TU2** TuHue 2200-5000K Tunable White AMB** AmberHue Warm Dim 2200K-5000K ** NAHO CHR ChromaHue RGBW (DMX at HO only) DOWN & UP CCT IF DIFFERENT	LO Low MO Medium SO Standard HO High PROG Programmable Light Output (Specify desired lm/ft or w/ft) SRL Sym-metric Row Length	2' 3' 4' 5' 6' 7' 8' R (Row Length, 1" increments. Consult factory for custom lengths) NOTE: Individual fixtures are NOT intended for row mounting	TMW Textured Matte White (Standard) YGW Gloss White Y__ Pre-mium Color CC__ Custom Color LUXE METAL-LICS: YBZ Bronze YCP Copper YGN Gold YNG Nugget NOTE: For LUXE finishes, Stem and Canopy are White (TMW) unless specified otherwise. LAMINATE FINISHES (SPECIFY CAN-OPY COLOR IN NEXT COLUMN =>) LOK Vara Oak LEW Evreux Walnut LOG Oxidized Gold LOB Oxidized Black L__ Special Order Laminated (EXTENDED LEAD TIMES) NOTE: For Laminated finishes, Stem and Canopy are White (TMW) unless specified otherwise.	(SKIP THIS COLUMN IF LAMINATE FINISH IS NOT SELECTED) TMW Textured Matte White (Standard) YGW Gloss White Y__ Premium Color CC__ Custom Color LUXE METAL-LICS: YBZ Bronze YCP Copper YGN Gold YNG Nugget LUXE METAL-LICS: YBZ Bronze YCP Copper YGN Gold YNG Nugget NOTE: For LUXE finishes, Stem and Canopy are White (TMW) unless specified otherwise.	TMW Textured Matte White (Standard) YGW Gloss White Y__ Premium Color CC__ Custom Color LUXE METAL-LICS: YBZ Bronze YCP Copper YGN Gold YNG Nugget NGZ Narrow Wall MGZ Medium Wall WGZ Wide Wall LGP Low Glare Prismatic (NA HO)	CHOOSE DOWN -AND- UP DOWN: NW No Direct SAL Satin Lens BTW Batwing WWF Flat Wall Wash WWG Focal Glow Wall Wash PFL Perimeter Room Fill NGZ Narrow Wall MGZ Medium Wall WGZ Wide Wall LGP Low Glare Prismatic (NA HO) UP: NU No In-direct SYM Sym-metric (Frosted ADC, Standard) HCW Hard Ceiling Wash MCW Medium Ceiling Wash SCW Soft Ceiling Wash SACW Soft Asym-metric Ceiling Wash	TG Top Glow ADC Acrylic Dust Cover (Clear) Standard for SYM (Frosted) TGADC Top Glow with Acrylic Dust Cover UP OP-TIONS AVAIL-ABLE WITH ANY UP DISTRI-BUTION	SC Single Circuit (Down & Up will dim together) DC Dual Circuit (Needed if dimming Down separately from Up) VOLT-AGE UNV (120-277) 347 (Emergency battery requires remote driver box)	(SPECIFY CEILING TYPE IN NEXT COLUMN =>) CA48", 96" or 144" Aircraft Cable (Adjust-able) SURF Surface Mount (Direct only) RSC Rigid Stem Center SSC Swivel Stem Center (~45° of rotation) (SPECIFY MOUNTING LOCATION IN NEXT COLUMN =>) WMC (Chan-nel) .75" Tall Continuous Channel WMC2 (Channel) 2" Tall Continuous Channel WMU (Bracket) .5" Tall Bracket WMU1 (Bracket) 1" Tall Bracket WMU2 (Bracket) 2" Tall Bracket WM Direct to Wall WBx.x Wall Bracket (2"-6" in .5" increments, 3" standard if not specified)	CEILING TYPE: X1 T-Bar X3 Hard Ceiling X6 Slot Grid MOUNT-ING LOCA-TION: WALL (For Wall or Mullion Mount) SUR Ceiling WALL	ND Non-Dimming DM01 0-10v, 1% Dimming (Standard) LDE1 Hi-lume 1% EcoSystem LED (Soft fade on, fade-to-black dimming) ECO 1% 0-10v, EldoLED (Logarithmic dimming std) ECDA 1% DALI, EldoLED (Logarithmic dimming std) nLight-Air Acuity nLight Drivers (ECDA driver ONLY) nLight-Wired Acuity nLight Drivers (ECO driver ONLY) SOLO 0.1% 0-10v, EldoLED (Dim-to-dark, Logarithmic dimming std) SODA 0.1% DALI, EldoLED (Dim-to-dark, Logarithmic dimming std) STEP Signify Advance Step Dimming 2WIRE ELV/For-ward/Reverse Phase Driver PRUHEUES: E10V 2 Channel Color Control EDALI 2 Channel Color Control EDMX Chroma-Hue or Static White	EMHE CA T20 Emergency Battery (1250 Delivered lumens; CA Title 20 Compliant, 2' remote) ETS-DR Iota ETS-DR Emergency Transfer Switch EMC Emergency Circuiting FTR Feather WTW Asym-metric on Perpendicular Wall (NA HO or LGP) EBCP1G /2G Single / Dual Gang (Electrical Box Cover Plate/ Mud Ring) COS Custom On-Center Spacing for Wall/Surface Brackets SENSORS: (NA w/EDMX) 205 WattStopper PIR Occupancy 205-ON/OFF 205-STEP: Dim to 50% 205-DM: Dim to 1% (NA with DALI) ATHENA Lutron RF (Dim-to-Off Standard) LVOC** Lutron Vive (Occ & RF) LVRF** Lutron Vive (RF Only) ** Requires Lutron driver NXSMP Hubblell (Occ) rES7 Daylight+(PIR Acoustic) (Occ) (nLight-Air) Part Number: rES7-PDT-180D-G2 nES7 Daylight+(PIR Acoustic) (Occ) LUX Philips DLR CORNERS: C2-60 Lit 60° C2-90 Lit 90° C2-120 Lit 120° C2-135 Lit 135° C3T Lit 90° 3-Way: T C3Y Lit 120° 3-Way: Y C4T Lit 90° 4-Way: + C4X Lit 45°-135° 4-Way: X C8I Lit Inside 2-Plane C8O Lit Outside 2-Plane 90° LOUVERS AVAILABLE (CONSULT FACTORY FOR OTHER ANGLES) LRT Linear to Recessed Transition (Straight rows only) DWNLT Downlights

# BionicPro5 | Linear Downlights



PRUDENTIAL LTG.

PRULITE.COM 213.746.0360



**Want Downlights without a lens?**

Specify 'NW' No Direct + desired indirect  
+ Downlight option in last column  
NW-\_\_\_\_-DWNLT

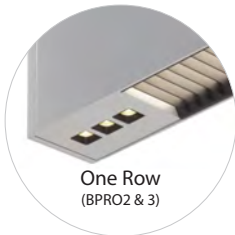

One Row  
(BPRO2 & 3)



Two Rows  
(BPRO4 & 5)

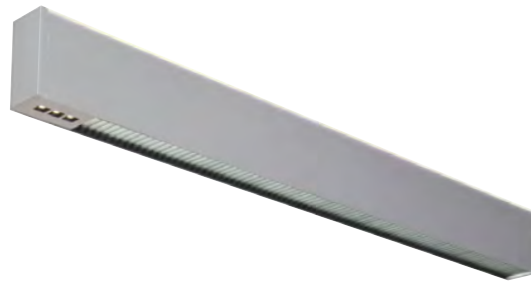

**LEFT**  
(Start) Placement  
(BPRO2 Linear shown with Louver)



**MID**  
Middle of Row Placement  
(BPRO4 Recessed shown with Flush Lens)

		NRW 20°	MED 35°	WDE 55°
<b>1 ROW</b>	Lm	445	425	350
	W	9	9	9
<b>2 ROWS</b>	Lm	500	465	425
	W	8.7	8.7	8.7

NRW 20°				MED 35°				WDE 55°			
DISTANCE	FOOTCANDLES		BEAM	DISTANCE	FOOTCANDLES		BEAM	DISTANCE	FOOTCANDLES		BEAM
	1 ROW	2 ROWS			1 ROW	2 ROWS			1 ROW	2 ROWS	
3'	251	281.5	12.7"	3'	138	144	22.8"	3'	80	67	37.5"
4'	104.7	116.7	17.0"	4'	67.3	70	30.3"	4'	40	35.7	50.0"
5'	82.3	91.7	21.1"	5'	47	49.2	37.8"	5'	27	23.7	62.5"
6'	52.9	58.5	25.4"	6'	31.5	32.7	45.4"	6'	18	16.1	75.0"
7'	29.5	32.7	29.6"	7'	17.6	18.4	53.0"	7'	10	9.1	87.5"
8'	27.6	30.53	33.8"	8'	16.05	16.9	60.5"	8'	9	8.15	100.0"
9'	25.7	28.36	38.1"	9'	14.5	15.4	68"	9'	9	7.2	112.4"

SERIES	QUANTITY	LOCATION	CCT	DISTRIBUTION	COLOR	VOLT-AGE	DRIVERS
DWN-LT							
Down-light	<b>SPECIFY DOWNLIGHT QUANTITY PER FIXTURE/ROW</b> Maximum One (1) Downlight Every 4' 16' Row = 4 Downlights 30' Row = 7 Downlights	MID One Downlight in Middle of Fixture LT One Downlight on Left (Start) RT One Downlight on Right (End) LT-RT Two Downlights on Ends LT-MID Two Downlights on Left and Middle MID-RT Two Downlights on Middle and End MOD Downlight Location(s) per Specs	LED3-90 3000K-90CRI (Standard) LED35-90 3500K-90CRI LED4-90 4000K-90CRI  NOTES: - NA 2700K, 5000K - Only 1 Output Offered	NRW Narrow 20° Beam MED Medium 35° Beam WDE Wide 55° Beam	TMW Textured Matte White (Standard) YGW Gloss White Y_ Premium Color CC Custom Color  <b>LUXE METALLICS:</b> YBZ Bronze YCP Copper Penny YGN Gold Nugget	UNV (120-277) 347	DM01 0-10v, 1% Dimming (Standard) LDE1 Hi-lume 1% EcoSystem LED (Soft fade on, fade-to-black dimming) ECO 1% 0-10v, EldoLED (Logarithmic dimming std) ECDA 1% DALI, EldoLED (Logarithmic dimming std) SOLO 0.1% 0-10v, EldoLED (Dim-to-dark, Logarithmic dimming std) SODA 0.1% DALI, EldoLED (Dim-to-dark, Logarithmic dimming std)



## FLSH:

### SATIN LENS

#### MEDIUM OUTPUT:

##### BPRO5-LIN-FLSH-LED35-MO-SAL

2872 Delivered Lumens  
23 Watts  
126 lm/w  
1.24 Spacing Criteria

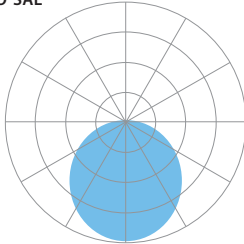

#### Zonal Lumen Summary:

0-90 = 100%

1033

Vertical Angle	0°	25°	45°	65°	90°
0°	1033	1033	1033	1033	1033
5°	1024	1025	1022	1027	1028
15°	974	976	977	984	987
25°	884	887	891	903	909
35°	768	771	777	792	800
45°	634	635	642	656	668
55°	486	487	494	507	520
65°	332	332	340	351	363
75°	173	175	186	196	207
85°	27	28	35	47	57
90°	0	0	0	0	0

### BATWING

## UGR15.5

WELL Building Standard

#### MEDIUM OUTPUT:

##### BPRO5-LIN-FLSH-LED35-MO-BTW

2975 Delivered Lumens  
23 Watts  
131 lm/w  
1.94 Spacing Criteria

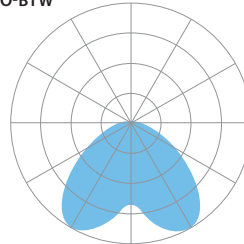

#### Zonal Lumen Summary:

0-90 = 100%

1143

Vertical Angle	0°	25°	45°	65°	90°
0°	716	716	716	716	716
5°	774	768	744	725	709
15°	1008	972	861	731	655
25°	1143	1104	953	710	568
35°	1120	1092	955	651	475
45°	944	941	854	553	394
55°	637	661	654	429	321
65°	360	380	405	300	248
75°	170	179	199	176	162
85°	33	34	42	52	57
90°	0	0	0	0	0

### LOW GLARE PRISMATIC

## UGR15.5

WELL Building Standard

#### STANDARD OUTPUT:

##### BPRO5-LED35-SO-LGP

3722 Delivered Lumens  
32 Watts  
117 lm/w  
3500 CCT

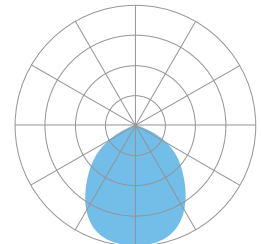

#### Zonal Lumen Summary:

0-90 = 100%

1855

Vertical Angle	0°	25°	45°	65°	90°
0°	1855	1855	1855	1855	1855
5°	1849	1844	1836	1845	1848
15°	1767	1756	1740	1738	1735
25°	1597	1580	1549	1525	1510
35°	1350	1328	1272	1212	1175
45°	1048	1012	897	766	718
55°	688	609	459	380	351
65°	351	305	247	216	204
75°	140	138	103	96	92
85°	32	41	30	27	28
90°	0	0	0	0	0



## NW - UP:

### HARD CEILING WASH

**STANDARD OUTPUT:**  
**BPRO5-LED35-SO-NW-SCW**  
 2504 Delivered Lumens  
 33 Watts  
 76 lm/w  
 3500 CCT

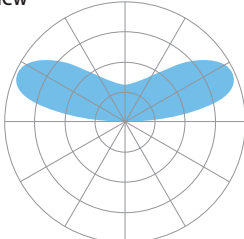

**Zonal Lumen Summary:**  
 90-180 = 100%

1044

Vertical Angle	0°	22.5°	45°	67.5°	90°
90°	0	0	0	0	0
95°	208	260	243	148	28
105°	924	832	548	261	96
115°	1044	915	600	299	168
125°	922	806	554	323	226
135°	716	639	478	330	268
145°	538	497	410	330	294
155°	421	403	364	328	310
165°	356	350	337	326	319
175°	327	326	324	324	324
180°	322	322	322	322	322

### SYMMETRIC

**STANDARD OUTPUT:**  
**BPRO5-LED35-SO-NW-SYM-ADC**  
 4618 Delivered Lumens  
 33 Watts  
 141 lm/w  
 3500 CCT

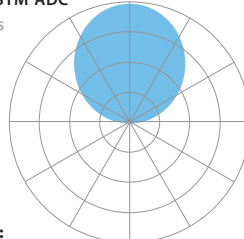

**Zonal Lumen Summary:**  
 90-180 = 100%

1834

Vertical Angle	0°	22.5°	45°	67.5°	90°
90°	0	0	0	0	0
95°	74	75	74	73	74
105°	274	270	270	266	269
115°	510	505	506	507	514
125°	775	777	779	783	793
135°	1061	1063	1064	1074	1084
145°	1336	1338	1337	1349	1361
155°	1565	1567	1564	1576	1592
165°	1723	1725	1720	1734	1752
175°	1803	1805	1799	1813	1834
180°	1819	1819	1819	1819	1819

### MEDIUM CEILING WASH

**STANDARD OUTPUT:**  
**BIOPRO-LIN-SO-MCW**  
 3115 Delivered Lumens  
 32 Watts  
 97 lm/w  
 3500 CCT

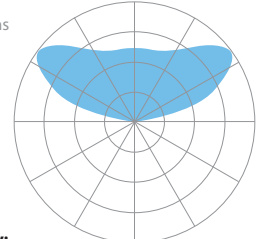

**Zonal Lumen Summary:**  
 90-180 = 100%

1138

Vertical Angle	0°	22.5°	45°	67.5°	90°
90°	0	0	0	0	0
95°	41	45	57	33	1
105°	464	475	344	146	92
115°	852	787	495	539	204
125°	1060	916	573	256	296
135°	973	843	601	469	442
145°	811	739	1138	544	530
155°	709	683	619	600	598
165°	667	657	642	635	640
175°	659	657	655	653	656
180°	664	664	664	664	664

### SOFT CEILING WASH

**STANDARD OUTPUT:**  
**BPRO4-LED35-SO-NW-SCW**  
 4639 Delivered Lumens  
 33 Watts  
 143 lm/w  
 3500 CCT

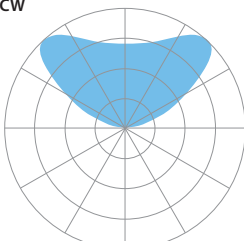

**Zonal Lumen Summary:**  
 90-180 = 100%

1584

Vertical Angle	0°	22.5°	45°	67.5°	90°
90°	0	0	0	0	0
95°	102	123	161	136	48
105°	367	409	463	344	198
115°	755	804	824	539	369
125°	1270	1283	1117	701	539
135°	1584	1492	1179	823	700
145°	1484	1381	1138	921	851
155°	1279	1220	1102	1005	978
165°	1149	1130	1094	1074	1073
175°	1114	1111	1106	1114	1123
180°	1117	1117	1117	1117	1117

### SOFT ASYMMETRIC CEILING WASH

**STANDARD OUTPUT:**  
**BPRO5-LIN-SO-SACW**  
 4073 Delivered Lumens  
 33 Watts  
 125 lm/w  
 3500 CCT

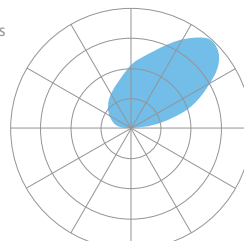

**Zonal Lumen Summary:**  
 90-180 = 100%

2106

Vertical Angle	0°	22.5°	45°	67.5°	90°
90°	0	0	0	0	0
95°	341	366	345	222	46
105°	939	946	853	503	174
115°	1475	1458	1268	697	320
125°	1906	1856	1504	848	463
135°	2106	1962	1499	946	599
145°	1906	1745	1373	1011	724
155°	1544	1443	1245	1046	828
165°	1268	1230	1149	1042	904
175°	1069	1048	1018	985	945
180°	936	936	936	936	936



## FLSH:

### FLAT WALL WASH

#### STANDARD OUTPUT:

BPRO5-LIN-FLSH-LED35-SO-4-WWF

2056 Delivered Lumens

15 Watts

136 lm/w

3500 CCT

Test

104359650LAX-005B

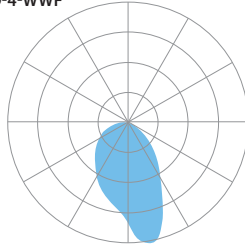

1340

**Zonal Lumen Summary:**  
0-90 = 100%

Vertical Angle	WALL SIDE					ROOM SIDE				
	0°	25°	45°	65°	90°	180°	202.5°	225°	247.5°	270°
90°	0	0	0	0	0	0	0	0	0	0
85°	26	29	30	30	28	33	29	24	25	28
75°	85	87	100	102	94	112	98	120	84	94
65°	148	157	196	212	185	172	162	161	163	185
55°	243	267	343	413	339	248	249	264	282	339
45°	416	461	577	686	513	358	365	388	412	513
35°	698	744	873	941	634	472	477	490	516	634
25°	1032	1082	1189	1046	711	553	557	568	596	711
15°	1340	1322	1205	971	764	623	626	634	668	764
5°	975	955	908	850	792	697	702	715	748	792
0°	794	794	794	794	794	794	794	794	794	794

### FOCAL GLOW WALL WASH / PERIMETER FILL

#### LOW OUTPUT:

BPRO5-FLSH-LED35-LO-4-WWG/PFL

2042 Delivered Lumens

15 Watts

135 lm/w

3500 CCT

Test

104464711LAX-011

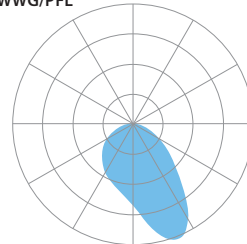

1256

**Zonal Lumen Summary:**  
0-90 = 100%

Vertical Angle	WALL SIDE					ROOM SIDE				
	0°	25°	45°	65°	90°	180°	202.5°	225°	247.5°	270°
90°	0	0	0	0	0	0	0	0	0	0
85°	27	27	30	32	31	31	27	24	25	28
75°	79	83	104	111	97	112	98	120	84	94
65°	151	163	225	232	167	172	162	161	163	185
55°	281	310	450	440	259	248	249	264	282	339
45°	550	613	811	662	373	358	365	388	412	513
35°	1042	1087	1078	764	491	472	477	490	516	634
25°	1256	1209	1024	798	607	553	557	568	596	711
15°	1019	993	906	808	698	623	626	634	668	764
5°	835	833	808	782	747	697	702	715	748	792
0°	754	754	754	754	754	754	754	754	754	754

### MEDIUM WALL GRAZER

#### LOW OUTPUT:

BPRO5-FLSH-LED35-LO-4-MGZ-DM01

2037 Delivered Lumens

15 Watts

135 lm/w

4000 CCT

Test

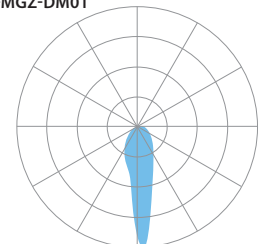

2296

**Zonal Lumen Summary:**  
0-90 = 100%

Vertical Angle	WALL SIDE					ROOM SIDE				
	0°	25°	45°	65°	90°	180°	202.5°	225°	247.5°	270°
90°	0	0	0	0	0	0	0	0	0	0
85°	52	53	32	27	28	28	29	24	25	28
75°	155	141	89	91	95	112	98	120	84	94
65°	217	181	145	181	189	172	162	161	163	185
55°	222	208	216	313	374	248	249	264	282	339
45°	259	264	301	480	714	358	365	388	412	513
35°	336	349	400	698	1226	472	477	490	516	634
25°	440	461	565	1082	1773	553	557	568	596	711
15°	713	788	1064	1748	2139	623	626	634	668	764
5°	1982	2053	2187	2332	2291	697	702	715	748	792
0°	2296	2296	2296	2296	2296	794	794	794	794	794



## REG.5:

### SATIN LENS

**STANDARD OUTPUT:**  
**BPRO5-LIN-REG.5-LED35-SO-SAL**  
 3784 Delivered Lumens  
 33 Watts  
 115 Lm/W  
 3500 CCT

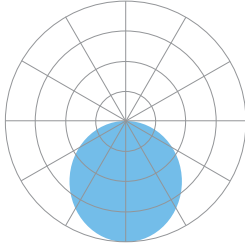

### MEDIUM WALL GRAZER

**STANDARD OUTPUT:**  
**BPRO5-LIN-REG.5-LED35-SO-4-MGZ**  
 3950 Delivered Lumens  
 31 Watts  
 127 Lm/W  
 3500 CCT  
 16° FWHM

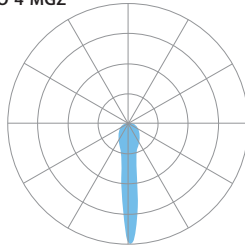

### PERIMETER FILL

**STANDARD OUTPUT:**  
**BPRO5-LIN-REG.5-LED35-SO-4-PFL**  
 3784 Delivered Lumens  
 33 Watts  
 115 Lm/W  
 3500 CCT

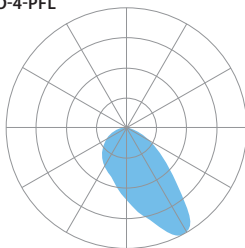

UPTO **127** LPW

REG.5:	LO	MO	SO	HO
<b>SAL</b> Lm/Ft	475	690	1000	1250
<b>BTW</b> Lm/Ft	500	750	1025	1300
<b>WWF</b> Lm/Ft	500	750	1025	1300
<b>WWG/PFL</b> Lm/Ft	500	750	1025	1300
<b>MGZ</b> Lm/Ft	500	750	1025	1300
W/Ft	4	6	8	10.5

LUMEN CHART AT 3500K-80 CRI

Consult factory for Louver IES: [marketing@prulite.com](mailto:marketing@prulite.com)

## LUMEN MAINTENANCE

- L70** — 200,000+ Hours
- L90** — 100,000+ Hours (LO, MO & SO)
- L90** — 60,000+ Hours (HO)

## LED SYSTEM

LED modules and drivers are field replaceable.

## PROG (OPTIONAL)

Programmable light output. Specify desired lumens or watts per linear foot.

## LABELS

CSA and ETL damp labeled and I.B.E.W. manufactured.

## ELECTRICAL

Must specify LED dimming controls. LED fixtures have constant current driver(s) with less than 20% THD when loaded to a minimum of 60%. Drivers sink a maximum of 6mA per driver. DM01 LED drivers are 0-10V dimmable and are compatible with most 0-10V wall slide dimmers and direct 0-10V analog signal dimmers. Max driver size 1.65" w x 1.25" h.

## CONSTRUCTION

- Housing** Extruded aluminum housing and side wall >25% PC recycled, 100% recyclable.
- Lens** Seamless lens up to 200'. Consult factory for longer lengths. Polymer, 100% recyclable.
- Weight** 3.5 lbs/ft

## MOUNTING

Surface mounted to walls or ceilings, wall spacer, wall bracket to wall, suspended by cable.

## WARRANTY

Single-source, 5 year limited warranty covers standard components and construction.

## FINISH COLORS

### STANDARD:



### PREMIUM:

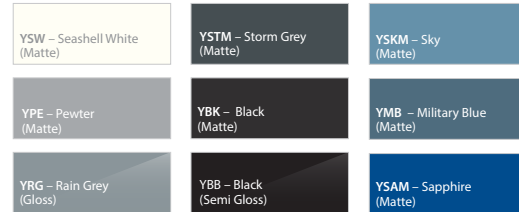

### LUXE METALLICS:



## LAMINATE FINISHES:

Choose from one of our Premium Colors with no set-up fee. For paint chip samples, please email: [info@prulite.com](mailto:info@prulite.com)

### STANDARD:

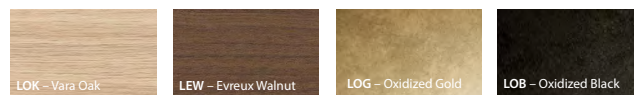

### SPECIAL ORDER (EXTENDED LEAD TIMES):

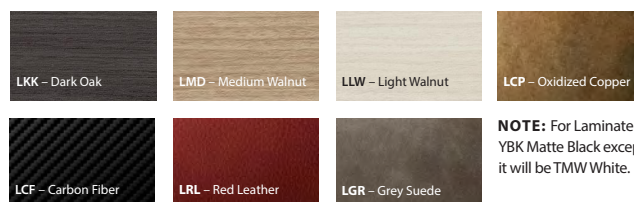

**NOTE:** For Laminate finishes Stem is YBK Matte Black except for LOK and LLW it will be TMW White.



CAST ALUMINUM END CAPS

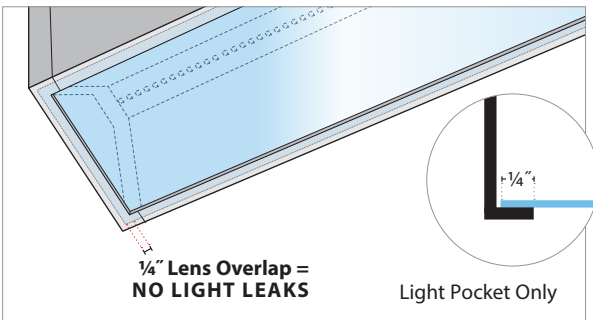

ADJOINING DETAILS

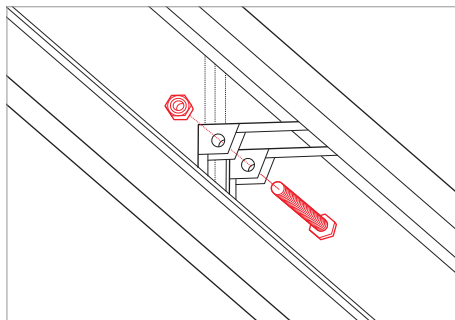

DISTRIBUTIONS

DOWN:

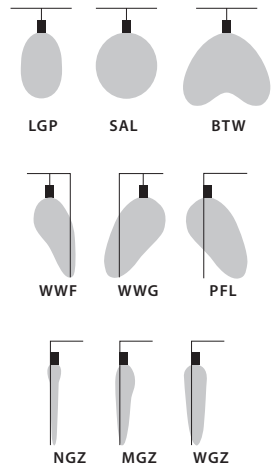

UP:

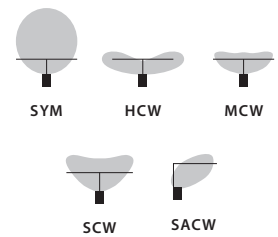

EBCP — ELECTRICAL BOX COVER PLATE

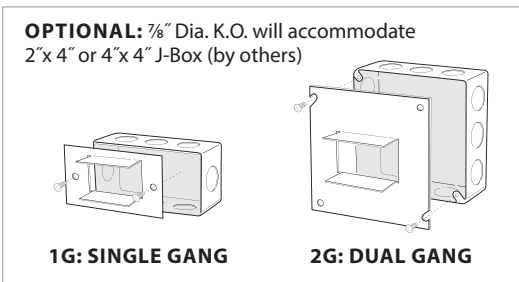

CANOPY DETAIL



WALL CROSS SECTIONS

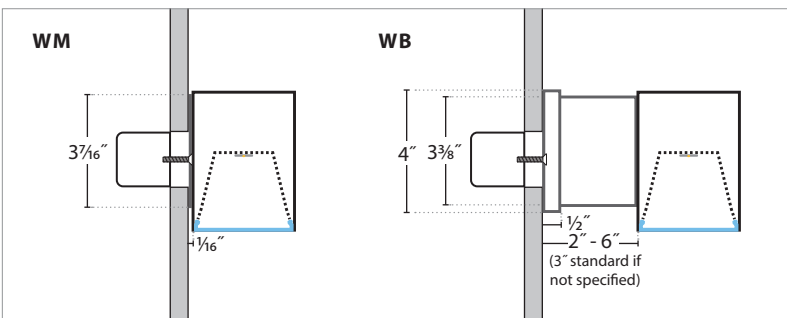

FIXTURE SIZE VARIES



## SURFACE (SURF) — MOUNTING

● POWER FEED

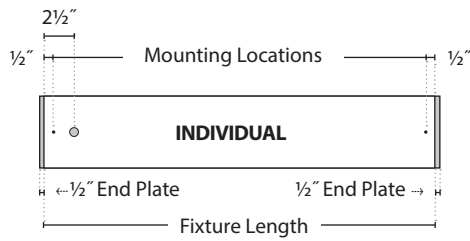
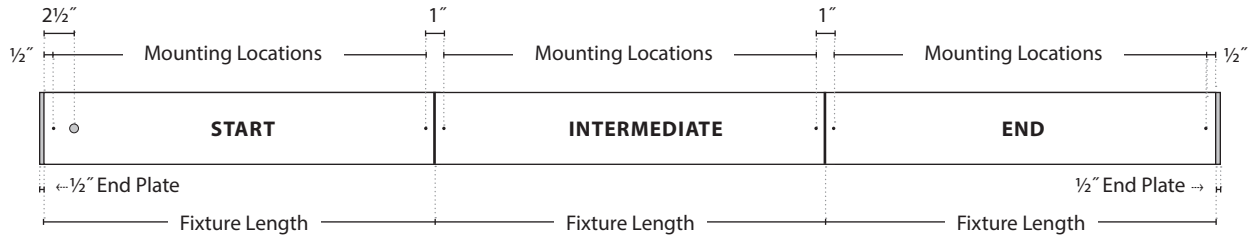

	FIXTURE LENGTHS	MOUNTING LOCATIONS
2'	24"	23"
3'	36"	35"
4'	48"	47"
5'	60"	59"
6'	72"	71"
7'	84"	83"
8'	96"	95"

## WALL (WM) — MOUNTING

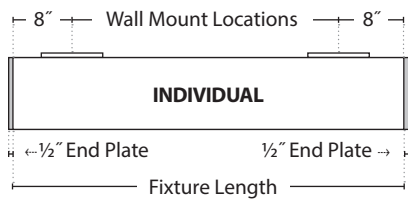
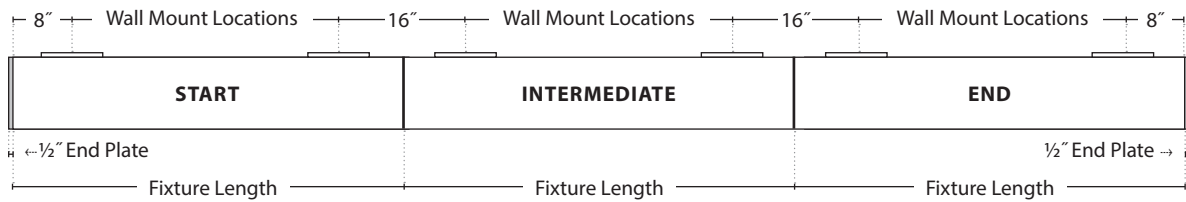

	FIXTURE LENGTHS	WALL MOUNT LOCATIONS
2'	24"	8"
3'	36"	20"
4'	48"	32"
5'	60"	44"
6'	72"	56"
7'	84"	68"
8'	96"	80"



### Why Channels?

Channels provide maximum flexibility in mounting points on the ceiling/wall (drilled in the field into structure).  
 2 mounting points per channel required, all channels are the length of the fixture. .75" Channel accommodates SOOW cord (8 foot, 6 conductor cord), 2" Channel accommodates liquitite Flex with sealed connectors (6' long 6' conductor cord).

WMC — WALL

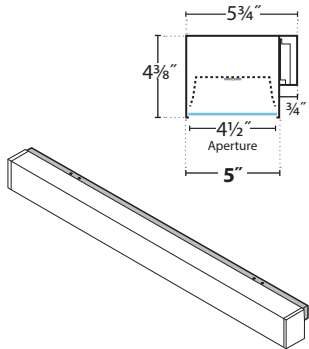

WMC2 — WALL

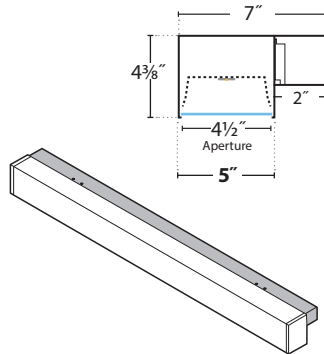

WMC — SURFACE

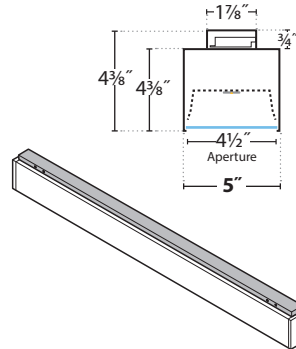

WMC2 — SURFACE

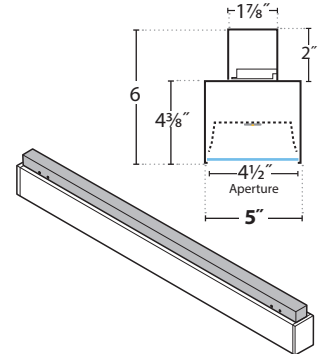

### Why Brackets?

Clean look. Two options.

1. Installed at our standard dimensions.
2. COS (Custom on-center spacing) — Provide dimensions and our factory will install bracket cleats at provided dimensions.

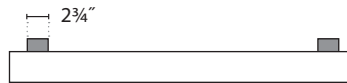

WMU — WALL

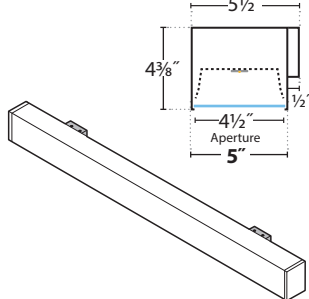

WMU1 — WALL

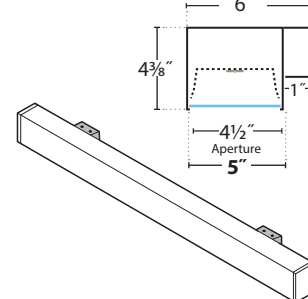

WMU2 — WALL

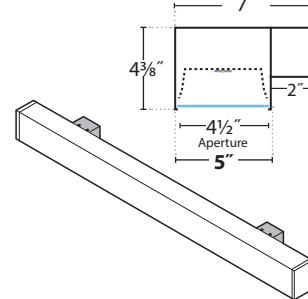

WMU — SURFACE

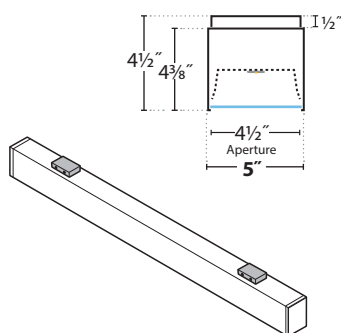

WMU1 — SURFACE

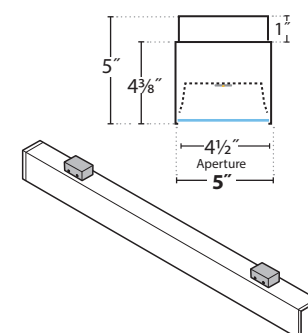

WMU2 — SURFACE

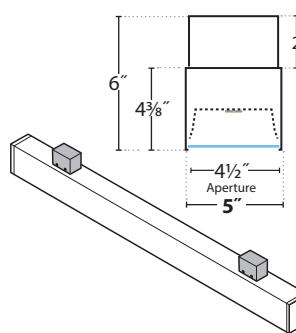

CA — CABLE MOUNT

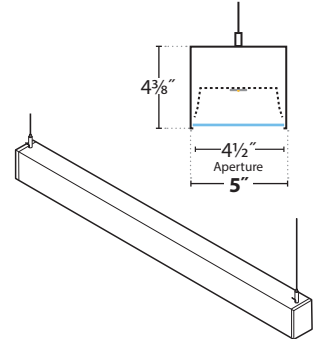

R/SSC — STEM MOUNT

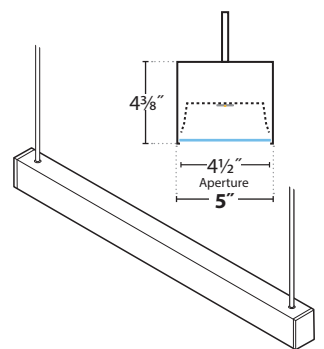



## CABLE (CA) — MOUNTING

**NOTE: 2' ROW FIXTURES NOT AVAILABLE**

○ POWER FEED

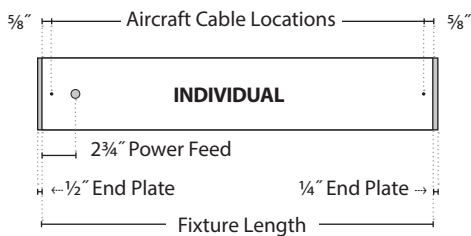
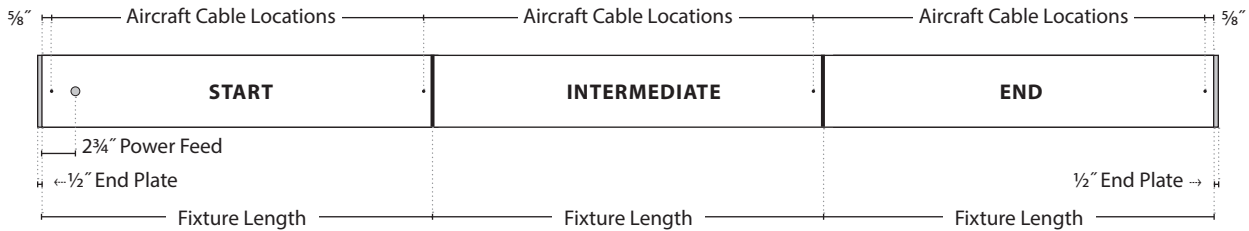

	AIRCRAFT CABLE LOCATIONS		
	All	Start / Individual	Intermediate / End
2'	24"	22 <sup>3</sup> / <sub>4</sub> "	24"
3'	36"	34 <sup>3</sup> / <sub>4</sub> "	36"
4'	48"	46 <sup>3</sup> / <sub>4</sub> "	48"
5'	60"	58 <sup>3</sup> / <sub>4</sub> "	60"
6'	72"	70 <sup>3</sup> / <sub>4</sub> "	72"
7'	84"	82 <sup>3</sup> / <sub>4</sub> "	84"
8'	96"	94 <sup>3</sup> / <sub>4</sub> "	96"

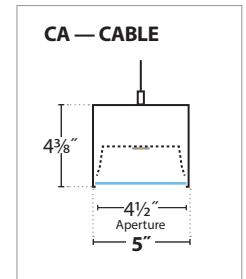

## STEM (RSC/SSC) — MOUNTING

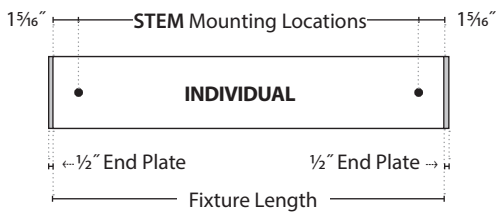
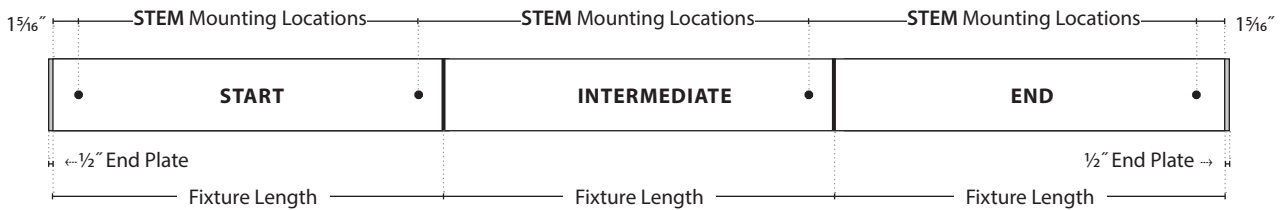

	AIRCRAFT CABLE LOCATIONS		
	All	Start / Individual	Intermediate / End
2'	24"	21 <sup>3</sup> / <sub>4</sub> "	24"
3'	36"	33 <sup>3</sup> / <sub>4</sub> "	36"
4'	48"	45 <sup>3</sup> / <sub>4</sub> "	48"
5'	60"	57 <sup>3</sup> / <sub>4</sub> "	60"
6'	72"	69 <sup>3</sup> / <sub>4</sub> "	72"
7'	84"	81 <sup>3</sup> / <sub>4</sub> "	84"
8'	96"	93 <sup>3</sup> / <sub>4</sub> "	96"

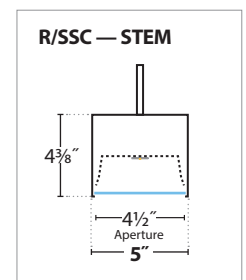



WMC/WMC2 (CHANNELS): WALL — MOUNTING

NOTE: 2' ROW FIXTURES NOT AVAILABLE

○ POWER FEED

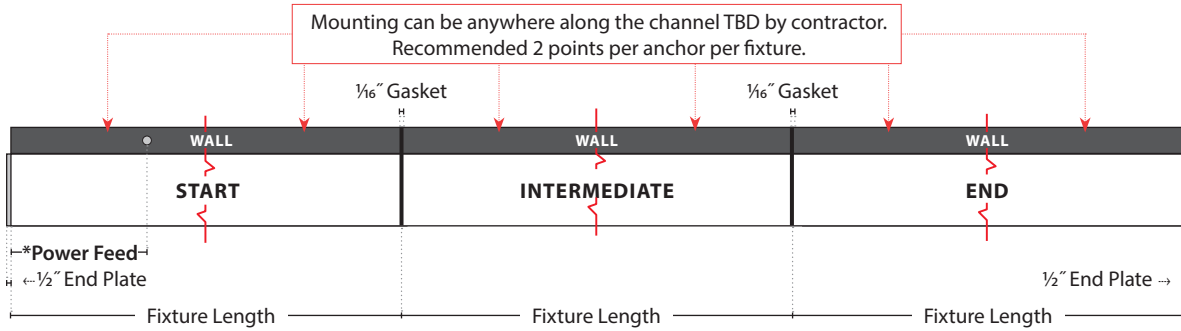

INDIVIDUAL (2'):

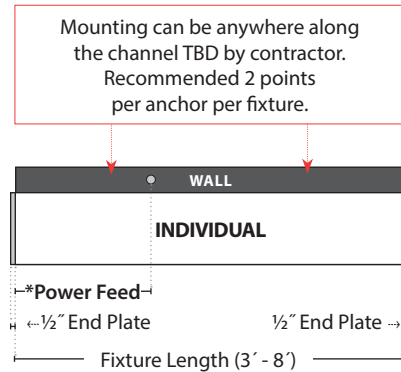
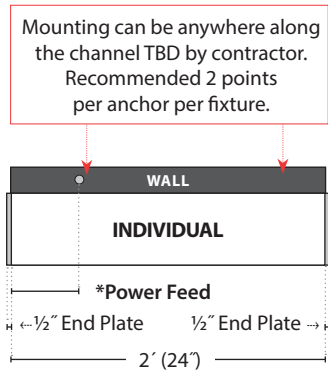

	FIXTURE LENGTHS	
	*Power Feed	All
2'	4"	24"
3'	10"	36"
4'	10"	48"
5'	10"	60"
6'	36"	72"
7'	42"	84"
8'	48"	96"

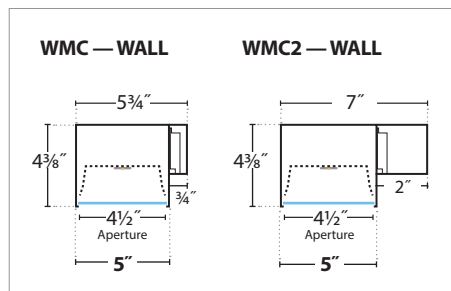



## WMC/WMC2 (CHANNELS): SURFACE — MOUNTING

**NOTE: 2' ROW FIXTURES NOT AVAILABLE**

○ POWER FEED

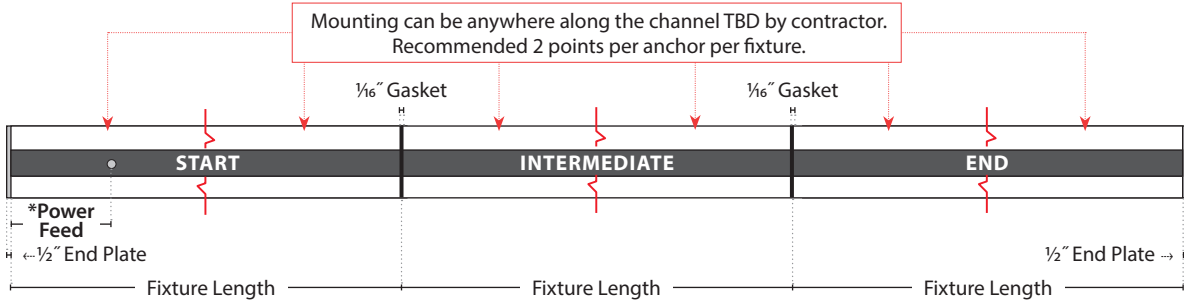

### INDIVIDUAL (2')

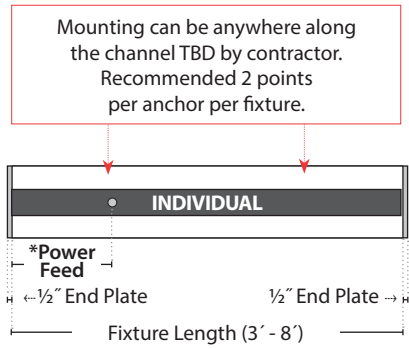
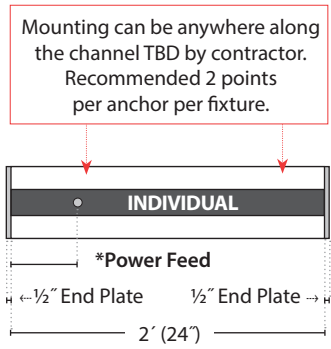

	FIXTURE LENGTHS	
	*Power Feed	All
2'	4"	24"
3'	6"	36"
4'	6"	48"
5'	6"	60"
6'	36"	72"
7'	42"	84"
8'	48"	96"

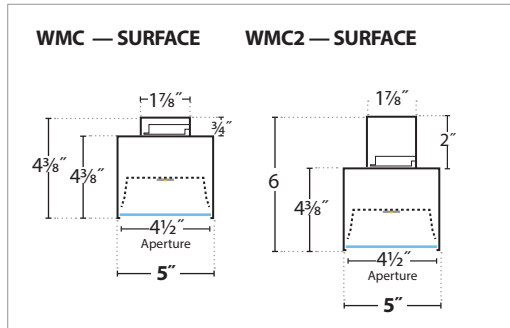



WMU/WMU1/WMU2 (BRACKETS): WALL — MOUNTING

NOTE: 2' ROW FIXTURES NOT AVAILABLE

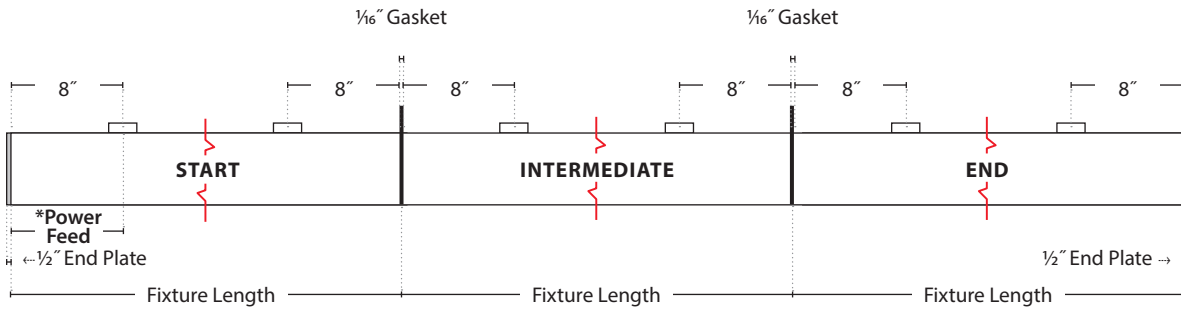

INDIVIDUAL (2'):

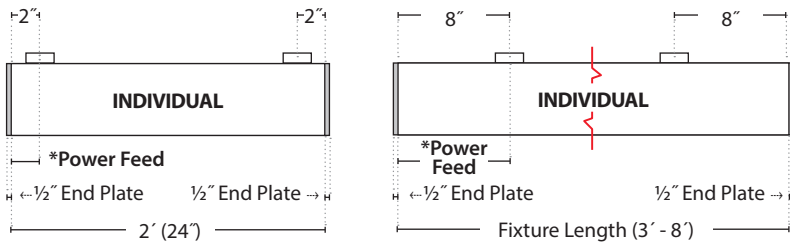

	FIXTURE LENGTHS		MOUNTING LOCATIONS		COS (Custom On-Center Spacing)
	*Power Feed	All	Start / Intermediate / End	Individual	
2'	2"	24"	—	20"	Customer to provide on-center mounting dimensions, PRU will pre-drill and mount Brackets
3'	8"	36"	20"	20"	
4'	8"	48"	32"	32"	
5'	8"	60"	44"	44"	
6'	8"	72"	56"	56"	
7'	8"	84"	68"	68"	
8'	8"	96"	80"	80"	

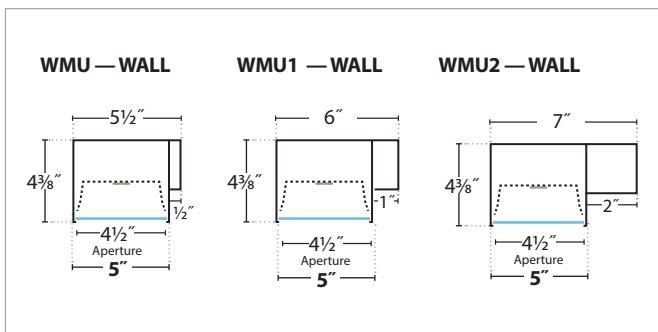



WMU/WMU1/WMU2 (BRACKETS): SURFACE — MOUNTING

NOTE: 2' ROW FIXTURES NOT AVAILABLE

○ POWER FEED

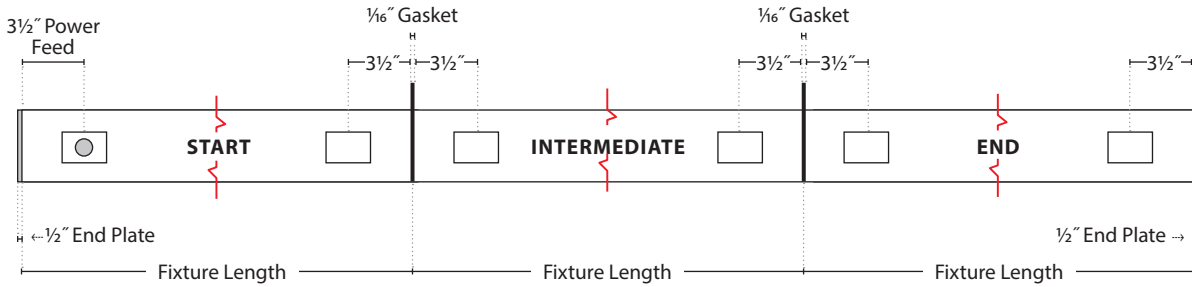

INDIVIDUAL (2'):

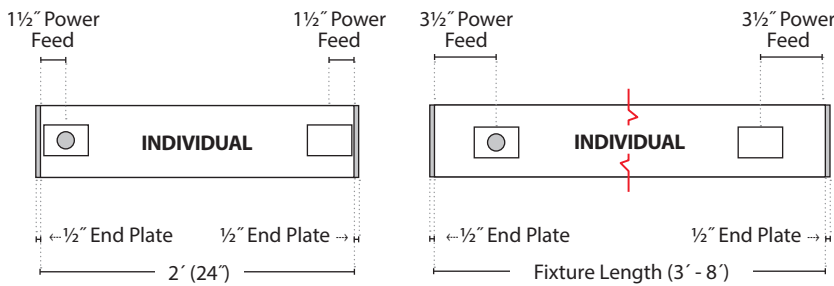

FIXTURE LENGTHS	MOUNTING LOCATIONS			COS (Custom On-Center Spacing)
	All	Start / Intermediate / End	Individual	
2'	24"	—	21"	Customer to provide on-center mounting dimensions, PRU will pre-drill and mount Brackets
3'	36"	29"	29"	
4'	48"	41"	41"	
5'	60"	53"	53"	
6'	72"	65"	65"	
7'	84"	77"	77"	
8'	96"	89"	89"	

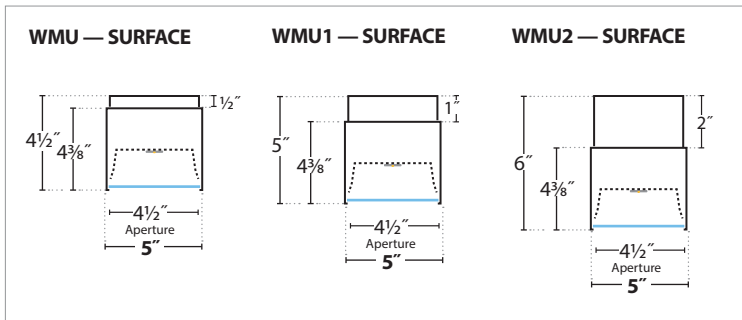



## Corners

**C2-60:**

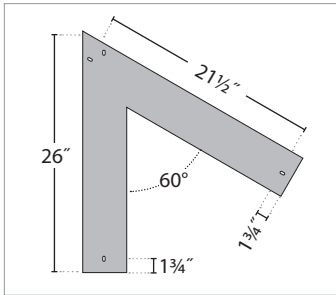

**C2-90:**

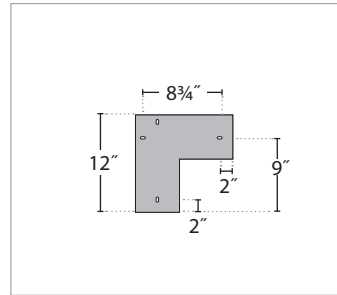

**C2-120:**

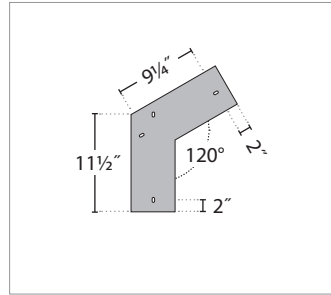

**C2-135:**

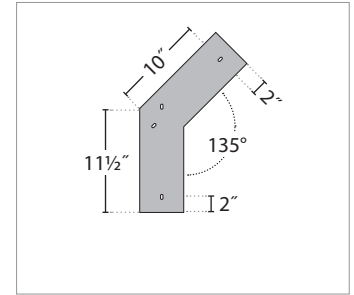

**C3T:**

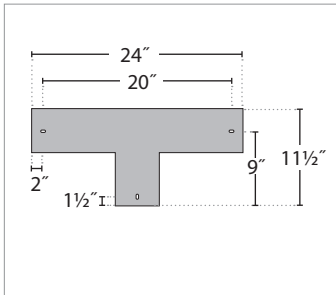

**C3Y:**

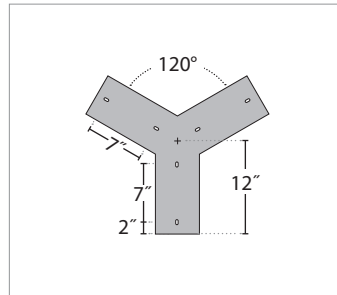

**C4T:**

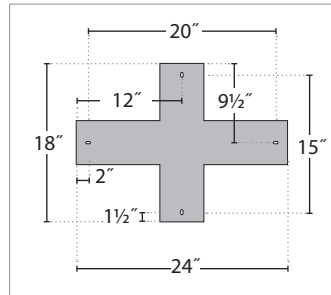

**C4X:**

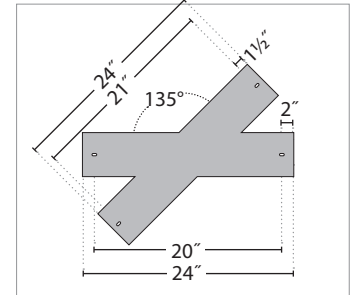

**C8I:**

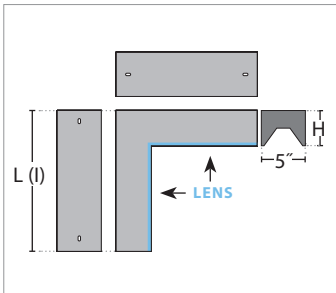

**C8O:**

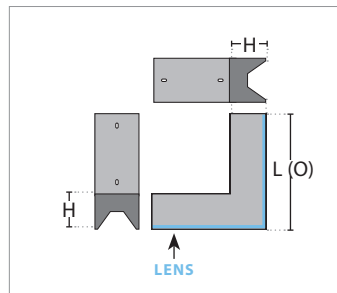

BODY TYPE	DIM "H"	DIM "L" (I)	DIM "L" (O)
Direct Flush	4 3/8"	16 3/8"	12"
Direct Regress	4 7/8"	16 3/8"	12 1/2"
Direct/Indirect Flush	5"	17"	12"
Direct/Indirect Regress	5 1/2"	17"	12 1/2"

## SENSOR PLATE

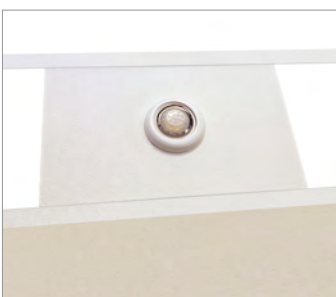

90° louver corners available, consult factory for other corners



## FTR END OF ROW FEATHERING

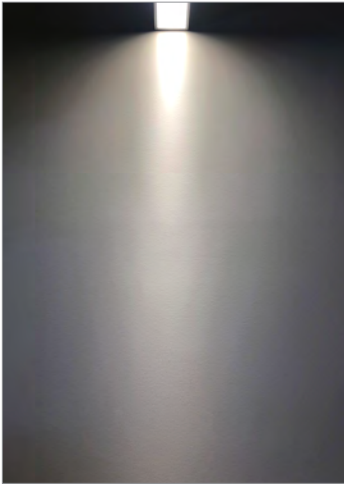

Wall to wall (WTW) fixtures can project strong lighting distributions on perpendicular wall which some find undesirable.

Medium Wall Graze (MGZ) shown above.

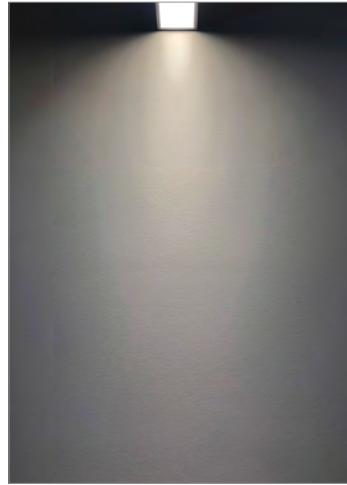

Feather (FTR) softens distributions on perpendicular walls.

Medium Wall Graze (MGZ) shown above with FTR.

## LGP LOW GLARE PRISMATIC LENS

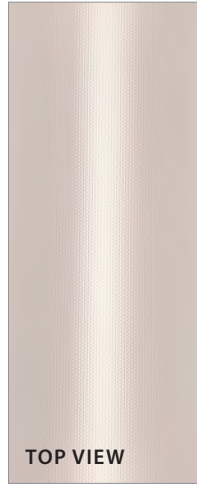

TOP VIEW



SIDE VIEW

Low Glare Prismatic lens has a dynamic 'prismatic stripe' that 'follows the viewer' and offers a sense of depth. The narrow distribution has low glare (UGR) and meets WELL UGR of 16 or lower. It utilizes the FTR Diffuser (see below).

**NOTE:** Our Batwing lens also meets WELL UGR of 16 or less (BioPro 3-4-5)



WELL OPTION 1 B,  
FIXTURE UGR 16 OR LESS

## FTR (FEATHERING DIFFUSER) DETAIL

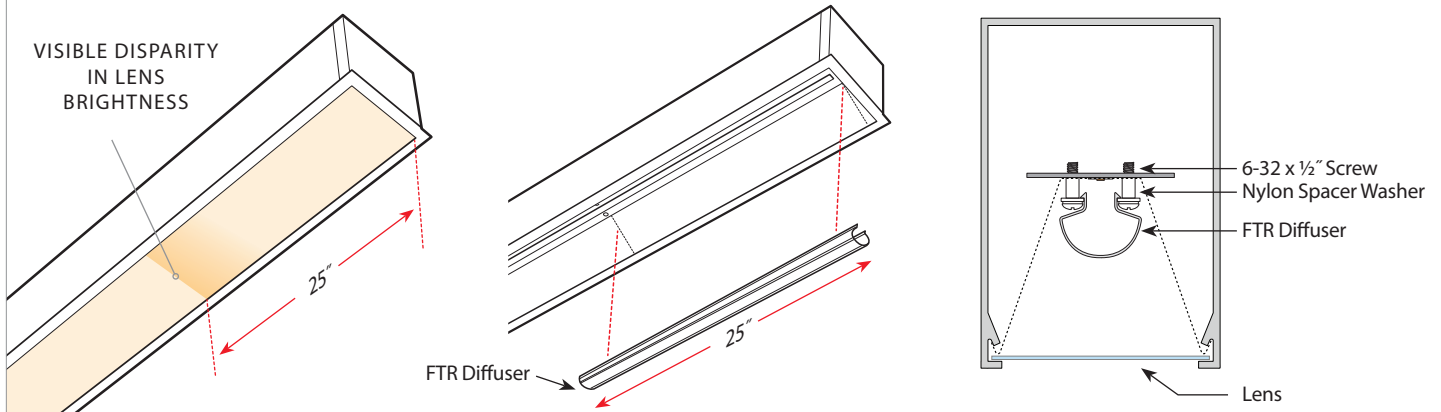

**NOTE:** Using FTR creates a visible disparity in lens brightness when viewed from directly below. FTR is NOT available dual-sided on two corners 5' or less.



## ROW BUILDER

### 18' STANDARD ROW LENGTH:

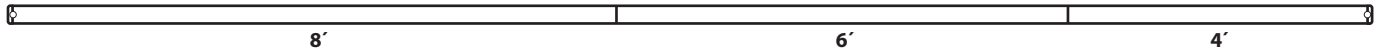

### 18' SYMMETRIC ROW LENGTH (SRL):

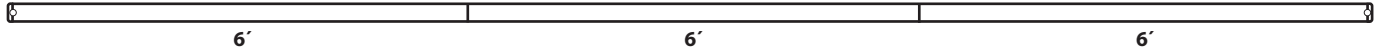

#### STANDARD

ROW LENGTH		
9'	5+4	5FT STR + 4FT END
10'	6+4	6FT STR + 4FT END
11'	7+4	7FT STR + 4FT END
12'	8+4	8FT STR + 4FT END
13'	8+5	8FT STR + 5FT END
14'	8+6	8FT STR + 6FT END
15'	8+7	8FT STR + 7FT END
16'	8+8	8FT STR + 8FT END
17'	8+5+4	8FT STR + 5FT INT + 4FT END
18'	8+6+4	8FT STR + 6FT INT + 4FT END
19'	8+7+4	8FT STR + 7FT INT + 4FT END
20'	8+8+4	8FT STR + 8FT INT + 4FT END
21'	8+8+5	8FT STR + 8FT INT + 5FT END
22'	8+8+6	8FT STR + 8FT INT + 6FT END
23'	8+8+7	8FT STR + 8FT INT + 7FT END
24'	8+8+8	8FT STR + 8FT INT + 8FT END
25'	8+8+5+4	8FT STR + 8FT INT + 5FT INT + 4FT END
26'	8+8+6+4	8FT STR + 8FT INT + 6FT INT + 4FT END
27'	8+8+7+4	8FT STR + 8FT INT + 7FT INT + 4FT END
28'	8+8+8+4	8FT STR + (2) 8FT INT + 4FT END
29'	8+8+8+5	8FT STR + (2) 8FT INT + 5FT END
30'	8+8+8+6	8FT STR + (2) 8FT INT + 6FT END
31'	8+8+8+7	8FT STR + (2) 8FT INT + 7FT END
32'	8+8+8+8	8FT STR + (2) 8FT INT + 8FT END
33'	8+8+8+5+4	8FT STR + (2) 8FT INT + 5FT INT + 4FT END
34'	8+8+8+6+4	8FT STR + (2) 8FT INT + 6FT INT + 4FT END
35'	8+8+8+7+4	8FT STR + (2) 8FT INT + 7FT INT + 4FT END
36'	8+8+8+8+4	8FT STR + (3) 8FT INT + 4FT END
37'	8+8+8+8+5	8FT STR + (3) 8FT INT + 5FT END
38'	8+8+8+8+6	8FT STR + (3) 8FT INT + 6FT END
39'	8+8+8+8+7	8FT STR + (3) 8FT INT + 7FT END
40'	8+8+8+8+8	8FT STR + (3) 8FT INT + 8FT END
41'	8+8+8+8+5+4	8FT STR + (3) 8FT INT + 5FT INT + 4FT END
42'	8+8+8+8+6+4	8FT STR + (3) 8FT INT + 6FT INT + 4FT END
43'	8+8+8+8+7+4	8FT STR + (3) 8FT INT + 7FT INT + 4FT END
44'	8+8+8+8+8+4	8FT STR + (4) 8FT INT + 4FT END
45'	8+8+8+8+8+5	8FT STR + (4) 8FT INT + 5FT END
46'	8+8+8+8+8+6	8FT STR + (4) 8FT INT + 6FT END
47'	8+8+8+8+8+7	8FT STR + (4) 8FT INT + 7FT END
48'	8+8+8+8+8+8	8FT STR + (4) 8FT INT + 8FT END
49'	8+8+8+8+8+5+4	8FT STR + (4) 8FT INT + 5FT INT + 4FT END
50'	8+8+8+8+8+6+4	8FT STR + (4) 8FT INT + 6FT INT + 4FT END

#### SYMMETRICAL

ROW LENGTH		
9'	3+3+3	3FT STR + 3FT INT + 3FT END
10'	5+5	5FT STR + 5FT END
11'	4+3+4	4FT STR + 3FT INT + 4FT END
12'	6+6	6FT STR + 6FT END
13'	4+5+4	4FT STR + 5FT INT + 4FT END
14'	7+7	7FT STR + 7FT END
15'	5+5+5	5FT STR + 5FT INT + 5FT END
16'	8+8	8FT STR + 8FT END
17'	6+5+6	6FT STR + 5FT INT + 6FT END
18'	6+6+6	6FT STR + 6FT INT + 6FT END
19'	6+7+6	6FT STR + 7FT INT + 6FT END
20'	8+4+8	8FT STR + 4FT INT + 8FT END
21'	8+5+8	8FT STR + 5FT INT + 8FT END
22'	8+6+8	8FT STR + 6FT INT + 8FT END
23'	8+7+8	8FT STR + 7FT INT + 8FT END
24'	8+8+8	8FT STR + 8FT INT + 8FT END
25'	6+4+5+4+6	6FT STR + 4FT INT + 5FT INT + 4FT INT + 6FT END
26'	8+5+5+8	8FT STR + (2) 5FT INT + 8FT END
27'	6+5+5+5+6	6FT STR + (3) 5FT INT + 6FT END
28'	8+6+6+8	8FT STR + (2) 6FT INT + 8FT END
29'	8+4+5+4+8	8FT STR + 4FT INT + 5FT INT + 4FT INT + 8FT END
30'	8+7+7+8	8FT STR + (2) 7FT INT + 8FT END
31'	8+5+5+5+8	8FT STR + (3) 5FT INT + 8FT END
32'	8+8+8+8	8FT STR + (2) 8FT INT + 8FT END
33'	8+6+5+6+8	8FT STR + 6FT INT + 5FT INT + 6FT INT + 8FT END
34'	8+6+6+6+8	8FT STR + 6FT INT + 6FT INT + 6FT INT + 8FT END
35'	8+6+7+6+8	8FT STR + 6FT INT + 7FT INT + 6FT INT + 8FT END
36'	8+8+4+8+8	8FT STR + 8FT INT + 4FT INT + 8FT INT + 8FT END
37'	8+8+5+8+8	8FT STR + 8FT INT + 5FT INT + 8FT INT + 8FT END
38'	8+8+6+8+8	8FT STR + 8FT INT + 6FT INT + 8FT INT + 8FT END
39'	8+8+7+8+8	8FT STR + 8FT INT + 7FT INT + 8FT INT + 8FT END
40'	8+8+8+8+8	8FT STR + (3) 8FT INT + 8FT END
41'	8+6+4+5+4+6+8	8FT STR + 6FT INT + 4FT INT + 5FT INT + 4FT INT + 6FT INT + 8FT END
42'	8+8+5+5+8+8	8FT STR + 8FT INT + (2) 5FT INT + 8FT INT + 8FT END
43'	8+6+5+5+5+6+8	8FT STR + 6FT INT + (3) 5FT INT + 6FT INT + 8FT END
44'	8+8+6+6+8+8	8FT STR + 8FT INT + (2) 6FT INT + 8FT INT + 8FT END
45'	8+8+4+5+4+8+8	8FT STR + 8FT INT + 4FT INT + 5FT INT + 4FT INT + 8FT INT + 8FT END
46'	8+8+7+7+8+8	8FT STR + 8FT INT + (2) 7FT INT + 8FT INT + 8FT END
47'	8+8+5+5+5+8+8	8FT STR + 8FT INT + (3) 5FT INT + 8FT INT + 8FT END
48'	8+8+8+8+8+8	8FT STR + (4) 8FT INT + 8FT END
49'	8+8+6+5+6+8+8	8FT STR + 8FT INT + 6FT INT + 5FT INT + 6FT INT + 8FT INT + 8FT END
50'	8+8+6+6+6+8+8	8FT STR + 8FT INT + (3) 6FT INT + 8FT INT + 8FT END



## BionicPro5 Batwing Vs. Top 5" Competitor (Satin Lens)

### SINGLE OFFICE

#### BionicPro5



#### Top Competitor

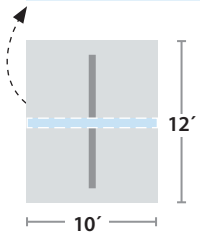

	BionicPro5	Competitor
LPW	131	113
<b>SPACING CRITERIA</b>	<b>1.95</b>	<b>1.2</b>
MAX/MIN	1.7	2.3
W/SQ. FT.	.38	.4
FC AVERAGE	27	29

9' ceiling .85 l/f BionicPro5—5.7w/ft Competitor—6w/ft Footcandles at 30" working plane

### OPEN OFFICE

#### BionicPro5

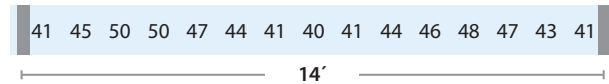

#### Top Competitor

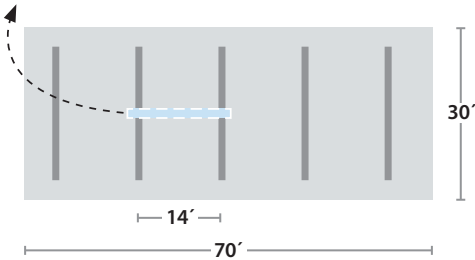
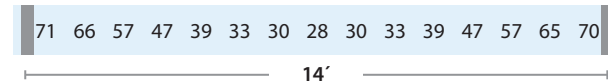

	BionicPro5	Competitor
LPW	131	113
<b>SPACING CRITERIA</b>	<b>1.95</b>	<b>1.2</b>
MAX/MIN	2.2	3.9
MAX/MIN BETWEEN ROWS	1.2	2.5
W/SQ. FT.	.36	.38
FC AVERAGE	36	37

9' ceiling .85 l/f BionicPro5—5.7w/ft Competitor—6w/ft Footcandles at 30" working plane



### Smooth, flat wall washing (WWF)

Our patent-pending TruBeam™ optics redirect light in an ideal flat wall wash for smooth, even illumination.

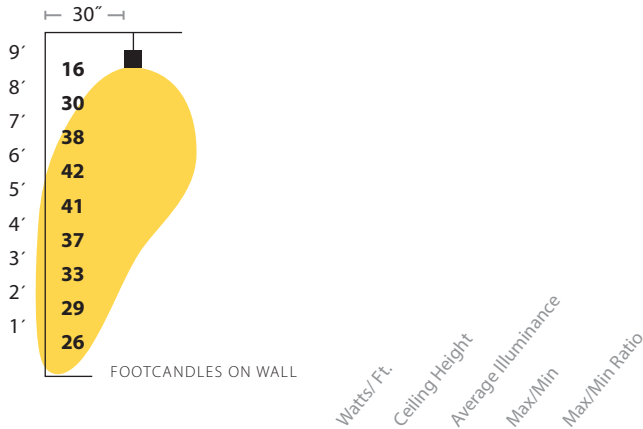

<b>Medium Output</b>   700 lumens/ft	6	9'	<b>32 fc</b>	42/16	2.6
--------------------------------------	---	----	--------------	-------	-----

### Focal glow wall washing (WWG)

Pique interest by giving works of art 'pop' — more light at eye level

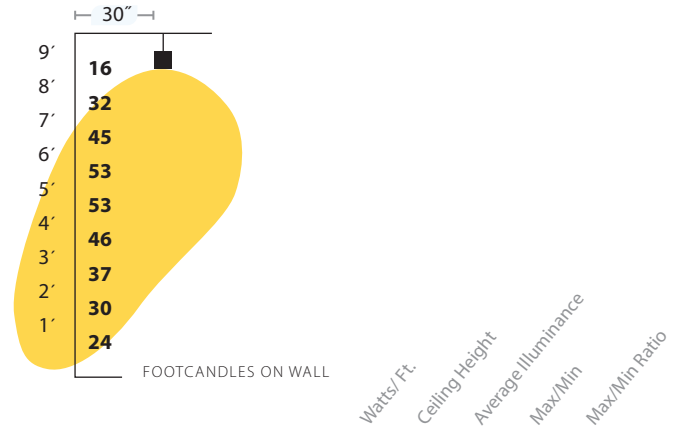

<b>Medium Output</b>   700 lumens/ft	6	9'	<b>37 fc</b>	53/16	3.3
--------------------------------------	---	----	--------------	-------	-----

### Perimeter Fill (PFL)

Wash a corridor in light from one side of the perimeter. Our Perimeter Fill is ideal for hospital corridors where a 50 fc average is needed.

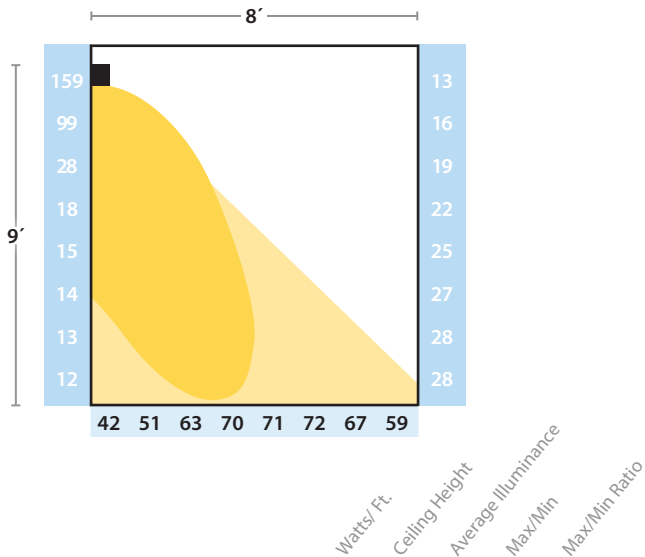

<b>High Output</b>   1225 lumens/ft	1	10'	<b>65 fc</b>	74/59	1.2
-------------------------------------	---	-----	--------------	-------	-----

### Medium Wall Graze (MGZ)

Wall grazing performance often better just off a wall.

**DIRECT TO WALL (WM)    WALL BRACKET (WB)**

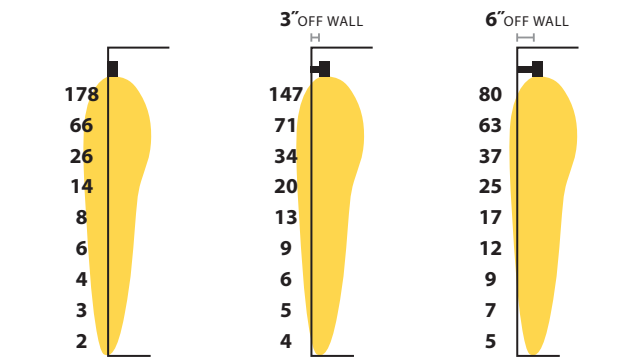

See perimeter specs

**USE WB WALL BRACKET FOR BETTER PERFORMANCE THAN FLUSH TO WALL**



## Hard Ceiling Wash (HCW)

**OPEN OFFICE/CLASSROOM**

Hung 18" below ceiling

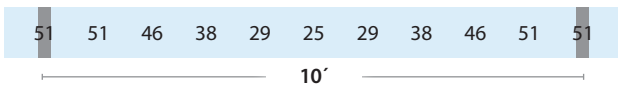
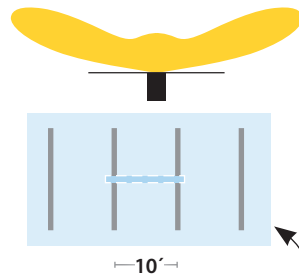

## Medium Ceiling Wash (MCW)

**SINGLE OFFICE OR  
OTHER SMALL CEILING**

Hung 18" below ceiling

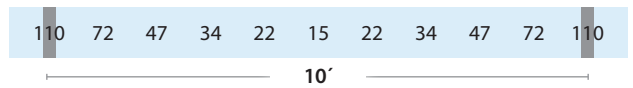
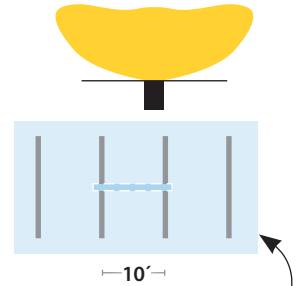

## Soft Ceiling Wash (SCW)

**SINGLE OFFICE OR  
OTHER SMALL CEILING**

Hung 18" below ceiling

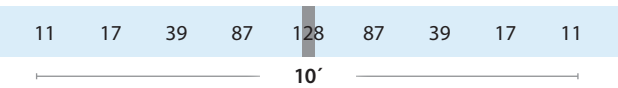
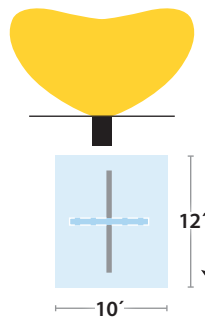

## BionicPro to Bionic/P23-43 Optics Crossing Matrix

**DOWNLIGHT:**

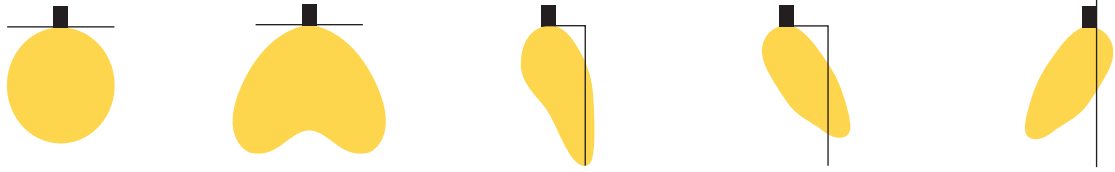

	Satin	Batwing	Flat Wall Wash	Focal Glow Wall Wash	Perimeter Fill
BionicPro	SAL	BTW	WWF	WWG	PFL
Bio2 / P23 = BionicPro3	SAL	MBW	MWW/D1W	—	MWW/D1R
Bionic4 / P43 = BionicPro4	SAL	ABW/D1X	—	AWL/D1W	AWL/D1R

WWG = PFL  
Lens aimed away from wall

**UPLIGHT:**

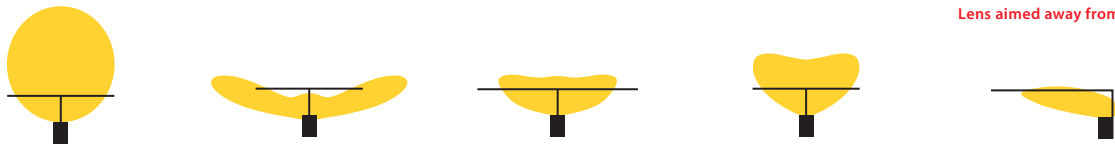

	Symmetric	Hard Ceiling Wash	Medium Ceiling Wash	Soft Ceiling Wash	Asymmetric Ceiling Wash
BionicPro	SYM	HCW NA BionicPro2	MCW	SCW	SACW
Bio2 / P23 = BionicPro3	SYM	CW	CW	—	ACW
Bionic4 / P43 = BionicPro4	SYM	CW	CW	—	—



WIRING DIAGRAMS  
SPEC



PRUDENTIAL LTG.

PRULITE.COM 213.746.0360

Lumen Outputs:		BLUHUE, TUHUE, TUHUE2, AMBERHUE			
<b>DIRECT:</b>		LO	MO	SO	HO*
SAL	Lm/Ft	205	385	550	715
BTW / WWG / PFL	Lm/Ft	215	395	565	730
LGP / WWF / MGZ	Lm/Ft	225	405	580	750
	W/Ft	3.8	5.6	7.8	10.5
<b>INDIRECT:</b>		LO	MO	SO	HO*
SYM	Lm/Ft	360	480	630	800
HCW	Lm/Ft	150	300	450	575
SCW	Lm/Ft	350	525	700	870
SACW	Lm/Ft	300	450	600	720
	W/Ft	3.8	5.6	7.8	10.5

\*\* TU2 + AMB NOT AVAILABLE HO / CHROMAHUE ONLY AVAILABLE ON HO



Prudential Lighting's **TuHue** Tunable White provides warm to cool white light simulating sunlight. Controlling the light source color temperature offers differing design aesthetics with potential benefits via circadian rhythm support. Blue light for alertness while warm light conveys tranquility.

- 2700K-6500K or 2200K-5000K.
- Adjust the color temperate and brightness separately.
- Simulates warm to cool to warm transition of sunlight.

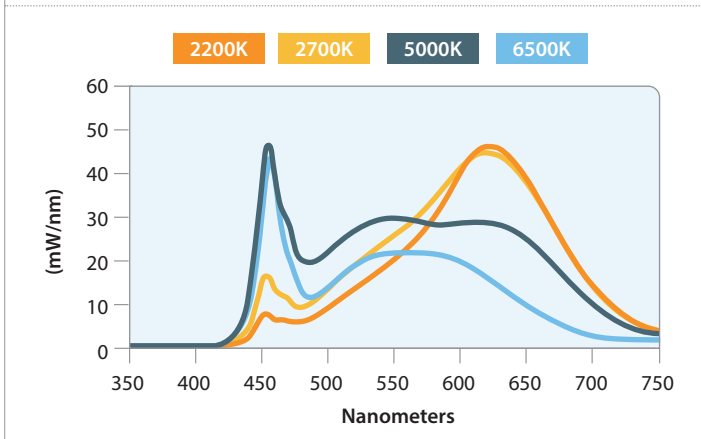
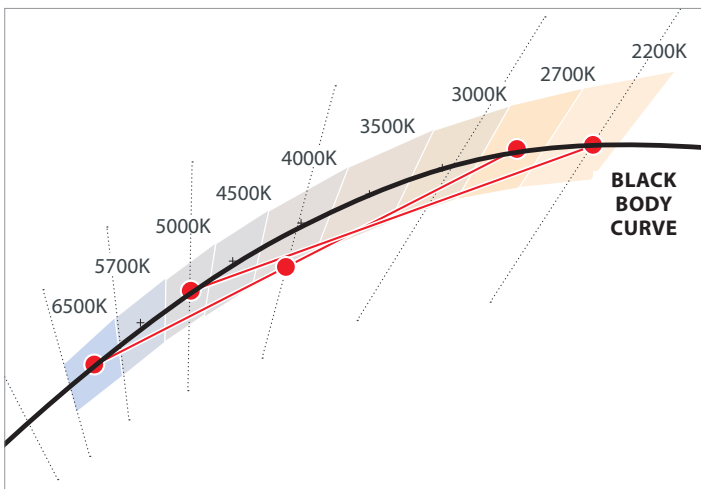

**BluHue BIOS SkyBlue™** circadian LED lighting brings the benefits of blue skies inside. Newly discovered blue-sky receptors in our eyes drive improved daytime alertness, mood, brain function, and strengthens circadian rhythms leading to overall better health and well-being.

- Circadian rhythms play an integral role in physical and mental health.
- BluHue BIOS SkyBlue pinpoints peak 490nm sensitivity to provide the most benefit from an electric light source.
- At night, simply dim the lights to remove SkyBlue™ wavelengths (specify "Blu\_D" to dim Cyan SkyBlue spike separately [night mode]).

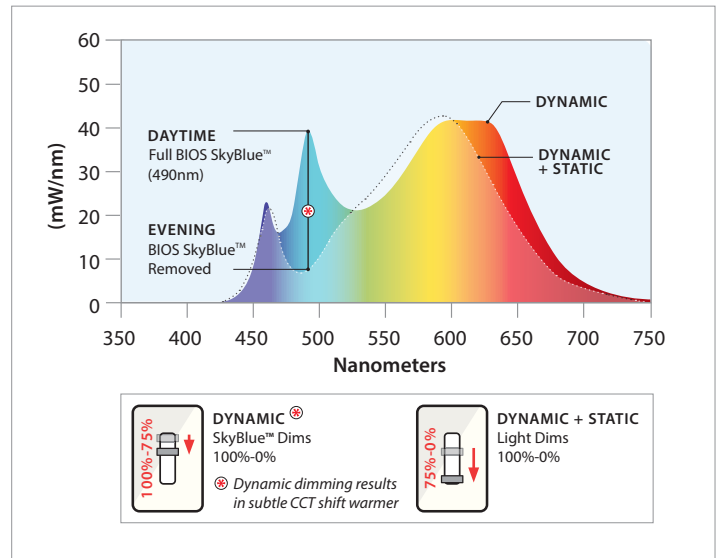

**AmberHue** is Prudential Lighting's Warm Dim offering. It transitions bright white light to warm amber light as brightness is dimmed, reflecting sunlight's transitioning from intense blue midday light to a dimmed golden hue near sunset, also reminiscent of soft glowing candlelight.

- Warm Dim 2200K-5000K.
- Color temperature warms as the luminaire is dimmed.
- Calm, relaxing mood communicated – hospitality, residential feel.

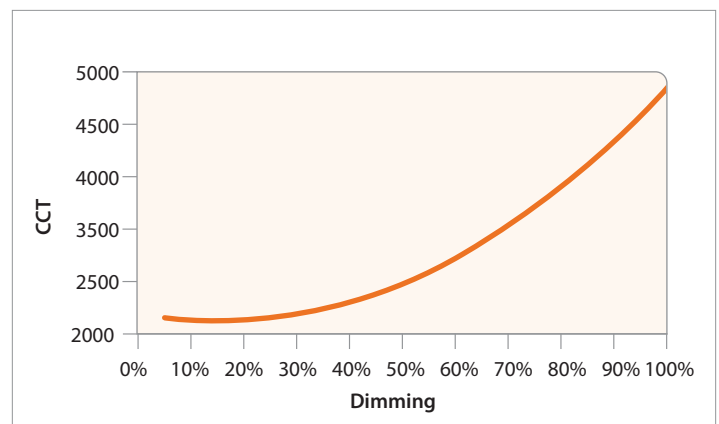



**ChromaHue** offers a vibrant full gamut of colors for seemingly endless architectural interior applications. Rich color-changing light offers tremendous design flexibility while white light can be achieved with the White chip, or mixing of Red, Green and Blue light. No longer just for the entertainment industry, ChromaHue can be intermixed on BionicPro luminaires for mood-creating indirect illumination combined with static white direct light.

- RGBW LED array (Red, Green, Blue, White) with full spectrum color and white light on the black body curve.
- Four-channel control, DMX drivers.
- Any color point within the triangle can be reached by setting the proper output levels for each individual red, green, blue and white channels.
- Standard DMX is one zone with one XLR drop at start, one XLR return at the end.

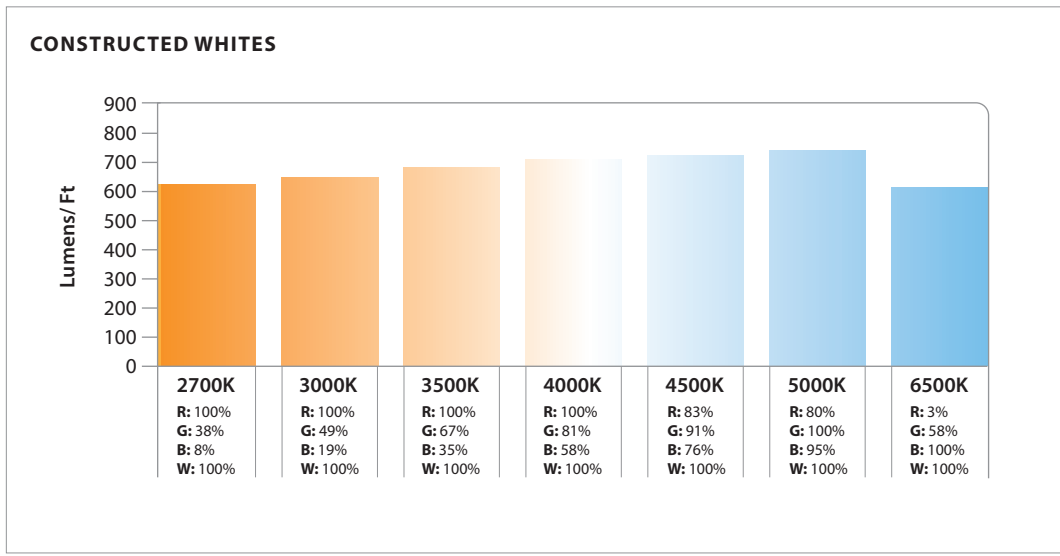
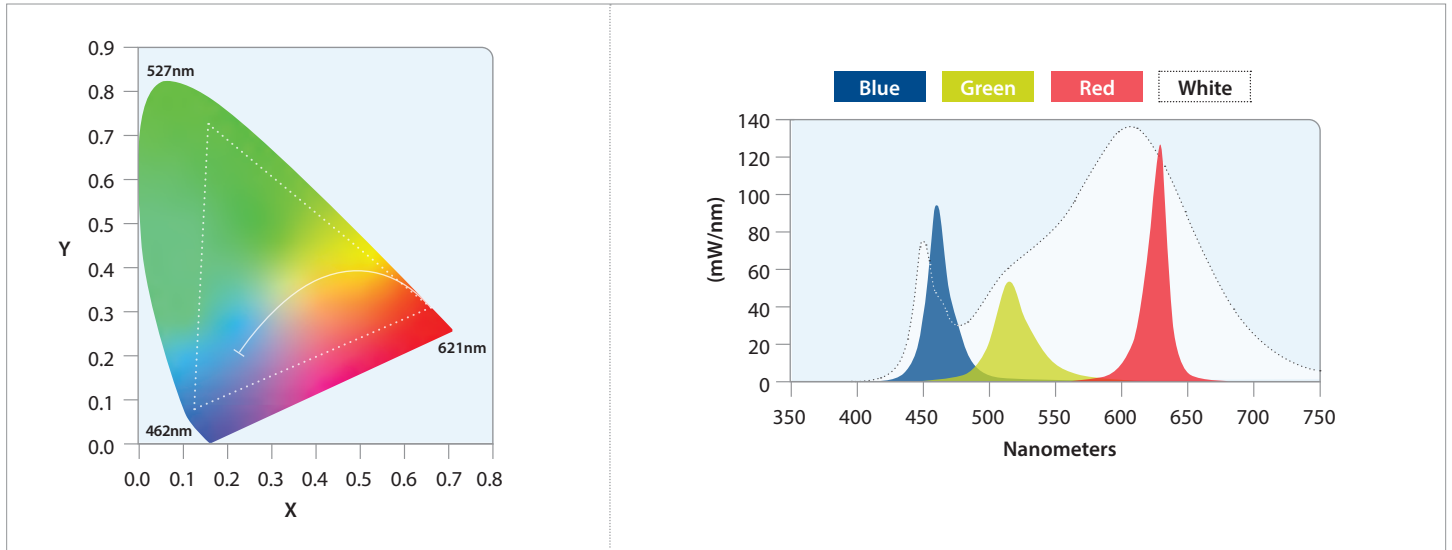



## LM79 & TM30 DATA:

	MEASURED CCT	MEASURED LUMENS	CRI	R9	DuV	SPD	TM30 — COLOR VECTOR	TM30 — COLOR DISTORTION
<b>LED27</b>	2680	80%	93	58	0.001		 89 Rf	 97 Rg
<b>LED3</b>	3042	95%	82	6	0.001		 81 Rf	 92 Rg
<b>LED3-90</b>	3016	85%	93	61	0.000		 88 Rf	 96 Rg
<b>LED35</b>	3482	100%	82	3	0.002		 81 Rf	 92 Rg
<b>LED35-90</b>	3417	85%	93	67	0.000		 88 Rf	 96 Rg
<b>LED4</b>	3952	102%	82	4	0.003		 81 Rf	 92 Rg
<b>LED4-90</b>	3882	85%	92	67	0.003		 87 Rf	 96 Rg
<b>LED5-90</b>	4889	85%	94	84	0.002		 86 Rf	 95 Rg











## LM79 & TM30 DATA:

		MEASURED CCT	MEASURED LUMENS	CRI	R9	LED27	SPD	TM30 — COLOR VECTOR
<b>BH3S&amp;D</b>	bioS 3000K	2779	2758	87	81	0.003		
	<b>BH3D</b> SKY BLUE DIMMED	2715	2425	82	3	0.002		
<b>BH35S&amp;D</b>	bioS 3500K	3245	2919	85	87	0.003		
	<b>BH35D</b> SKY BLUE DIMMED	3061	2502	83	7	0.001		
<b>BH4&amp;D</b>	bioS 4000K	3624	2993	85	86	0.004		
	<b>BH4D</b> SKY BLUE DIMMED	3388	2585	83	5	0.002		
<b>TH</b>	LED27	2684	2456	92	57	0.0001		
	LED65	6061	3292	82	-1	0.006		
<b>TH2</b>	LED22	2209	2112	92	52	0.0005		
	LED50	4796	2789	93	77	0.004		
<b>CH</b>	2700K	2632	2469	82	50	0.003		
	3500K	3388	2585	83	5	0.002		
	4000K	3977	2682	83	29	0.003		
	5000K	5233	2823	84	21	0.003		



SENSORS

				
<b>205:</b> Wattstopper	<b>LVOC:</b> Lutron Occupancy /Daylight Sensor	<b>LVRF:</b> Lutron Vive Control Node	<b>NXSMP:</b> Hubbell Occupancy /Daylight Sensor	<b>ATHENA</b>
Low voltage PIR fixture integrated occupancy sensor.	Measures light in the space (daylighting) while detecting people moving within an area using passive infrared to determine occupancy.  Controls the lights to balance the light level in the space, combining convenience, exceptional energy savings, and ease of installation.	Provides wireless control of the fixture when neither occupancy nor daylight sensing is needed.	Hubbell Integrated/embedded networked lighting control, luminaire-level lighting control, LLLC.  PIR motion sensor for automatic On/Off control.  Integrated daylight sensor for daylight harvesting and/or lumen maintenance.  Bluetooth radio provides wireless control of luminaire.  Simple plug-in connection to NX Fixture Modules.  Wireless Internet.	The Athena wireless node is a radio frequency (RF) device that enables simple, digital control of individual light fixtures in an Athena control system.  The small size and compatibility with a wide variety of drivers allow for seamless integration with common commercial lighting fixtures from any manufacturer.  Requires drivers with auxiliary power, consult factory for lead times

			
<b>NLT-AIR-rIO:</b> Daylight+Occ	<b>NLT-AIR-ADCX:</b> Daylight+(PIR Acoustic) Occ	<b>NLT-WIRED-nIO:</b> Daylight+Occ	<b>NLT-WIRED-ADCX:</b> Daylight+(PIR Acoustic) Occ
The rIO is a fixture embedded low voltage wireless nLight AIR device capable of individual fixture control and analog or digital dimming. This smart device results in the luminaire being “nLight AIR-enabled” — making it an addressable nLight AIR device. It uses a 900MHz radio to communicate with other nLight AIR devices, such as occupancy sensors, photocells, wall switches, powerpacks and other nLight AIR-enabled luminaires. This allows for advanced operation and design flexibility ranging from stand-alone rooms to building and campus-wide networks.	The nLight® AIR rES7 sensor is an in-fixture, low voltage, digital sensor providing embedded wireless lighting control, analog or digital dimming, occupancy detection and daylight harvesting capabilities.  The rES7 is designed for mounting heights up to 20 ft in indoor luminaires. The rES7 sensor provides Passive Infrared (PIR) occupancy detection over a 15-20 ft (4.57 - 6.10 m) radial coverage pattern and photocell light level detection in one compact low profile design with optional Dual Technology, which adds Microphonics™ to PIR detection. The rES7 sensor is ideal for occupancy and daylighting control in suspended or recessed luminaires.	nLight digital nIO modules are low voltage control devices that enable digital control of LEDcode enabled eldoLED LED drivers. Through eldoLED's bi-directional 2-wire interface, these modules deliver natural, flicker-free high performance dimming while eliminating common issues related to 0-10 VDC alternatives. The modules also enable the eldoLED LED Drivers to be addressable, as well as capable of digitally communicating with other nLight controls such as occupancy sensors, photocells, and WallPods. This allows for advanced operation and design flexibility ranging from stand-alone rooms to building and campus-wide networks.	The nES7 is a small passive infrared occupancy sensor designed to be easily embedded into luminaires. This sensor provides excellent line of sight 360° PIR detection of small motion and walking motion. The nES7 is ideal for small rooms without obstructions or areas with primarily walking motion (e.g. corridors, library stacks). Additionally, an optional integrated photocell enables daylight harvesting control as well. Typically one or more nES7 sensors are paired with an nLight controller within an nLight enabled luminaire.  For rooms like classrooms and private offices or any space with obstructions, the nES PDT 7 dual technology sensor is recommended.