

LIGHT WALNUT

RED LEATHER

CARBON FIBER

VARA OAK

TUNABLE WHITE

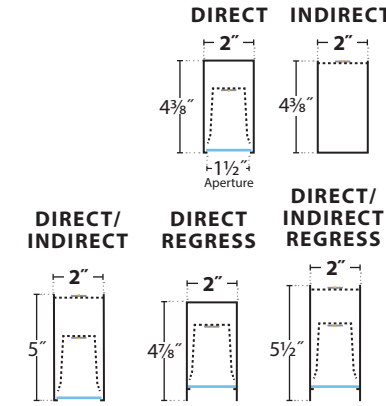
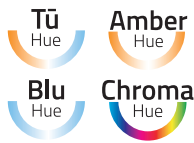

Lumen output may vary +/- 5%
Light Loss Factor (LLF) for CCTs other than 3500K:
 4000K +2%, 3000K -5%, 2700K -20%
 90 CRI -15% (3K, 3500K, 4K & 5K)
 ADC -2% LLF
 Louver LLF 30% White, 50% Silver, 70% Black

FLSH:		LO	MO	SO	HO
DIRECT:					
SAL	Lm/Ft	390	575	790	1000
BTW	Lm/Ft	415	610	845	1060
WWF	Lm/Ft	425	625	875	1100
WWG / PFL	Lm/Ft	400	600	825	1050
NGZ	Lm/Ft	450	675	950	1250
MGZ	Lm/Ft	425	625	875	1100
WGZ	Lm/Ft	450	675	950	1250
LGP	Lm/Ft	425	625	875	—
	W/Ft	3.8	5.6	7.8	10.5
INDIRECT:					
SYM	Lm/Ft	600	800	1050	1350
MCW	Lm/Ft	400	550	750	1000
SCW	Lm/Ft	575	875	1170	1450
SACW	Lm/Ft	500	750	1000	1200
	W/Ft	3.8	5.6	7.8	10.5
DIRECT / INDIRECT:					
	W/Ft	7.6	11.2	15.6	21



LUMEN CHART AT 3500K-80 CRI
 SEE PAGE 6 FOR REGRESS

SE-RIES	LENS POS.	LED COLOR	OUT-PUT	LENGTH	COLOR / LAMINATE	LAM. CAN-OPY COLOR	LOUVER COLOR	DISTRIBUTION	UP OP-TIONS	CIRCU-ITING	MOUNTING	CEILING TYPE	DRIVERS	OPTIONS & SENSORS
BPRO2-LIN														
BionicPro 2 Linear	FLSH Flush Lens	LED27 2700K (90CRI) LED3 3000K LED35 3500K LED4 4000K LED3-90 3000K (90CRI) LED35-90 3500K (90CRI) LED4-90 4000K (90CRI) LED5-90 5000K (90CRI)	LO Low MO Medium SO Standard HO High R (Row Length, 1" increments. Consult factory for custom lengths) SRL Sym-metric Row Length (See page 12) NOTE: Individual fixtures are NOT intended for row mounting	2' 3' 4' 5' 6' 7' 8'	TMW Textured Matte White (Standard) YGW Gloss White Y__ Pre-mium Color CC__ Custom Color LUXE METAL-LICS: YBZ Bronze YCP Copper Penny YGN Gold Nugget NOTE: For LUXE finishes, Stem and Canopy are White (TMW) unless specified otherwise. LAMINATE FINISHES (SPECIFY CAN-OPY COLOR IN NEXT COLUMN =>) LOK Vara Oak LEW Evreux Walnut LOG Oxi-dized Gold LOB Oxi-dized Black L__ Special Order Laminated (EXTENDED LEAD TIMES) NOTE: For Laminated finishes, Stem and Canopy are White (TMW) unless specified otherwise.	(SKIP THIS COLUMN IF LAMINATE FINISH IS NOT SELECTED) TMW Textured Matte White (Standard) YGW Gloss White Y__ Premium Color CC__ Custom Color LUXE METAL-LICS: YBZ Bronze YCP Copper Penny YGN Gold Nugget NOTE: For LUXE finishes, Stem and Canopy are White (TMW) unless specified otherwise.	(SKIP THIS COLUMN IF LOUVER IS NOT SELECTED) TMW Textured Matte White (Standard) YGW Gloss White Y__ Premium Color CC__ Custom Color LUXE METAL-LICS: YBZ Bronze YCP Copper Penny YGN Gold Nugget NOTE: All canopies painted White (TMW) unless specified otherwise.	CHOOSE DOWN -AND- UP DOWN: NW No Direct UP: NU No In-direct SAL Satin Lens BTW Batwing WWF Flat Wall Wash WWG Focal Glow Wall Wash PFL Perim-eter Room Fill NGZ Narrow Wall Graze MGZ Medium Wall Graze WGZ Wide Wall Graze LGP Low Glare Prisma-tic (NA HO)	TG Top Glow ADC Acrylic Dust Cover (Clear) Standard for SYM (Frosted) TGADC Top Glow with Acrylic Dust Cover UP OP-TIONS AVAIL-ABLE WITH ANY UP DISTRI-BUTION	SC Single Circuit (Down & Up will dim together) DC Dual Circuit (Needed if dimming Down separately from Up) VOLT-AGE UNV (120-277) 347 (Emergency battery requires remote driver box)	(SPECIFY CEILING TYPE IN NEXT COLUMN =>) CA48", 96" or 144" Aircraft Cable (Adjust-able) SURF Sur-face Mount (Direct only) RSC Rigid Stem Center SSC Swivel Stem Center (~45° of rotation) (SPECIFY MOUNTING LOCATION IN NEXT COLUMN =>) WMC (Chan-nel) .75" Tall Continuous Channel WMC2 (Channel) 2" Tall Continuous Channel WMU (Bracket) .5" Tall Bracket WMU1 (Bracket) 1" Tall Bracket WMU2 (Bracket) 2" Tall Bracket WM Direct to Wall WBx.x Wall Bracket (2"-6" in .5" increments, 3" standard if not specified)	CEILING TYPE: X1 T-Bar X3 Hard Ceiling X6 Slot Grid MOUNT-ING LOCA-TION: WALL (For Wall or Mullion Mount) SUR Ceiling WALL	ND Non-Dimming DM01 0-10v, 1% Dimming (Standard) LDE1 Hi-lume 1% EcoSystem LED (Soft fade on, fade-to-black dimming) ECO 1% 0-10v, EldoLED (Logarithmic dimming std) ECDA 1% DALI, EldoLED (Logarithmic dimming std) nLight-Air Acuity nLight Drivers (ECDA driver ONLY) nLight-Wired Acuity nLight Drivers (ECO driver ONLY, Requires Remote Driver) SOLO 0.1% 0-10v, EldoLED (Dim-to-dark, Logarithmic dimming std) SODA 0.1% DALI, EldoLED (Dim-to-dark, Logarithmic dimming std) STEP Signify Advance Step Dimming 2WIRE ELV/For-ward/Reverse Phase Driver PRUHUES: E10V 2 Channel Color Control EDALI 2 Channel Color Control EDMX Chroma-Hue or Static White	EMHE CA T20 Emergency Battery (1250 Delivered Lumens; CA Title 20 compliant, 2'-3' remote) ETS-DR Iota ETS-DR Emergency Transfer Switch EMC Emergency Circuiting FTR Feather WTW Asym-metric on Perpendicular Wall (NA HO or LGP) EBCP1G /2G Single / Dual Gang (Electrical Box Cover Plate/ Mud Ring) COS Custom On-Center Spacing for Wall/Surface Brackets SENSORS: (NA w/EDMX) 205 WattStopper PIR Occupancy 205-ON/OFF 205-STEP: Dim to 50% 205-DM: Dim to 1% (NA with DALI) ATHENA Lutron RF (Dim-to-Off Standard) LVOC** Lutron Vive (Occ & RF) LVRF** Lutron Vive (RF Only) **Requires Lutron driver NXSMP Hubble (occ) rES7 Daylight+(PIR Acoustic) (Occ) (nLight-Air) Part Number: rES7-PDT-180D-G2 nES7 Daylight+(PIR Acoustic) (Occ) LUX Philips DLR CORNERS: C2-60 Lit 60° C2-90 Lit 90° C2-120 Lit 120° C2-135 Lit 135° C3T Lit 90° 3-Way: T C3Y Lit 120° 3-Way: Y C4T Lit 90° 4-Way: + C4X Lit 45°-135° 4-Way: X C8I Lit Inside 2-Plane C8O Lit Outside 2-Plane 90° LOUVERS AVAILABLE (CONSULT FACTORY FOR OTHER ANGLES) LRT Linear to Recessed Transition (Straight rows only) DWNLT Downlights

BionicPro2 | Linear Downlights



PRUDENTIAL LTG.

PRULITE.COM 213.746.0360



Want Downlights without a lens?

Specify 'NW' No Direct + desired indirect + Downlight option in last column
 NW-____-DWNLT



One Row
(BPRO2 & 3)



Two Rows
(BPRO4 & 5)

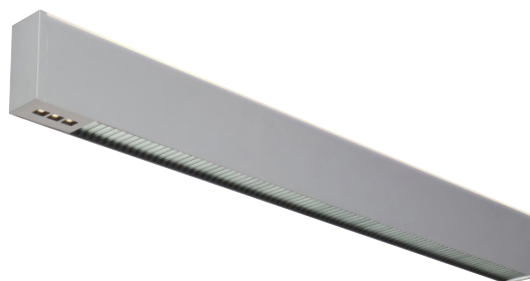

LEFT
 (Start) Placement
 (BPRO2 Linear shown with Louver)



MID
 Middle of Row Placement
 (BPRO4 Recessed shown with Flush Lens)

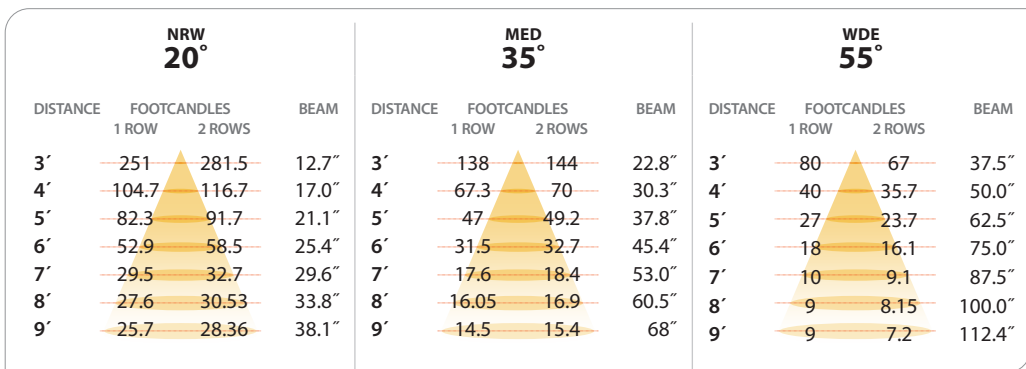
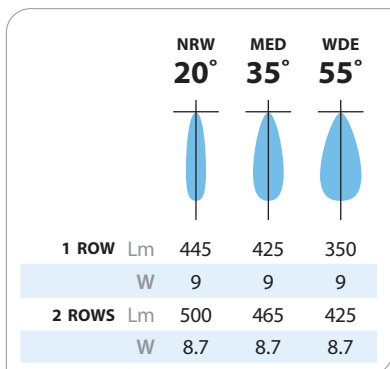

SERIES	QUANTITY	LOCATION	CCT	DISTRIBUTION	COLOR	VOLT-AGE	DRIVERS
DWN-LT							
Down-light	SPECIFY DOWNLIGHT QUANTITY PER FIXTURE/ROW Maximum One (1) Downlight Every 4' 16' Row = 4 Downlights 30' Row = 7 Downlights	MID One Downlight in Middle of Fixture LT One Downlight on Left (Start) RT One Downlight on Right (End) LT-RT Two Downlights on Ends LT-MID Two Downlights on Left and Middle MID-RT Two Downlights on Middle and End MOD Downlight Location(s) per Specs	LED3-90 3000K-90CRI (Standard) LED35-90 3500K-90CRI LED4-90 4000K-90CRI NOTES: - NA 2700K, 5000K - Only 1 Output Offered	NRW Narrow 20° Beam MED Medium 35° Beam WDE Wide 55° Beam	TMW Textured Matte White (Standard) YGW Gloss White Y_ Premium Color CC Custom Color LUXE METALLICS: YBZ Bronze YCP Copper Penny YGN Gold Nugget	UNV (120-277) 347	DM01 0-10v, 1% Dimming (Standard) LDE1 Hi-lume 1% EcoSystem LED (Soft fade on, fade-to-black dimming) ECO 1% 0-10v, EldoLED (Logarithmic dimming std) ECDA 1% DALI, EldoLED (Logarithmic dimming std) SOLO 0.1% 0-10v, EldoLED (Dim-to-dark, Logarithmic dimming std) SODA 0.1% DALI, EldoLED (Dim-to-dark, Logarithmic dimming std)



FLSH:

SATIN LENS

MEDIUM OUTPUT:

BPRO2-LIN-FLSH-LED35-MO-SAL

2300 Delivered Lumens
23 Watts
101 lm/w
3500 CCT
1.18 Spacing Criteria

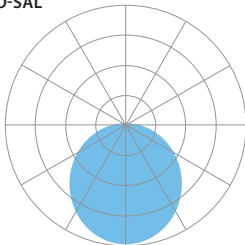

Zonal Lumen Summary:
0-90 = 100%

852

Vertical Angle	0°	25°	45°	65°	90°
0°	850	850	850	850	850
5°	841	842	840	846	852
15°	795	797	798	808	817
25°	715	718	723	739	750
35°	616	618	625	644	657
45°	504	504	513	531	547
55°	382	384	392	407	424
65°	257	259	267	281	295
75°	134	135	143	155	168
85°	21	23	28	38	48
90°	0	0	0	0	0

BATWING

MEDIUM OUTPUT:

BPRO2-LIN-FLSH-LED35-MO-BTW

2445 Delivered Lumens
23 Watts
107 lm/w
3500 CCT
1.82 Spacing Criteria

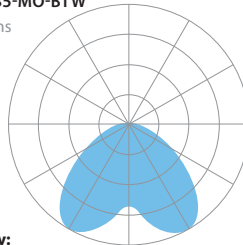

Zonal Lumen Summary:
0-90 = 100%

1019

Vertical Angle	0°	25°	45°	65°	90°
0°	601	601	601	601	601
5°	651	644	622	606	598
15°	894	856	743	615	552
25°	1019	987	843	604	478
35°	568	708	993	1053	1030
45°	676	702	707	467	328
55°	466	487	514	355	266
65°	287	300	320	244	204
75°	141	148	160	141	133
85°	27	28	36	42	47
90°	0	0	0	0	0

UGR17
WELL Building Standard

LOW GLARE PRISMATIC

STANDARD OUTPUT:

BPRO2-LED35-SO-LGP

3695 Delivered Lumens
32 Watts
117 lm/w
3500 CCT

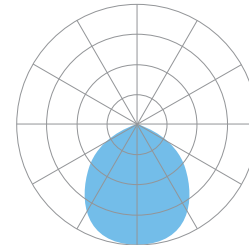

Zonal Lumen Summary:
0-90 = 100%

2384

Vertical Angle	0°	25°	45°	65°	90°
0°	2384	2384	2384	2384	2384
5°	2336	2337	2339	2364	2385
15°	1834	1894	2042	2208	2280
25°	1165	1239	1494	1886	2068
35°	774	812	990	1440	1757
45°	547	568	662	982	1366
55°	357	368	418	601	924
65°	193	200	222	300	446
75°	88	92	99	124	162
85°	27	27	27	29	33
90°	0	0	0	0	0

UGR16
WELL Building Standard

NARROW WALL GRAZER

STANDARD OUTPUT:

BPRO2-FLSH-LED35-LO-4-NGZ-DM01

3844 Delivered Lumens
32 Watts
119 lm/w
3500 CCT

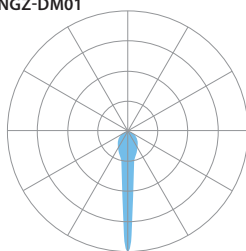

Zonal Lumen Summary:
0-90 = 100%

5736

Vertical Angle	0°	45°	90°	135°	180°
0°	5736	5736	5736	5736	5736
5°	2309	2966	5114	3196	2262
15°	1291	1320	4834	1306	1264
25°	1003	1166	4076	1177	1041
35°	731	868	2820	903	779
45°	526	620	1726	657	569
55°	360	423	969	459	402
65°	223	259	469	290	260
75°	107	125	179	147	134
85°	23	30	34	42	40
90°	0	0	0	0	0

MEDIUM WALL GRAZER

LOW OUTPUT:

BPRO2-FLSH-LED35-LO-4-MGZ-DM01

1722 Delivered Lumens
15 Watts
114 lm/w
4000 CCT

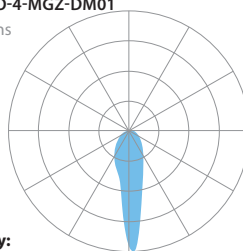

Zonal Lumen Summary:
0-90 = 100%

1608

Vertical Angle	0°	45°	90°	135°	180°
0°	1608	1608	1608	1608	1608
5°	1514	1564	1640	1701	1611
15°	726	770	928	1354	1506
25°	505	531	616	928	1293
35°	358	375	437	654	989
45°	256	267	304	453	652
55°	177	183	203	281	355
65°	112	116	125	153	171
75°	58	61	65	75	82
85°	15	17	18	22	24
90°	0	0	0	0	0

WIDE WALL GRAZER

STANDARD OUTPUT:

BPRO2-FLSH-LED35-LO-4-WGZ-DM01

3789 Delivered Lumens
32 Watts
118 lm/w
3500 CCT

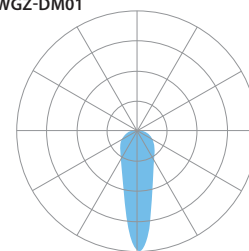

Zonal Lumen Summary:
0-90 = 100%

2744

Vertical Angle	0°	45°	90°	135°	180°
0°	2744	2744	2744	2744	2744
5°	2352	2477	2663	2668	2568
15°	1493	1753	2505	1938	1622
25°	1058	1266	2198	1379	1153
35°	771	930	1768	1015	850
45°	558	669	1279	735	623
55°	386	457	819	508	439
65°	240	282	456	321	284
75°	114	135	203	164	149
85°	22	30	42	43	45
90°	0	0	0	0	0



FLSH:

FLAT WALL WASH

LOW OUTPUT:

BPRO2-FLSH-LED35-LO-4-WWF

1724 Delivered Lumens
15 Watts
110 lm/w
3500 CCT

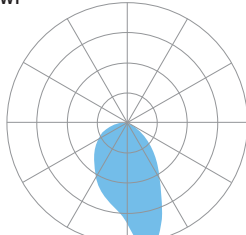

1004

Zonal Lumen Summary:

0-90 = 100%

Vertical Angle	0°	25°	45°	65°	90°
	90°	0	0	0	0
85°	16	16	19	22	24
75°	60	62	77	82	82
65°	121	128	160	170	159
55°	209	222	276	315	291
45°	334	355	427	509	455
35°	504	528	608	714	592
25°	709	739	836	859	694
15°	996	1004	988	886	762
5°	908	901	867	832	796
0°	796	796	796	796	796
5°	720	725	734	760	796
15°	604	615	639	684	762
25°	486	496	528	596	694
35°	399	405	422	486	592
45°	316	320	331	365	455
55°	236	237	238	246	291
65°	164	162	154	146	159
75°	93	92	84	77	82
85°	23	25	24	23	24
90°	0	0	0	0	0
Vertical Angle	180°	202.5°	225°	247.5°	270°

FOCAL GLOW WALL WASH / PERIMETER FILL

LOW OUTPUT:

BPRO2-FLSH-LED35-LO-4-WWG/PFL

1656 Delivered Lumens
15 Watts
110 lm/w
3500 CCT

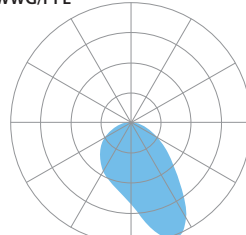

893

Zonal Lumen Summary:

0-90 = 100%

Vertical Angle	0°	25°	45°	65°	90°
	90°	0	0	0	0
85°	17	17	21	24	26
75°	62	67	86	90	85
65°	132	143	189	180	147
55°	241	261	340	314	226
45°	394	427	532	473	328
35°	618	660	725	604	604
25°	870	874	826	678	525
15°	893	871	796	694	595
5°	722	716	689	662	632
0°	634	634	634	634	634
5°	565	570	578	601	632
15°	487	491	499	529	595
25°	436	438	441	458	525
35°	385	384	382	387	432
45°	329	326	318	311	328
55°	262	259	244	225	226
65°	186	182	164	145	147
75°	102	102	89	81	85
85°	24	26	25	24	26
90°	0	0	0	0	0
Vertical Angle	180°	202.5°	225°	247.5°	270°



NW (NO DIRECT) — UP:

SYMMETRIC

STANDARD OUTPUT:

BPRO2-LED35-SO-NW-SYM-ADC

4332 Delivered Lumens

33 Watts

132 lm/w

3500 CCT

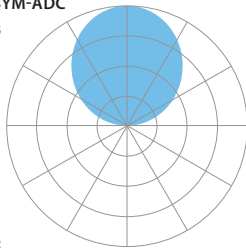

Zonal Lumen Summary:

90-180 = 100%

1782

Vertical Angle	0°	22.5°	45°	67.5°	90°
90°	0	0	0	0	0
95°	61	62	65	67	69
105°	225	229	238	249	252
115°	436	444	465	473	483
125°	706	715	723	734	750
135°	976	980	993	1018	1034
145°	1248	1255	1267	1292	1308
155°	1494	1499	1502	1522	1537
165°	1668	1670	1667	1682	1699
175°	1755	1755	1750	1765	1782
180°	1770	1770	1770	1770	1770

SOFT CEILING WASH

STANDARD OUTPUT:

BPRO2-LED35-SO-NW-SCW

4639 Delivered Lumens

33 Watts

143 lm/w

3500 CCT

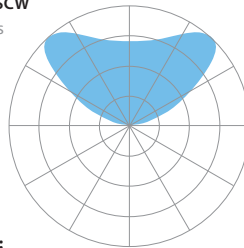

Zonal Lumen Summary:

90-180 = 100%

1584

Vertical Angle	0°	22.5°	45°	67.5°	90°
90°	0	0	0	0	0
95°	102	123	161	136	48
105°	367	409	463	344	198
115°	755	804	824	539	369
125°	1270	1283	1117	701	539
135°	1584	1492	1179	823	700
145°	1484	1381	1138	921	851
155°	1279	1220	1102	1005	978
165°	1149	1130	1094	1074	1073
175°	1114	1111	1106	1114	1123
180°	1117	1117	1117	1117	1117

MEDIUM CEILING WASH

STANDARD OUTPUT:

BIOPRO-LIN-SO-MCW

3115 Delivered Lumens

32 Watts

97 lm/w

3500 CCT

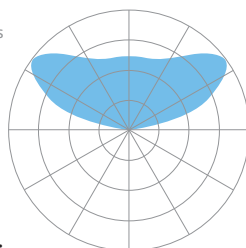

Zonal Lumen Summary:

90-180 = 100%

1138

Vertical Angle	0°	22.5°	45°	67.5°	90°
90°	0	0	0	0	0
95°	41	45	57	33	1
105°	464	475	344	146	92
115°	852	787	495	539	204
125°	1060	916	573	256	296
135°	973	843	601	469	442
145°	811	739	1138	544	530
155°	709	683	619	600	598
165°	667	657	642	635	640
175°	659	657	655	653	656
180°	664	664	664	664	664

SOFT ASYMMETRIC CEILING WASH

STANDARD OUTPUT:

BPRO2-LIN-SO-SACW

4073 Delivered Lumens

33 Watts

125 lm/w

3500 CCT

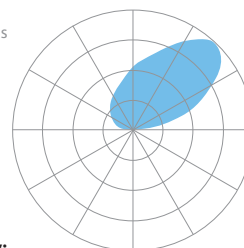

Zonal Lumen Summary:

90-180 = 100%

2106

Vertical Angle	0°	22.5°	45°	67.5°	90°
90°	0	0	0	0	0
95°	341	366	345	222	46
105°	939	946	853	503	174
115°	1475	1458	1268	697	320
125°	1906	1856	1504	848	463
135°	2106	1962	1499	946	599
145°	1906	1745	1373	1011	724
155°	1544	1443	1245	1046	828
165°	1268	1230	1149	1042	904
175°	1069	1048	1018	985	945
180°	936	936	936	936	936



REG.5:

SATIN LENS

STANDARD OUTPUT:
BPRO2-LIN-REG.5-LED35-SO-SAL

2610 Delivered Lumens
33 Watts
80 Lm/W
3500 CCT

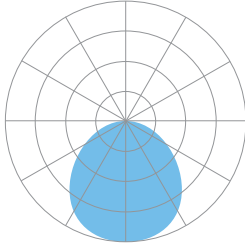

MEDIUM WALL GRAZER

STANDARD OUTPUT:
BPRO2-LIN-REG.5-LED35-SO-4-MGZ

3210 Delivered Lumens
31 Watts
108 Lm/W
3500 CCT
19° FWHM

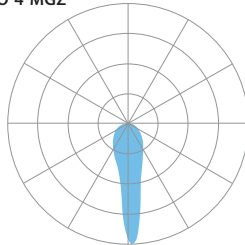

PERIMETER FILL

STANDARD OUTPUT:
BPRO2-LIN-REG.5-LED35-SO-4-PFL

3029 Delivered Lumens
33 Watts
96 Lm/W
3500 CCT

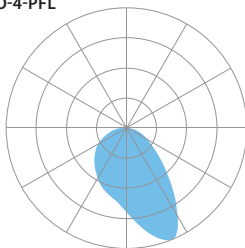

UPTO **108** LPW

REG.5:		LO	MO	SO	HO
SAL	Lm/Ft	300	460	650	800
BTW	Lm/Ft	340	500	715	900
WWF	Lm/Ft	375	560	750	975
WWG/PFL	Lm/Ft	375	560	750	975
MGZ	Lm/Ft	400	590	800	1040
	W/Ft	4	6	8	10.5

LUMEN CHART AT 3500K-80 CRI

Consult factory for Louver IES: marketing@prulite.com

LUMEN MAINTENANCE

L70 — 200,000+ Hours
L90 — 100,000+ Hours (LO, MO & SO)
L90 — 60,000+ Hours (HO)

LED SYSTEM LED modules and drivers are field replaceable.

PROG (OPTIONAL) Programmable light output. Specify desired lumens or watts per linear foot.

LABELS CSA and ETL damp labeled and I.B.E.W. manufactured.

ELECTRICAL Must specify LED dimming controls. LED fixtures have constant current driver(s) with less than 20% THD when loaded to a minimum of 60%. Drivers sink a maximum of 6mA per driver. DM01 LED drivers are 0-10V dimmable and are compatible with most 0-10V wall slide dimmers and direct 0-10V analog signal dimmers. Max driver size 1.65" w x 1.25" h.

CONSTRUCTION

Housing Extruded aluminum housing and side wall >25% PC recycled, 100% recyclable.

Lens Seamless lens up to 200'. Consult factory for longer lengths. Polymer, 100% recyclable.

Weight 3.5 lbs/ft

MOUNTING Surface mounted to walls or ceilings, wall spacer, wall bracket to wall, suspended by cable.

WARRANTY Single-source, 5 year limited warranty covers standard components and construction.

FINISH COLORS

STANDARD:



PREMIUM:

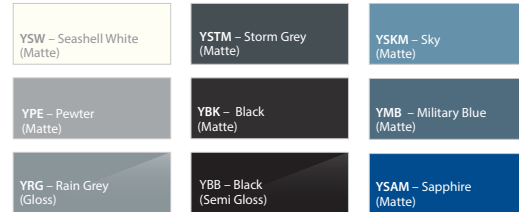

LUXE METALLICS:



LAMINATE FINISHES:

Choose from one of our Premium Colors with no set-up fee. For paint chip samples, please email: info@prulite.com

STANDARD:

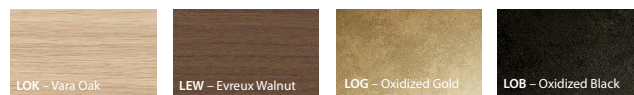

SPECIAL ORDER (EXTENDED LEAD TIMES):

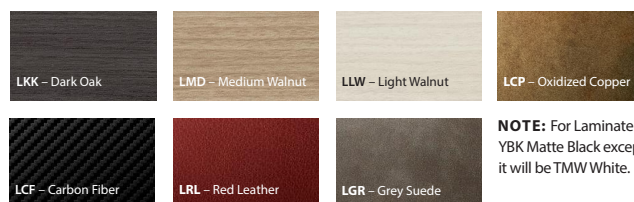

NOTE: For Laminate finishes Stem is YBK Matte Black except for LOK and LLW it will be TMW White.



CAST ALUMINUM END CAPS

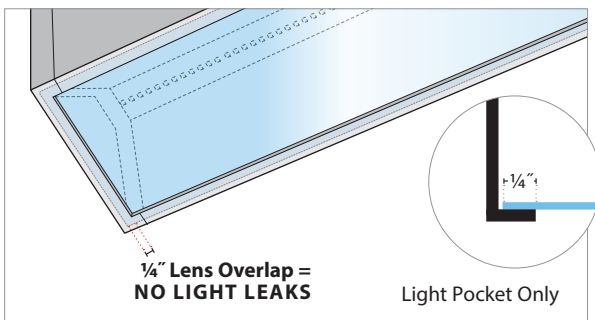

ADJOINING DETAILS

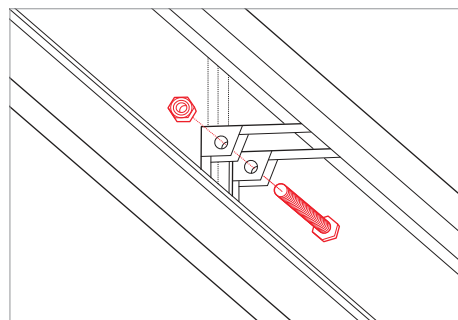

DISTRIBUTIONS

DOWN:

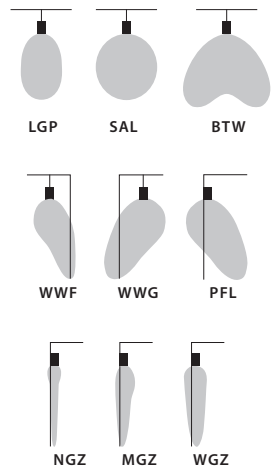

UP:

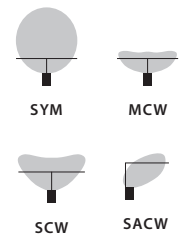

EBCP — ELECTRICAL BOX COVER PLATE

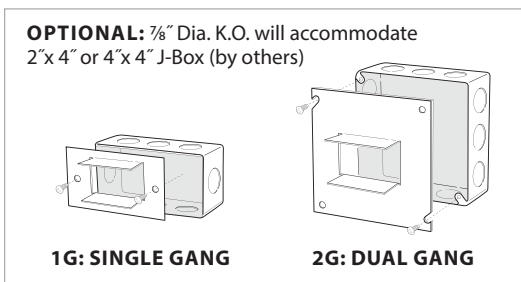

CANOPY DETAIL



WALL CROSS SECTIONS

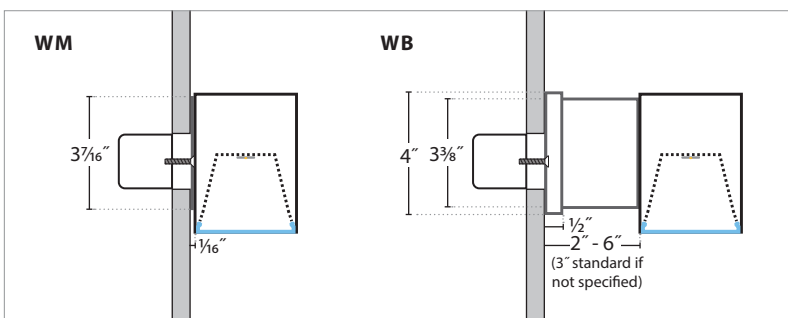

FIXTURE SIZE VARIES



Why Channels?

Channels provide maximum flexibility in mounting points on the ceiling/wall (drilled in the field into structure).
 2 mounting points per channel required, all channels are the length of the fixture. .75" Channel accommodates SOOW cord (8 foot, 6 conductor cord), 2" Channel accommodates liquitite Flex with sealed connectors (6' long 6' conductor cord).

WMC — WALL

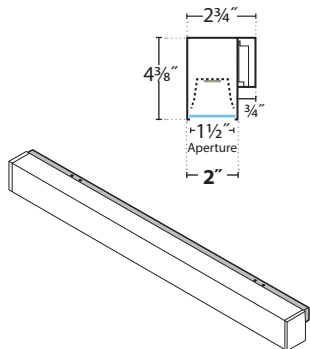

WMC2 — WALL

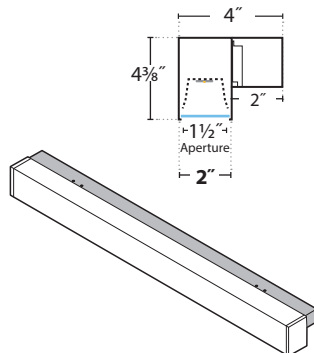

WMC — SURFACE

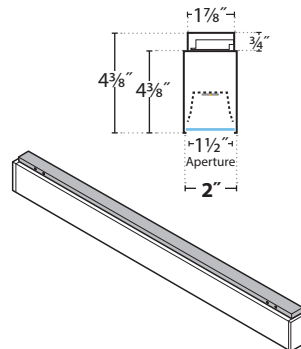

WMC2 — SURFACE

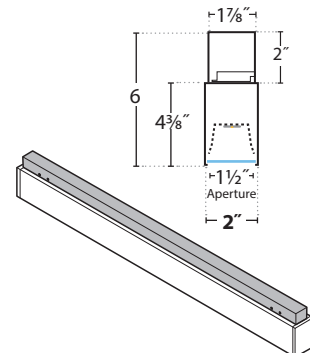

Why Brackets?

Clean look. Two options.

1. Installed at our standard dimensions.
2. COS (Custom on-center spacing) — Provide dimensions and our factory will install bracket cleats at provided dimensions.



WMU — WALL

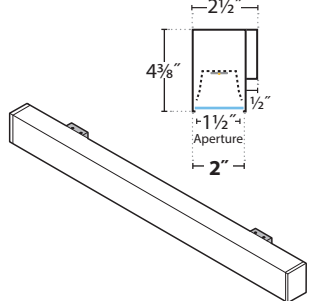

WMU1 — WALL

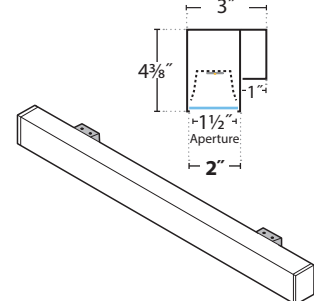

WMU2 — WALL

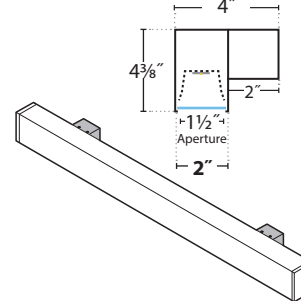

WMU — SURFACE

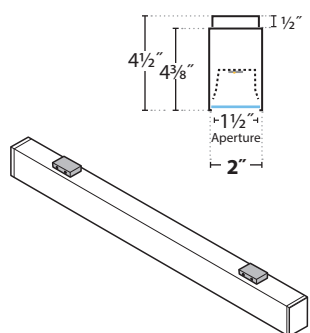

WMU1 — SURFACE

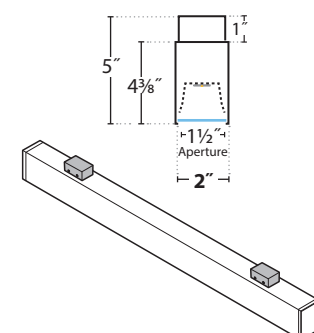

WMU2 — SURFACE

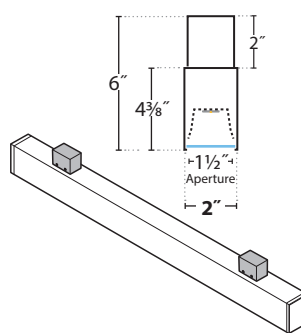

CA — CABLE MOUNT

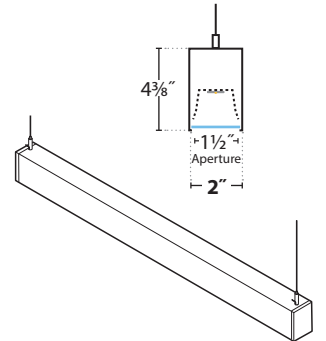

R/SSC — STEM MOUNT

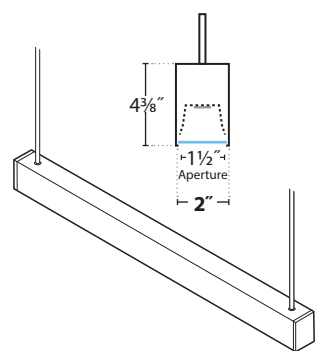



CABLE (CA) — MOUNTING

NOTE: 2' ROW FIXTURES NOT AVAILABLE

○ POWER FEED

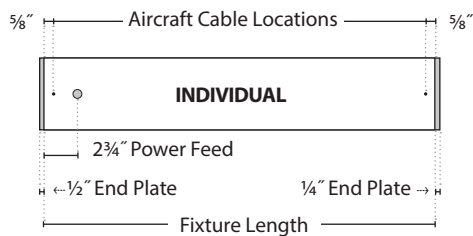
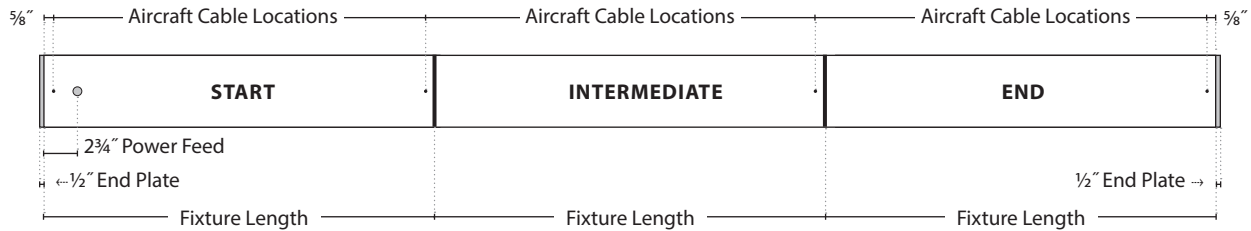

	AIRCRAFT CABLE LOCATIONS		
	All	Start / Individual	Intermediate / End
2'	24"	22 3/4"	24"
3'	36"	34 3/4"	36"
4'	48"	46 3/4"	48"
5'	60"	58 3/4"	60"
6'	72"	70 3/4"	72"
7'	84"	82 3/4"	84"
8'	96"	94 3/4"	96"

CA — CABLE

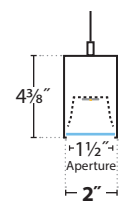

STEM (RSC/SSC) — MOUNTING

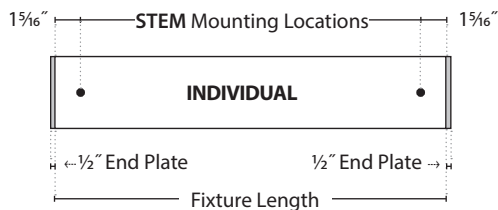
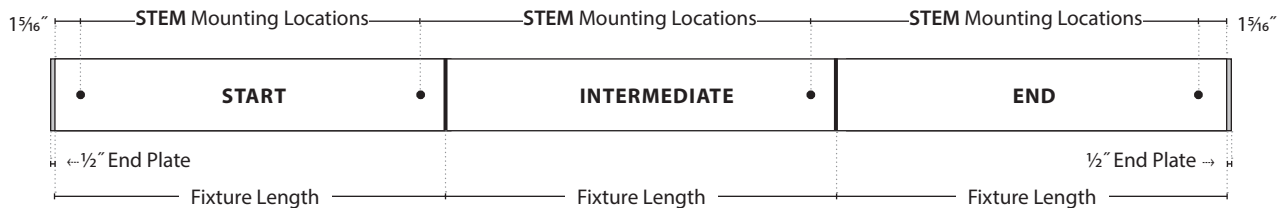

	AIRCRAFT CABLE LOCATIONS		
	All	Start / Individual	Intermediate / End
2'	24"	21 3/4"	24"
3'	36"	33 3/4"	36"
4'	48"	45 3/4"	48"
5'	60"	57 3/4"	60"
6'	72"	69 3/4"	72"
7'	84"	81 3/4"	84"
8'	96"	93 3/4"	96"

R/SSC — STEM

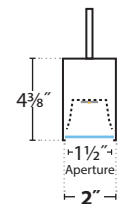



SURFACE (SURF) — MOUNTING

● POWER FEED

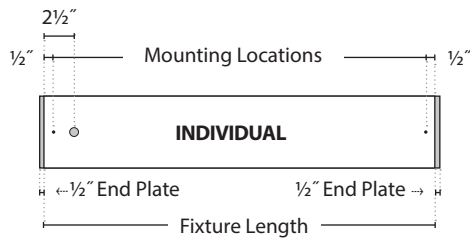
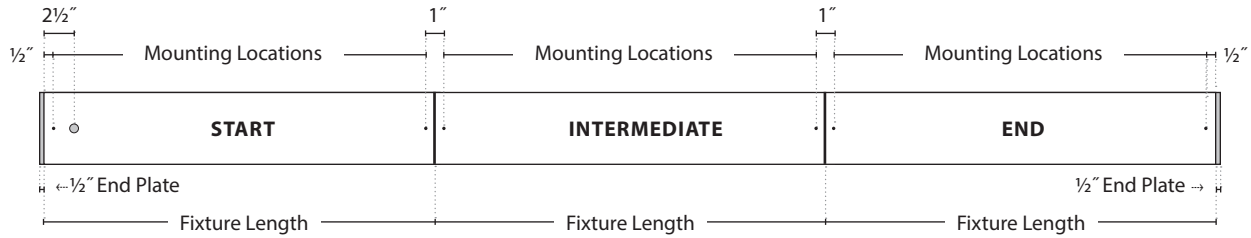

	FIXTURE LENGTHS	MOUNTING LOCATIONS
2'	24"	23"
3'	36"	35"
4'	48"	47"
5'	60"	59"
6'	72"	71"
7'	84"	83"
8'	96"	95"

WALL (WM) — MOUNTING

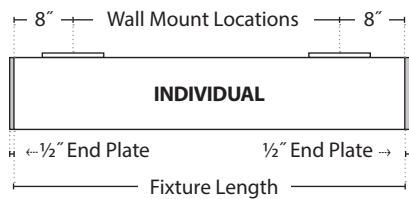
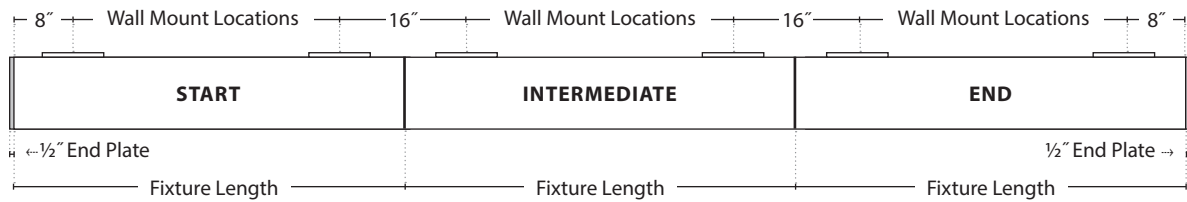

	FIXTURE LENGTHS	WALL MOUNT LOCATIONS
2'	24"	8"
3'	36"	20"
4'	48"	32"
5'	60"	44"
6'	72"	56"
7'	84"	68"
8'	96"	80"



WMC/WMC2 (CHANNELS): WALL — MOUNTING

NOTE: 2' ROW FIXTURES NOT AVAILABLE

○ POWER FEED

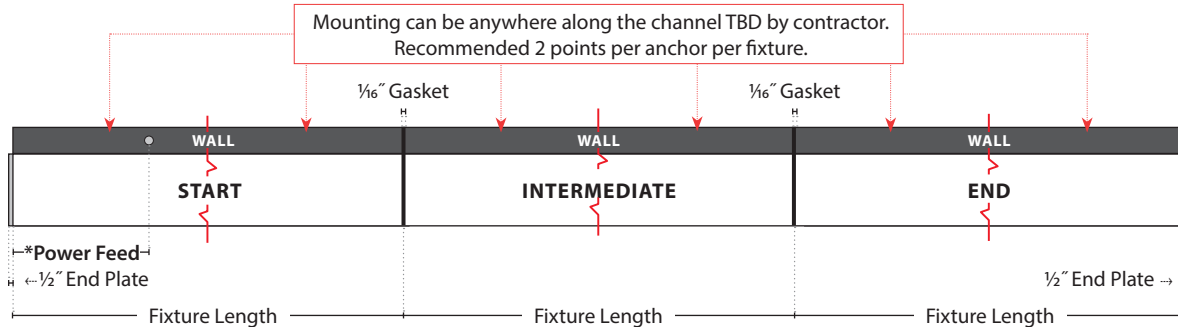

INDIVIDUAL (2'):

Mounting can be anywhere along the channel TBD by contractor. Recommended 2 points per anchor per fixture.

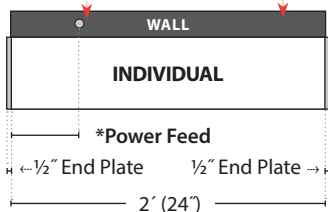

Mounting can be anywhere along the channel TBD by contractor. Recommended 2 points per anchor per fixture.

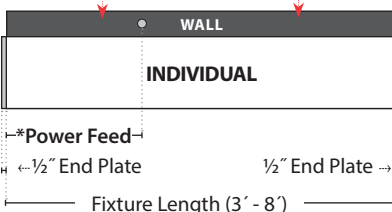

	FIXTURE LENGTHS	
	*Power Feed	All
2'	4"	24"
3'	10"	36"
4'	10"	48"
5'	10"	60"
6'	36"	72"
7'	42"	84"
8'	48"	96"

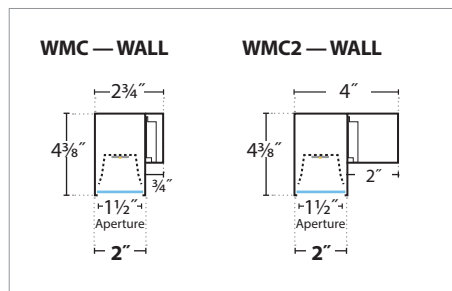



WMC/WMC2 (CHANNELS): SURFACE — MOUNTING

NOTE: 2' ROW FIXTURES NOT AVAILABLE

○ POWER FEED

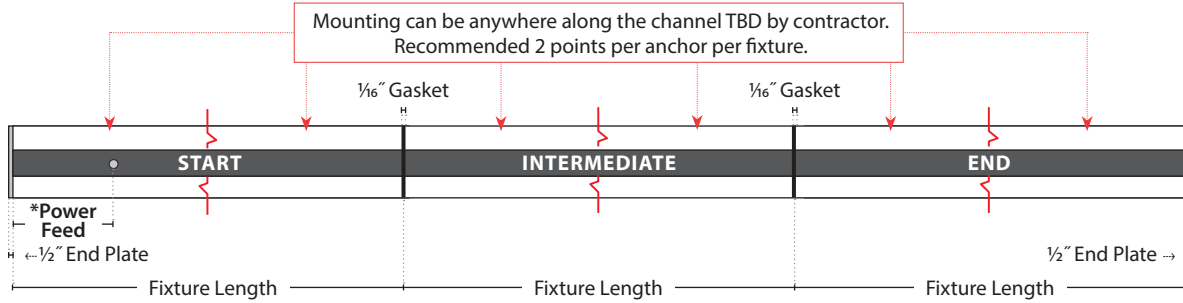

INDIVIDUAL (2'):

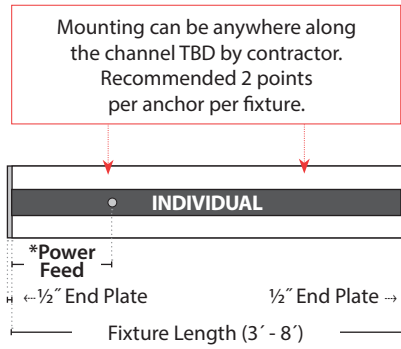
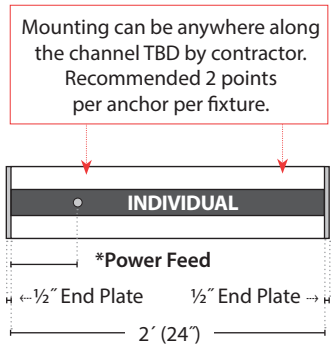

	FIXTURE LENGTHS	
	*Power Feed	All
2'	4"	24"
3'	6"	36"
4'	6"	48"
5'	6"	60"
6'	36"	72"
7'	42"	84"
8'	48"	96"

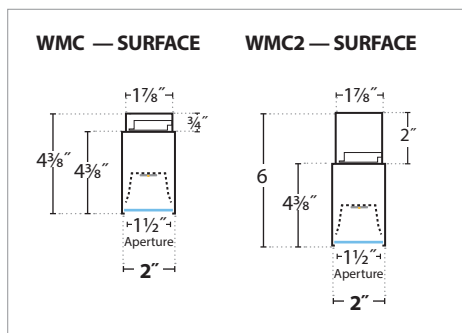



WMU/WMU1/WMU2 (BRACKETS): WALL — MOUNTING

NOTE: 2' ROW FIXTURES NOT AVAILABLE

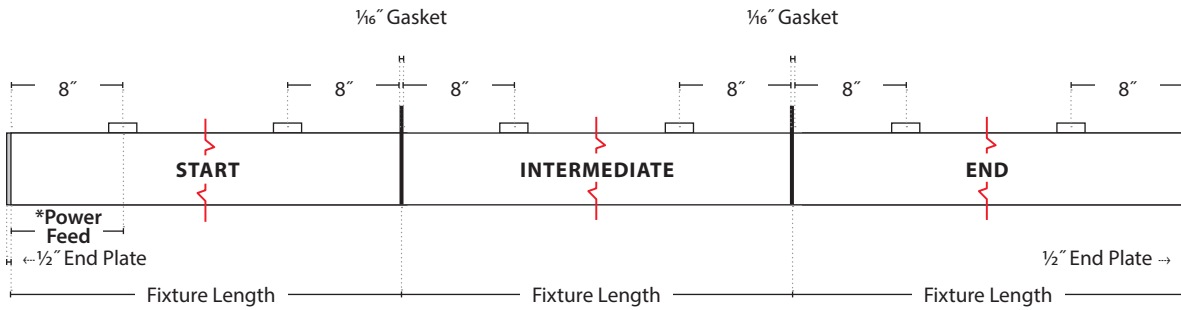

INDIVIDUAL (2'):

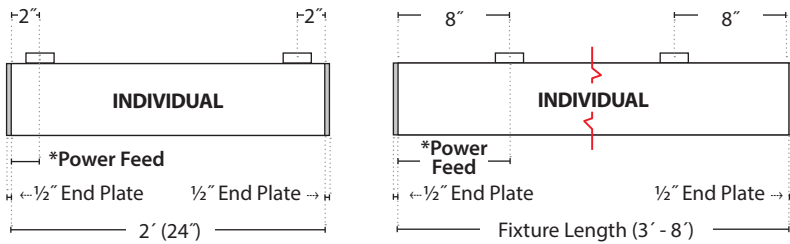

	FIXTURE LENGTHS		MOUNTING LOCATIONS		COS (Custom On-Center Spacing)
	*Power Feed	All	Start / Intermediate / End	Individual	
2'	2"	24"	—	20"	Customer to provide on-center mounting dimensions, PRU will pre-drill and mount Brackets
3'	8"	36"	20"	20"	
4'	8"	48"	32"	32"	
5'	8"	60"	44"	44"	
6'	8"	72"	56"	56"	
7'	8"	84"	68"	68"	
8'	8"	96"	80"	80"	

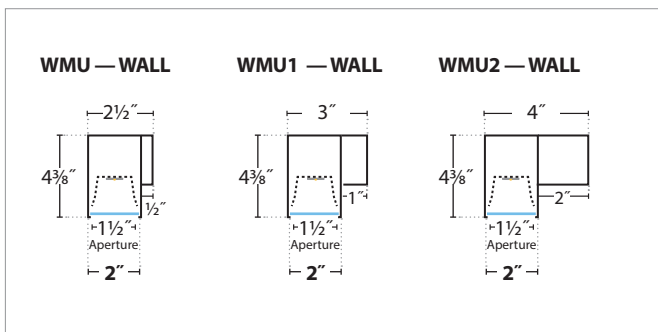



WMU/WMU1/WMU2 (BRACKETS): SURFACE — MOUNTING

NOTE: 2' ROW FIXTURES NOT AVAILABLE

○ POWER FEED

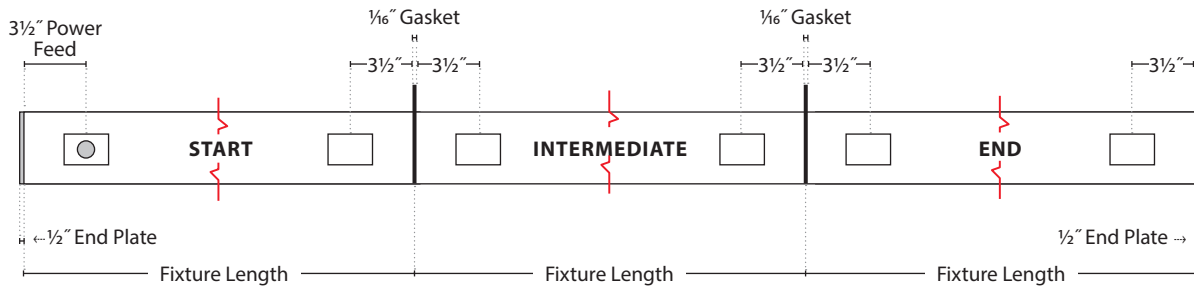

INDIVIDUAL (2'):

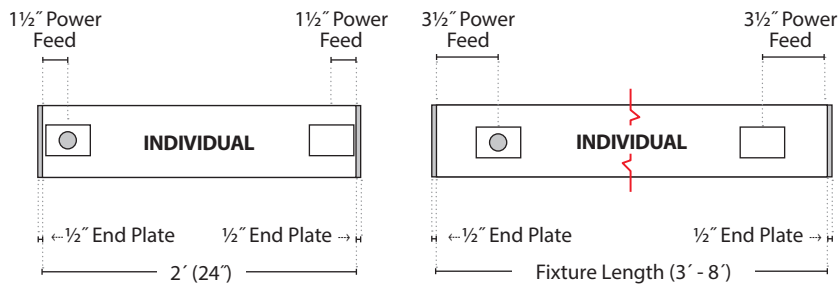

	FIXTURE LENGTHS	MOUNTING LOCATIONS		
	All	Start / Intermediate / End	Individual	COS (Custom On-Center Spacing)
2'	24"	—	21"	Customer to provide on-center mounting dimensions, PRU will pre-drill and mount Brackets
3'	36"	29"	29"	
4'	48"	41"	41"	
5'	60"	53"	53"	
6'	72"	65"	65"	
7'	84"	77"	77"	
8'	96"	89"	89"	

WMU — SURFACE

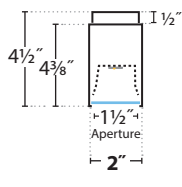

WMU1 — SURFACE

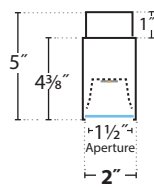

WMU2 — SURFACE

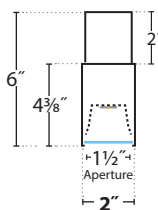



CORNERS

C2-60:

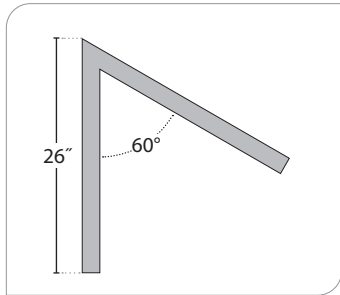

C2-90:

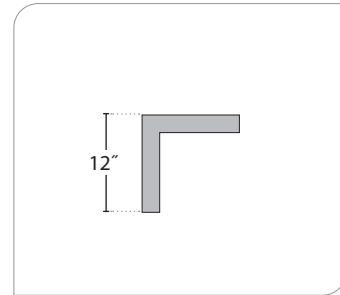

C2-120:

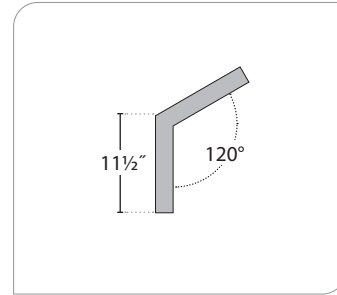

C2-135:

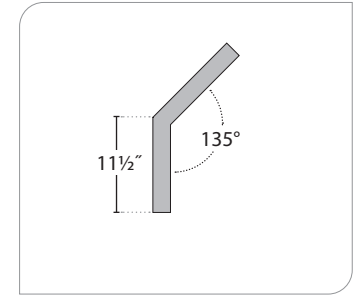

C3T:

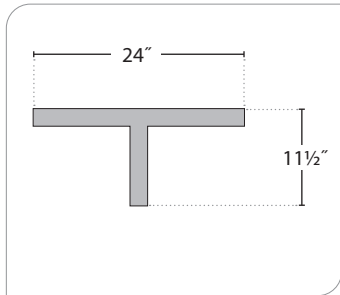

C3Y:

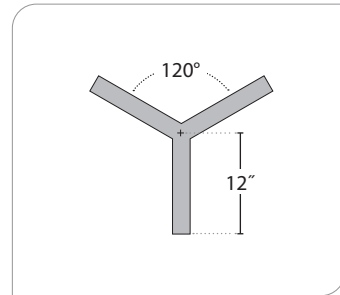

C4T:

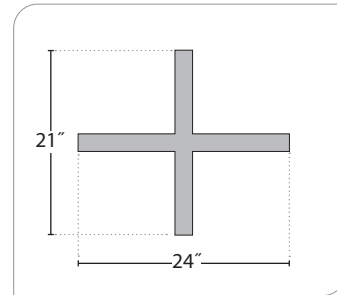

C4X:

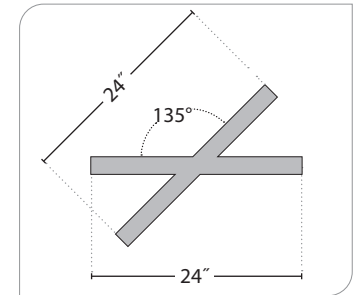

C8I:

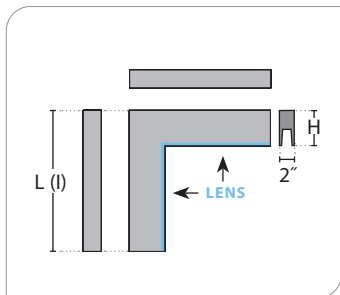

C8O:

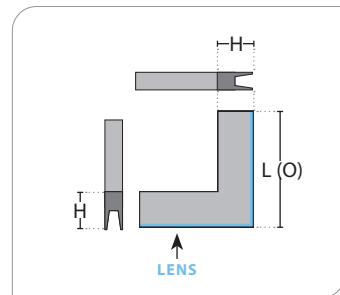

BODY TYPE	DIM "H"	DIM "L" (I)	DIM "L" (O)
Direct Flush	4 3/8"	16 3/8"	12"
Direct Regress	4 7/8"	16 3/8"	12 1/2"
Direct/Indirect Flush	5"	17"	12"
Direct/Indirect Regress	5 1/2"	17"	12 1/2"

SENSOR PLATE



LOUVER DETAIL





FTR END OF ROW FEATHERING

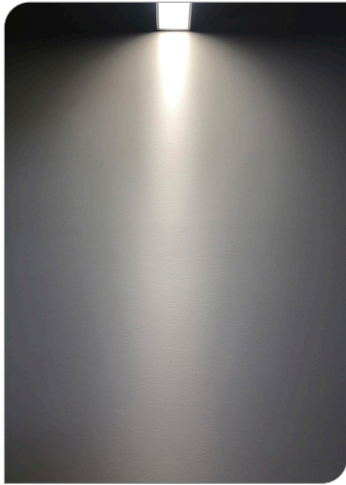

Wall to wall (WTW) fixtures can project strong lighting distributions on perpendicular wall which some find undesirable.

Medium Wall Graze (MGZ) shown above.

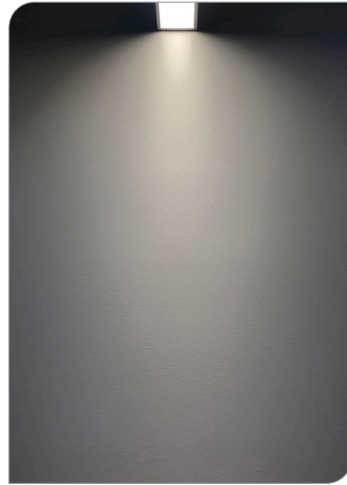

Feather (FTR) softens distributions on perpendicular walls.

Medium Wall Graze (MGZ) shown above with FTR.

LGP LOW GLARE PRISMATIC LENS



TOP VIEW



WELL OPTION 1B,
FIXTURE UGR 16 OR LESS

Low Glare Prismatic lens has a dynamic 'prismatic stripe' that 'follows the viewer' and offers a sense of depth. The narrow distribution has low glare (UGR) and meets WELL UGR of 16 or lower. It utilizes the FTR Diffuser (see below).

NOTE: Our Batwing lens also meets WELL UGR of 16 or less (BioPro 3-4-5). NA with HO output.

FTR (FEATHERING DIFFUSER) DETAIL

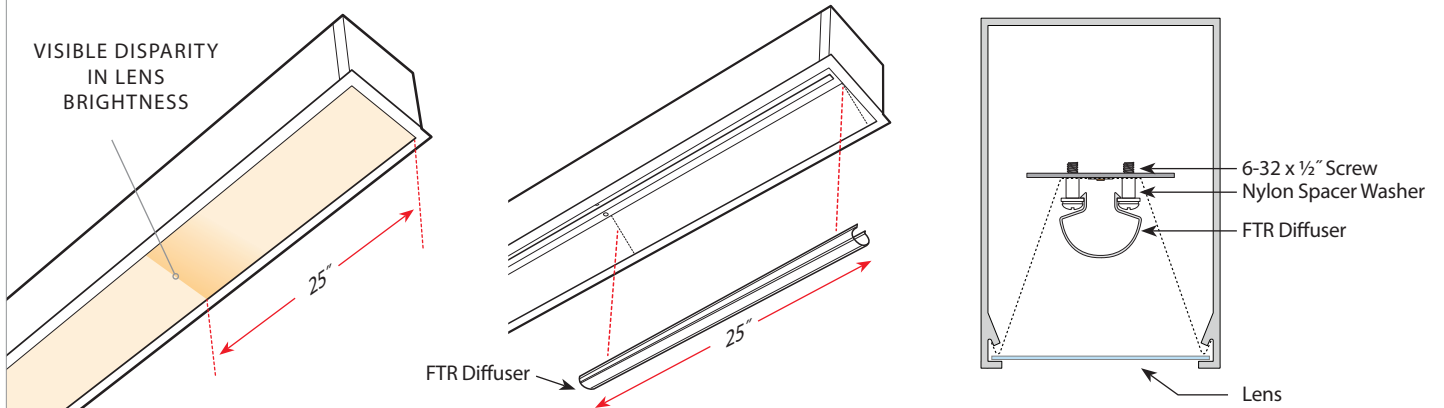

NOTE: Using FTR creates a visible disparity in lens brightness when viewed from directly below. FTR is NOT available dual-sided on two corners 5' or less.



ROW BUILDER

18' STANDARD ROW LENGTH:

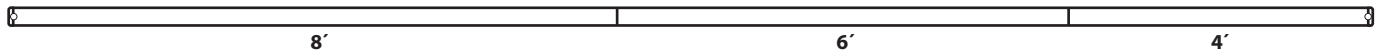

18' SYMMETRIC ROW LENGTH (SRL):

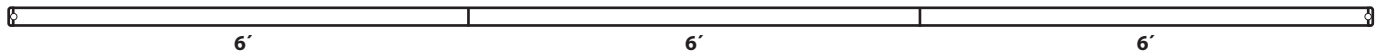

STANDARD

ROW LENGTH		
9'	5+4	5FT STR + 4FT END
10'	6+4	6FT STR + 4FT END
11'	7+4	7FT STR + 4FT END
12'	8+4	8FT STR + 4FT END
13'	8+5	8FT STR + 5FT END
14'	8+6	8FT STR + 6FT END
15'	8+7	8FT STR + 7FT END
16'	8+8	8FT STR + 8FT END
17'	8+5+4	8FT STR + 5FT INT + 4FT END
18'	8+6+4	8FT STR + 6FT INT + 4FT END
19'	8+7+4	8FT STR + 7FT INT + 4FT END
20'	8+8+4	8FT STR + 8FT INT + 4FT END
21'	8+8+5	8FT STR + 8FT INT + 5FT END
22'	8+8+6	8FT STR + 8FT INT + 6FT END
23'	8+8+7	8FT STR + 8FT INT + 7FT END
24'	8+8+8	8FT STR + 8FT INT + 8FT END
25'	8+8+5+4	8FT STR + 8FT INT + 5FT INT + 4FT END
26'	8+8+6+4	8FT STR + 8FT INT + 6FT INT + 4FT END
27'	8+8+7+4	8FT STR + 8FT INT + 7FT INT + 4FT END
28'	8+8+8+4	8FT STR + (2) 8FT INT + 4FT END
29'	8+8+8+5	8FT STR + (2) 8FT INT + 5FT END
30'	8+8+8+6	8FT STR + (2) 8FT INT + 6FT END
31'	8+8+8+7	8FT STR + (2) 8FT INT + 7FT END
32'	8+8+8+8	8FT STR + (2) 8FT INT + 8FT END
33'	8+8+8+5+4	8FT STR + (2) 8FT INT + 5FT INT + 4FT END
34'	8+8+8+6+4	8FT STR + (2) 8FT INT + 6FT INT + 4FT END
35'	8+8+8+7+4	8FT STR + (2) 8FT INT + 7FT INT + 4FT END
36'	8+8+8+8+4	8FT STR + (3) 8FT INT + 4FT END
37'	8+8+8+8+5	8FT STR + (3) 8FT INT + 5FT END
38'	8+8+8+8+6	8FT STR + (3) 8FT INT + 6FT END
39'	8+8+8+8+7	8FT STR + (3) 8FT INT + 7FT END
40'	8+8+8+8+8	8FT STR + (3) 8FT INT + 8FT END
41'	8+8+8+8+5+4	8FT STR + (3) 8FT INT + 5FT INT + 4FT END
42'	8+8+8+8+6+4	8FT STR + (3) 8FT INT + 6FT INT + 4FT END
43'	8+8+8+8+7+4	8FT STR + (3) 8FT INT + 7FT INT + 4FT END
44'	8+8+8+8+8+4	8FT STR + (4) 8FT INT + 4FT END
45'	8+8+8+8+8+5	8FT STR + (4) 8FT INT + 5FT END
46'	8+8+8+8+8+6	8FT STR + (4) 8FT INT + 6FT END
47'	8+8+8+8+8+7	8FT STR + (4) 8FT INT + 7FT END
48'	8+8+8+8+8+8	8FT STR + (4) 8FT INT + 8FT END
49'	8+8+8+8+8+5+4	8FT STR + (4) 8FT INT + 5FT INT + 4FT END
50'	8+8+8+8+8+6+4	8FT STR + (4) 8FT INT + 6FT INT + 4FT END

SYMMETRICAL

ROW LENGTH		
9'	3+3+3	3FT STR + 3FT INT + 3FT END
10'	5+5	5FT STR + 5FT END
11'	4+3+4	4FT STR + 3FT INT + 4FT END
12'	6+6	6FT STR + 6FT END
13'	4+5+4	4FT STR + 5FT INT + 4FT END
14'	7+7	7FT STR + 7FT END
15'	5+5+5	5FT STR + 5FT INT + 5FT END
16'	8+8	8FT STR + 8FT END
17'	6+5+6	6FT STR + 5FT INT + 6FT END
18'	6+6+6	6FT STR + 6FT INT + 6FT END
19'	6+7+6	6FT STR + 7FT INT + 6FT END
20'	8+4+8	8FT STR + 4FT INT + 8FT END
21'	8+5+8	8FT STR + 5FT INT + 8FT END
22'	8+6+8	8FT STR + 6FT INT + 8FT END
23'	8+7+8	8FT STR + 7FT INT + 8FT END
24'	8+8+8	8FT STR + 8FT INT + 8FT END
25'	6+4+5+4+6	6FT STR + 4FT INT + 5FT INT + 4FT INT + 6FT END
26'	8+5+5+8	8FT STR + (2) 5FT INT + 8FT END
27'	6+5+5+5+6	6FT STR + (3) 5FT INT + 6FT END
28'	8+6+6+8	8FT STR + (2) 6FT INT + 8FT END
29'	8+4+5+4+8	8FT STR + 4FT INT + 5FT INT + 4FT INT + 8FT END
30'	8+7+7+8	8FT STR + (2) 7FT INT + 8FT END
31'	8+5+5+5+8	8FT STR + (3) 5FT INT + 8FT END
32'	8+8+8+8	8FT STR + (2) 8FT INT + 8FT END
33'	8+6+5+6+8	8FT STR + 6FT INT + 5FT INT + 6FT INT + 8FT END
34'	8+6+6+6+8	8FT STR + 6FT INT + 6FT INT + 6FT INT + 8FT END
35'	8+6+7+6+8	8FT STR + 6FT INT + 7FT INT + 6FT INT + 8FT END
36'	8+8+4+8+8	8FT STR + 8FT INT + 4FT INT + 8FT INT + 8FT END
37'	8+8+5+8+8	8FT STR + 8FT INT + 5FT INT + 8FT INT + 8FT END
38'	8+8+6+8+8	8FT STR + 8FT INT + 6FT INT + 8FT INT + 8FT END
39'	8+8+7+8+8	8FT STR + 8FT INT + 7FT INT + 8FT INT + 8FT END
40'	8+8+8+8+8	8FT STR + (3) 8FT INT + 8FT END
41'	8+6+4+5+4+6+8	8FT STR + 6FT INT + 4FT INT + 5FT INT + 4FT INT + 6FT INT + 8FT END
42'	8+8+5+5+8+8	8FT STR + 8FT INT + (2) 5FT INT + 8FT INT + 8FT END
43'	8+6+5+5+5+6+8	8FT STR + 6FT INT + (3) 5FT INT + 6FT INT + 8FT END
44'	8+8+6+6+8+8	8FT STR + 8FT INT + (2) 6FT INT + 8FT INT + 8FT END
45'	8+8+4+5+4+8+8	8FT STR + 8FT INT + 4FT INT + 5FT INT + 4FT INT + 8FT INT + 8FT END
46'	8+8+7+7+8+8	8FT STR + 8FT INT + (2) 7FT INT + 8FT INT + 8FT END
47'	8+8+5+5+5+8+8	8FT STR + 8FT INT + (3) 5FT INT + 8FT INT + 8FT END
48'	8+8+8+8+8+8	8FT STR + (4) 8FT INT + 8FT END
49'	8+8+6+5+6+8+8	8FT STR + 8FT INT + 6FT INT + 5FT INT + 6FT INT + 8FT INT + 8FT END
50'	8+8+6+6+6+8+8	8FT STR + 8FT INT + (3) 6FT INT + 8FT INT + 8FT END



BionicPro2 Batwing Vs. Top 2" Competitor (Satin Lens)

SINGLE OFFICE

BionicPro2

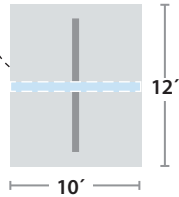
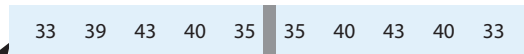

Top Competitor

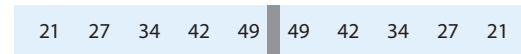

	BionicPro2	Competitor
LPW	105	86
SPACING CRITERIA	1.8	1.0
MAX/MIN	2.1	3.5
W/SQ. FT.	.65	.6
FC AVERAGE	31	29

9' ceiling .85 l/f BionicPro2—8w/ft Competitor—7w/ft Footcandles at 30" working plane

OPEN OFFICE

BionicPro2

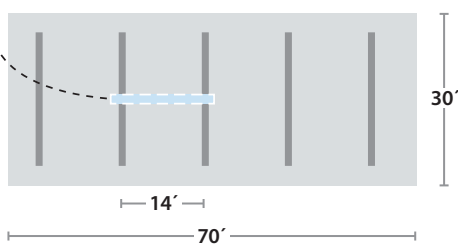
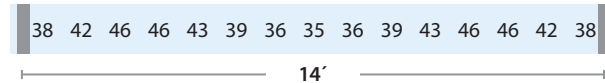

Top Competitor



	BionicPro2	Competitor
LPW	108	86
SPACING CRITERIA	1.8	1.0
MAX/MIN	2.3	3.7
MAX/MIN BETWEEN ROWS	1.3	2.6
W/SQ. FT.	.36	.45
FC AVERAGE	33	29

9' ceiling .85 l/f BionicPro2—5.7/ft Competitor—7w/ft Footcandles at 30" working plane



Smooth, flat wall washing (WWF)

Our patent-pending TruBeam™ optics redirect light in an ideal flat wall wash for smooth, even illumination.

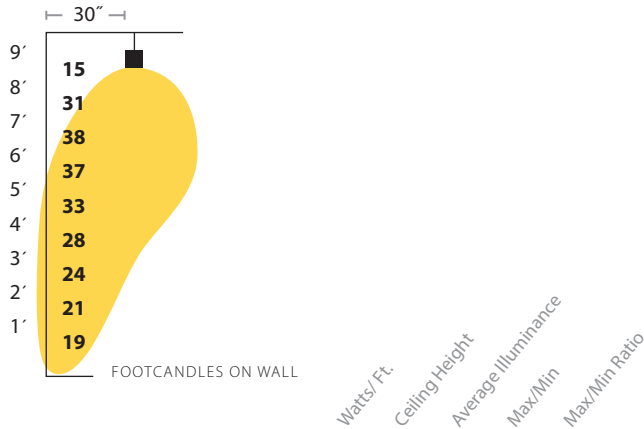

Medium Output 600 lumens/ft	6	9'	36 fc	50/15	3.3
--------------------------------------	---	----	--------------	-------	-----

Focal glow wall washing (WWG)

Pique interest by giving works of art 'pop' — more light at eye level

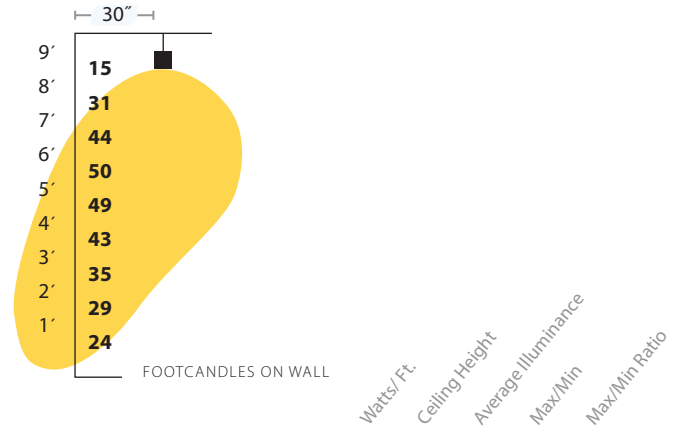

Medium Output 600 lumens/ft	6	9'	36 fc	50/15	3.3
--------------------------------------	---	----	--------------	-------	-----

Perimeter Fill (PFL)

Wash a corridor in light from one side of the perimeter. Our Perimeter Fill is ideal for hospital corridors where a 50 fc average is needed.

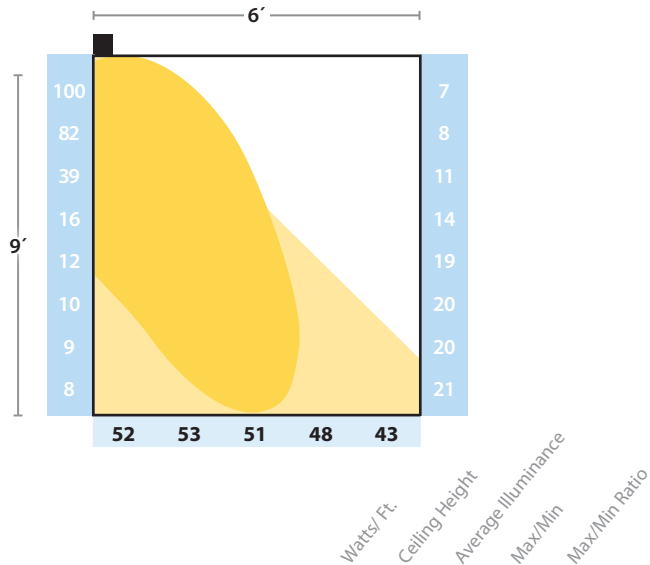

High Output 1050 lumens/ft	1.75	10'	50 fc	53/43	1.2
-------------------------------------	------	-----	--------------	-------	-----

Medium Wall Graze (MGZ)

Wall grazing performance often better just off a wall.

DIRECT TO WALL (WM) WALL BRACKET (WB)

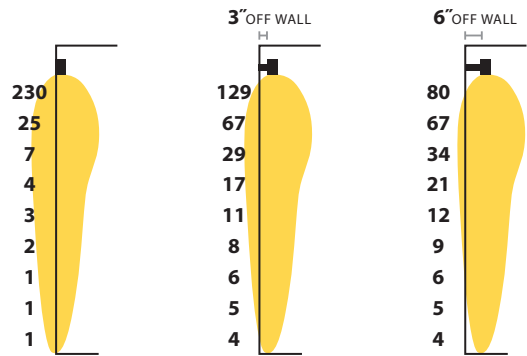

See perimeter specs

USE WB WALL BRACKET FOR BETTER PERFORMANCE THAN FLUSH TO WALL



Soft Ceiling Wash (SCW)

SINGLE OFFICE OR OTHER SMALL CEILING

Hung 18" below ceiling

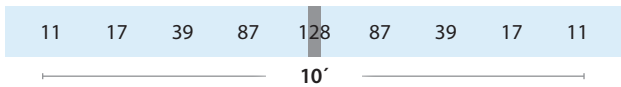
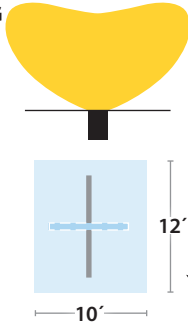

Medium Ceiling Wash (MCW)

SINGLE OFFICE OR OTHER SMALL CEILING

Hung 18" below ceiling

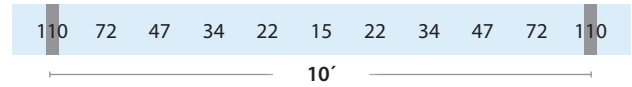
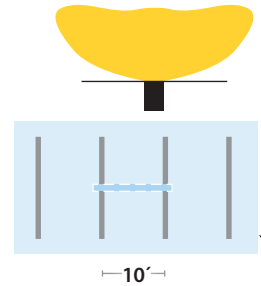

BionicPro to Bionic/P23-43 Optics Crossing Matrix

DOWNLIGHT:

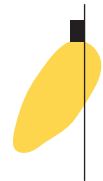
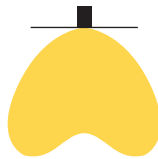
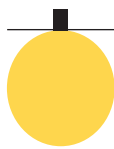

	Satin	Batwing	Flat Wall Wash	Focal Glow Wall Wash	Perimeter Fill
BionicPro	SAL	BTW	WWF	WWG	PFL
Bio2 / P23 = BionicPro3	SAL	MBW	MWW/D1W	—	MWW/D1R
Bionic4 / P43 = BionicPro4	SAL	ABW/D1X	—	AWL/D1W	AWL/D1R

WWG = PFL
Lens aimed away from wall

UPLIGHT:

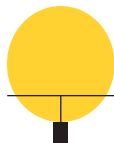

	Symmetric	Hard Ceiling Wash	Medium Ceiling Wash	Soft Ceiling Wash	Asymmetric Ceiling Wash
BionicPro	SYM	HCW NA BionicPro2	MCW	SCW	SACW
Bio2 / P23 = BionicPro3	SYM	CW	CW	—	ACW
Bionic4 / P43 = BionicPro4	SYM	CW	CW	—	—



Stairwell

Our Perimeter Room Fill (PFL) and Asymmetric Ceiling Wash (SACW) are ideal when paired for stairwells.

BPRO2-LIN-PFL-SACW

STAIRWELL 1

a.

18	22	24	22	18
22	25	28	25	22

b.

22	25	28	25	22
18	22	24	22	18
17	20	23	20	17

STAIRWELL 2

c.

18	22	24	22	18
22	25	28	25	22

15	23	32	28	26	23
16	25	31	27	23	19
16	26	31	27	21	17
16	25	28	25	20	16
13	22	22	20	18	16
11	18	20	17	14	13

d.

22	25	28	25	22
18	22	24	22	18
17	20	23	20	17

STAIRWELL 3

e.

19	21	23	21	19
20	23	27	23	20

BPRO2-LIN-FLSH-LED35-SO-SO-4'-PFL-SACW

11.2 watts per linear ft.

.9 LLF

Typically installed with occupancy sensor

Watts/ Sq. Ft.
Average Illuminance Landings
Average Illuminance Walls
Max/Min Landings
Max/Min Walls

Standard Output - 1825 lm/ft	.7	22fc	11fc	2	1.8
------------------------------	----	------	------	---	-----



WIRING DIAGRAMS
SPEC



PRUDENTIAL LTG.

PRULITE.COM 213.746.0360

Lumen Outputs:

		BLUHUE, TUHUE, TUHUE2, AMBERHUE			
DIRECT:		LO	MO	SO	HO*
SAL	Lm/Ft	205	385	550	715
BTW/ WWG/ PFL	Lm/Ft	215	395	565	730
LGP/ WWF/ MGZ	Lm/Ft	225	405	580	750
	W/Ft	3.8	5.6	7.8	10.5
INDIRECT:		LO	MO	SO	HO*
SYM	Lm/Ft	360	480	630	800
HCW	Lm/Ft	150	300	450	575
SCW	Lm/Ft	350	525	700	870
SACW	Lm/Ft	300	450	600	720
	W/Ft	3.8	5.6	7.8	10.5

** TU2 + AMB NOT AVAILABLE HO / CHROMAHUE ONLY AVAILABLE ON HO



Prudential Lighting's **TuHue** Tunable White provides warm to cool white light simulating sunlight. Controlling the light source color temperature offers differing design aesthetics with potential benefits via circadian rhythm support. Blue light for alertness while warm light conveys tranquility.

- 2700K-6500K or 2200K-5000K.
- Adjust the color temperate and brightness separately.
- Simulates warm to cool to warm transition of sunlight.

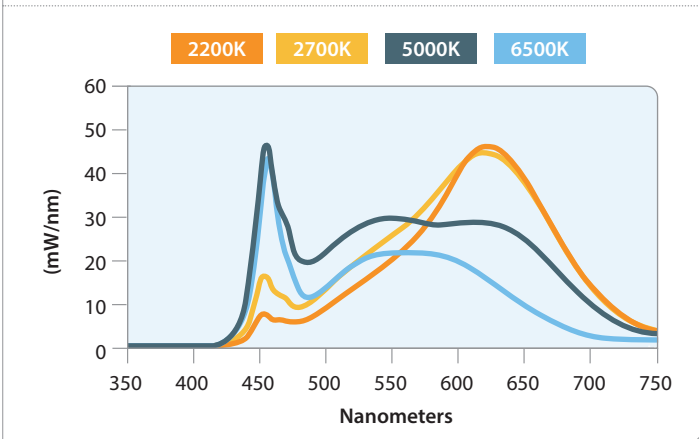
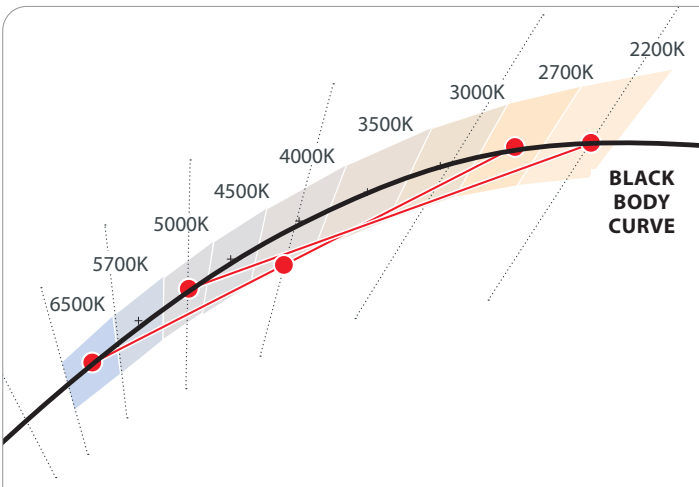

BluHue BIOS SkyBlue™ circadian LED lighting brings the benefits of blue skies inside. Newly discovered blue-sky receptors in our eyes drive improved daytime alertness, mood, brain function, and strengthens circadian rhythms leading to overall better health and well-being.

- Circadian rhythms play an integral role in physical and mental health.
- BluHue BIOS SkyBlue pinpoints peak 490nm sensitivity to provide the most benefit from an electric light source.
- At night, simply dim the lights to remove SkyBlue™ wavelengths (specify "Blu_D" to dim Cyan SkyBlue spike separately [night model]).

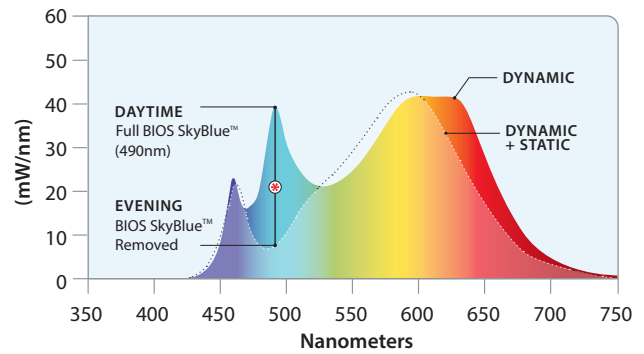

100%-75%

DYNAMIC SkyBlue™ Dims 100%-0%

Dynamic dimming results in subtle CCT shift warmer

75%-0%

DYNAMIC + STATIC Light Dims 100%-0%



AmberHue is Prudential Lighting's Warm Dim offering. It transitions bright white light to warm amber light as brightness is dimmed, reflecting sunlight's transitioning from intense blue midday light to a dimmed golden hue near sunset, also reminiscent of soft glowing candlelight.

- Warm Dim 2200K-5000K.
- Color temperature warms as the luminaire is dimmed.
- Calm, relaxing mood communicated – hospitality, residential feel.

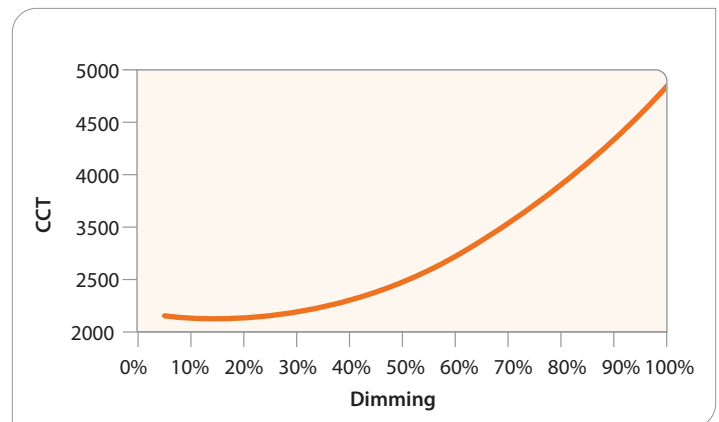



ChromaHue offers a vibrant full gamut of colors for seemingly endless architectural interior applications. Rich color-changing light offers tremendous design flexibility while white light can be achieved with the White chip, or mixing of Red, Green and Blue light. No longer just for the entertainment industry, ChromaHue can be intermixed on BionicPro luminaires for mood-creating indirect illumination combined with static white direct light.

- RGBW LED array (Red, Green, Blue, White) with full spectrum color and white light on the black body curve.
- Four-channel control, DMX drivers.
- Any color point within the triangle can be reached by setting the proper output levels for each individual red, green, blue and white channels.
- Standard DMX is one zone with one XLR drop at start, one XLR return at the end.

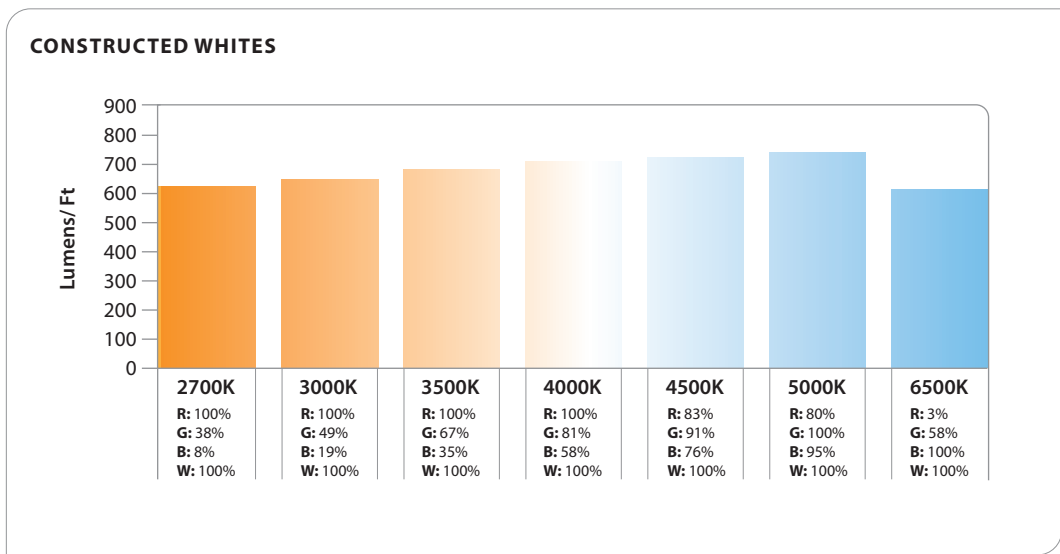
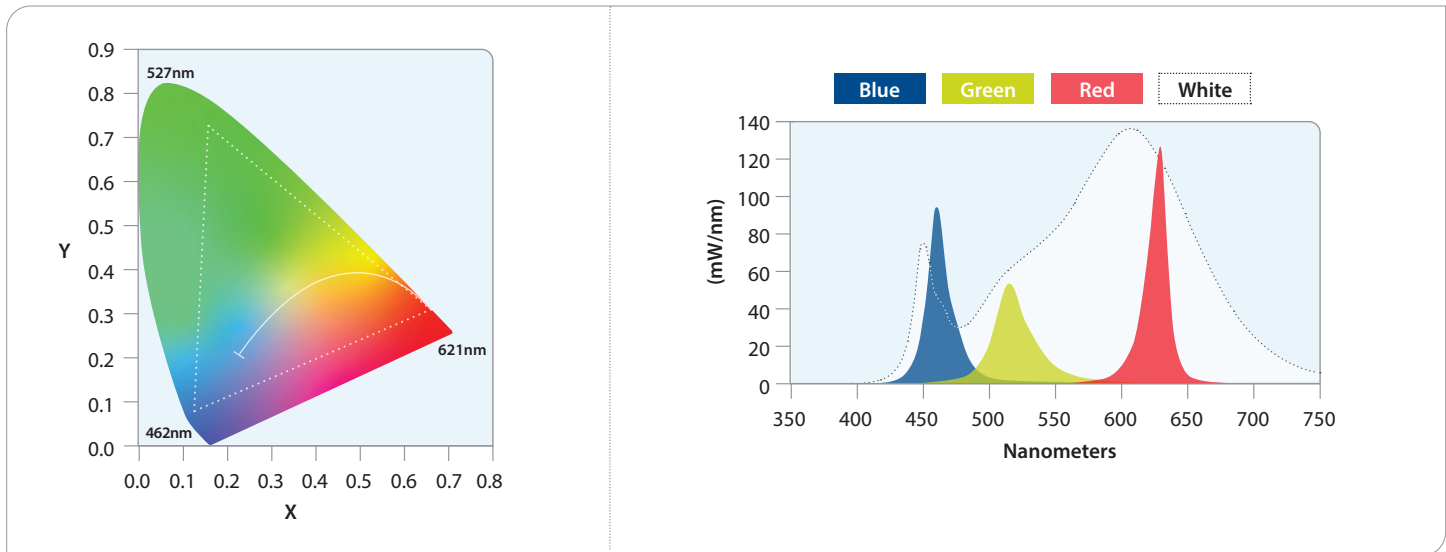



LM79 & TM30 DATA:

	MEASURED CCT	MEASURED LUMENS	CRI	R9	DuV	SPD	TM30 — COLOR VECTOR	TM30 — COLOR DISTORTION
LED27	2680	80%	93	58	0.001		89 Rf	97 Rg
LED3	3042	95%	82	6	0.001		81 Rf	92 Rg
LED3-90	3016	85%	93	61	0.000		88 Rf	96 Rg
LED35	3482	100%	82	3	0.002		81 Rf	92 Rg
LED35-90	3417	85%	93	67	0.000		88 Rf	96 Rg
LED4	3952	102%	82	4	0.003		81 Rf	92 Rg
LED4-90	3882	85%	92	67	0.003		87 Rf	96 Rg
LED5-90	4889	85%	94	84	0.002		86 Rf	95 Rg











LM79 & TM30 DATA:

		MEASURED CCT	MEASURED LUMENS	CRI	R9	LED27	SPD	TM30 — COLOR VECTOR
BH3S&D	bioS 3000K	2779	2758	87	81	0.003		
	BH3D SKY BLUE DIMMED	2715	2425	82	3	0.002		
BH35S&D	bioS 3500K	3245	2919	85	87	0.003		
	BH35D SKY BLUE DIMMED	3061	2502	83	7	0.001		
BH4&D	bioS 4000K	3624	2993	85	86	0.004		
	BH4D SKY BLUE DIMMED	3388	2585	83	5	0.002		
TH	LED27	2684	2456	92	57	0.0001		
	LED65	6061	3292	82	-1	0.006		
TH2	LED22	2209	2112	92	52	0.0005		
	LED50	4796	2789	93	77	0.004		
CH	2700K	2632	2469	82	50	0.003		
	3500K	3388	2585	83	5	0.002		
	4000K	3977	2682	83	29	0.003		
	5000K	5233	2823	84	21	0.003		



SENSORS

				
<p>205: Wattstopper</p>	<p>LVOC: Lutron Occupancy /Daylight Sensor</p>	<p>LVRF: Lutron Vive Control Node</p>	<p>NXSMP: Hubbell Occupancy /Daylight Sensor</p>	<p>ATHENA</p>
<p>Low voltage PIR fixture integrated occupancy sensor.</p>	<p>Measures light in the space (daylighting) while detecting people moving within an area using passive infrared to determine occupancy.</p> <p>Controls the lights to balance the light level in the space, combining convenience, exceptional energy savings, and ease of installation.</p>	<p>Provides wireless control of the fixture when neither occupancy nor daylight sensing is needed.</p>	<p>Hubbell Integrated/embedded networked lighting control, luminaire-level lighting control, LLLC.</p> <p>PIR motion sensor for automatic On/Off control.</p> <p>Integrated daylight sensor for daylight harvesting and/or lumen maintenance.</p> <p>Bluetooth radio provides wireless control of luminaire.</p> <p>Simple plug-in connection to NX Fixture Modules.</p> <p>Wireless Internet.</p>	<p>The Athena wireless node is a radio frequency (RF) device that enables simple, digital control of individual light fixtures in an Athena control system.</p> <p>The small size and compatibility with a wide variety of drivers allow for seamless integration with common commercial lighting fixtures from any manufacturer.</p> <p>Requires drivers with auxiliary power, consult factory for lead times</p>

			
<p>NLT-AIR-rIO: Daylight+Occ</p>	<p>NLT-AIR-ADCX: Daylight+(PIR Acoustic) Occ</p>	<p>NLT-WIRED-nIO: Daylight+Occ</p>	<p>NLT-WIRED-ADCX: Daylight+(PIR Acoustic) Occ</p>
<p>The rIO is a fixture embedded low voltage wireless nLight AIR device capable of individual fixture control and analog or digital dimming. This smart device results in the luminaire being “nLight AIR-enabled” — making it an addressable nLight AIR device. It uses a 900MHz radio to communicate with other nLight AIR devices, such as occupancy sensors, photocells, wall switches, powerpacks and other nLight AIR-enabled luminaires. This allows for advanced operation and design flexibility ranging from stand-alone rooms to building and campus-wide networks.</p>	<p>The nLight® AIR rES7 sensor is an in-fixture, low voltage, digital sensor providing embedded wireless lighting control, analog or digital dimming, occupancy detection and daylight harvesting capabilities.</p> <p>The rES7 is designed for mounting heights up to 20 ft in indoor luminaires. The rES7 sensor provides Passive Infrared (PIR) occupancy detection over a 15-20 ft (4.57 - 6.10 m) radial coverage pattern and photocell light level detection in one compact low profile design with optional Dual Technology, which adds Microphonics™ to PIR detection. The rES7 sensor is ideal for occupancy and daylighting control in suspended or recessed luminaires.</p>	<p>nLight digital nIO modules are low voltage control devices that enable digital control of LEDcode enabled eldoLED LED drivers. Through eldoLED's bi-directional 2-wire interface, these modules deliver natural, flicker-free high performance dimming while eliminating common issues related to 0-10 VDC alternatives. The modules also enable the eldoLED LED Drivers to be addressable, as well as capable of digitally communicating with other nLight controls such as occupancy sensors, photocells, and WallPods. This allows for advanced operation and design flexibility ranging from stand-alone rooms to building and campus-wide networks.</p>	<p>The nES7 is a small passive infrared occupancy sensor designed to be easily embedded into luminaires. This sensor provides excellent line of sight 360° PIR detection of small motion and walking motion. The nES7 is ideal for small rooms without obstructions or areas with primarily walking motion (e.g. corridors, library stacks). Additionally, an optional integrated photocell enables daylight harvesting control as well. Typically one or more nES7 sensors are paired with an nLight controller within an nLight enabled luminaire.</p> <p>For rooms like classrooms and private offices or any space with obstructions, the nES PDT 7 dual technology sensor is recommended.</p>