



INSTALLATION INSTRUCTIONS

C2-60 CORNERS

NOTE: All driver power supply for corners are in an adjacent (satellite) fixture and Quick-Connected to the corner.

- 1)** Overlay lens so that the lens covers the fixture opening. Mark along the exposed edge.

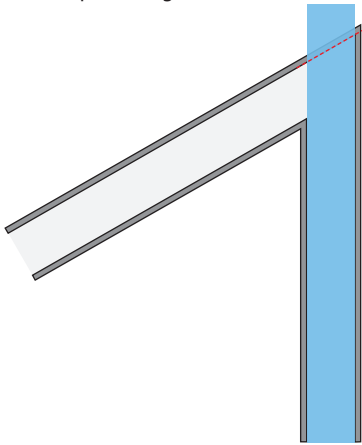

- 2)** Precut lens



- 3)** Reinstall the lens until it hits the first opposing side wall.

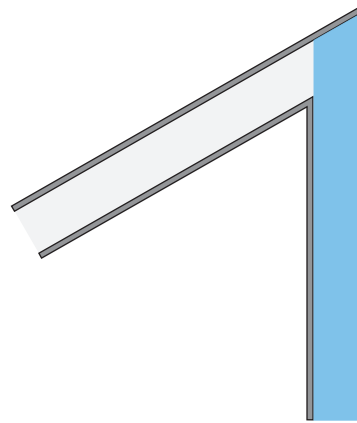

- 4)** Place the template aligning the corners of the fixture with template (red dots). Mark the cut line.

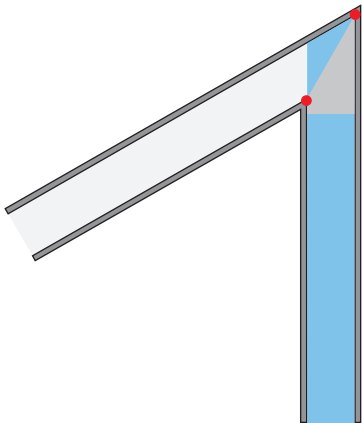

- 5)** Cut lens.



- 6)** Reinstall lens.

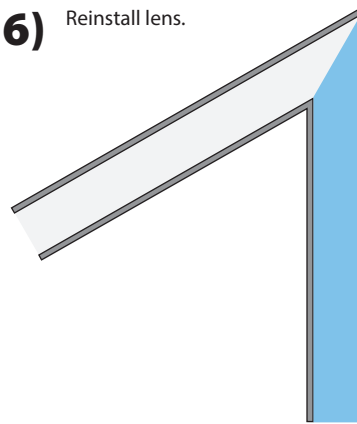

- 7)** Repeat for remaining leg, installing lens sleeve before the second lens.

WARNING: Ground fixture in accordance with local and national electrical codes. Failure to do so may result in serious personal injury.



INSTALLATION INSTRUCTIONS

C2-90, 120, 135 CORNERS

OPTION 1

SAL LENS ONLY

- 1)** Install lens until it hits the opposing wall.

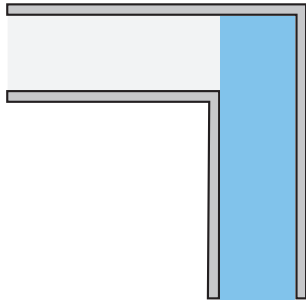

- 2)** Install second lens until it hits the opposing lens.

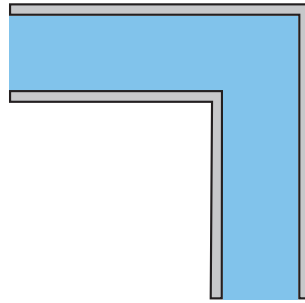

OPTION 2

- 1)** Install lens until it hits the opposing wall.

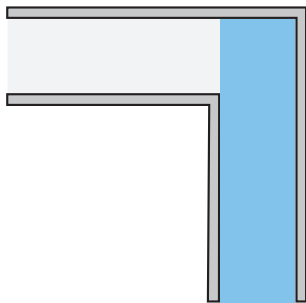

- 2)** Place the template aligning the corners of the fixture with the template (red dots). Mark cut line.

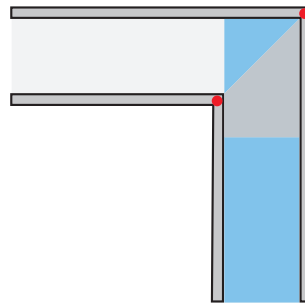

- 3)** Cut lens.



- 4)** Install lens. Repeat for remaining leg.

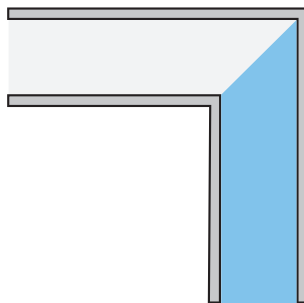

WARNING: Ground fixture in accordance with local and national electrical codes. Failure to do so may result in serious personal injury.



INSTALLATION INSTRUCTIONS

3-T, Y CORNERS

1) Install lens until it hits the opposing wall.

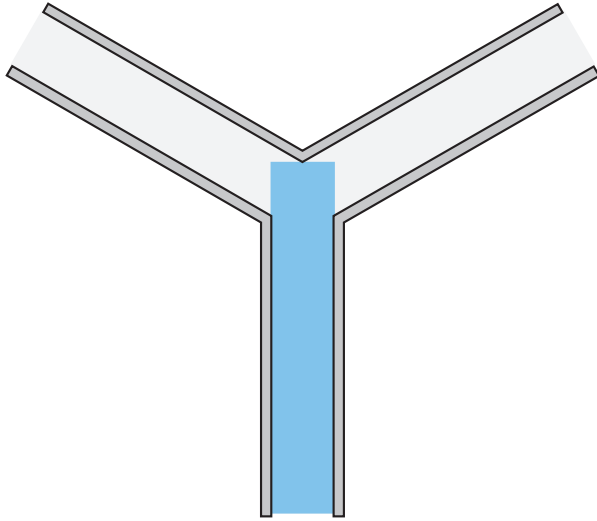

2) Place the template aligning the corners of the fixture with the template (red dots). Mark cut line.

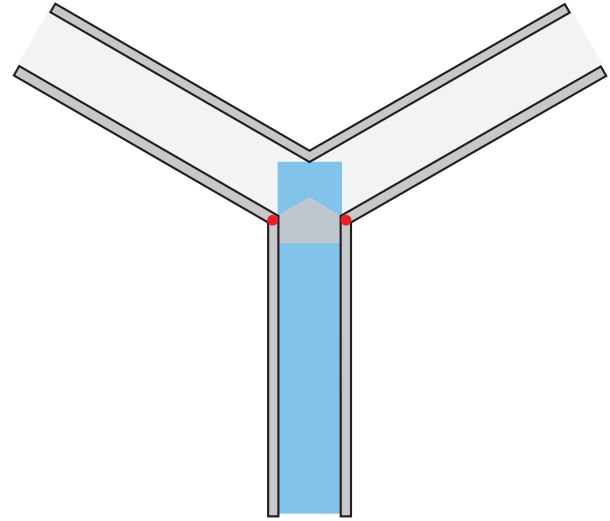

3) Cut lens.



2) Install lens. Repeat for remaining legs.

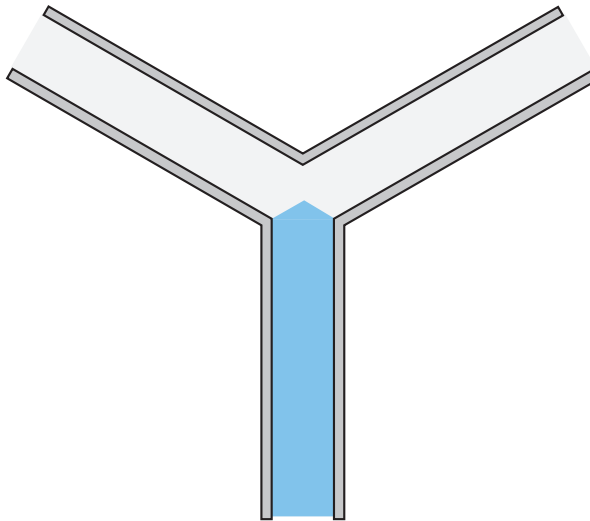

WARNING: Ground fixture in accordance with local and national electrical codes. Failure to do so may result in serious personal injury.



INSTALLATION INSTRUCTIONS

C4-T, X CORNERS

- 1)** Install lens through complete center of the fixture.

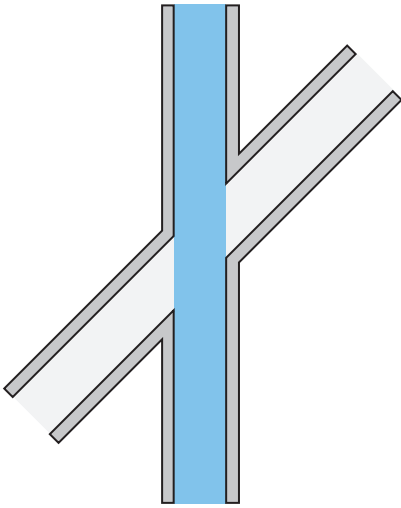

- 2)** Place the template aligning the corners of the fixture with the template (red dots). Mark the cut lens. Repeat for the second opposing lens intersection.

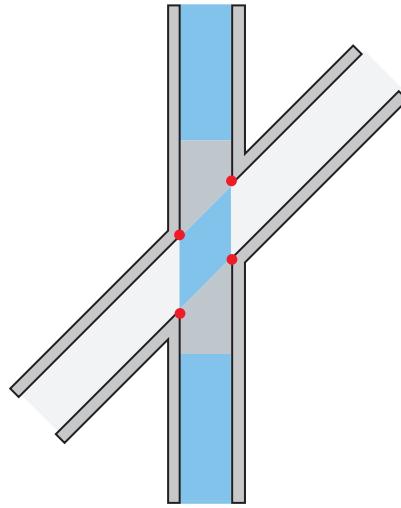

- 3)** Cut lens



- 4)** Install lens through complete center of the fixture.

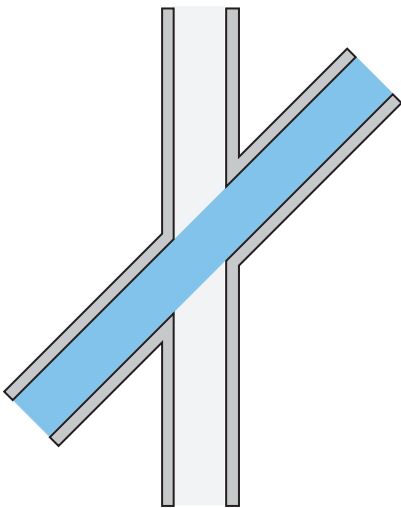

- 5)** Cut and install lens sleeve then cut lenses (step 2.)

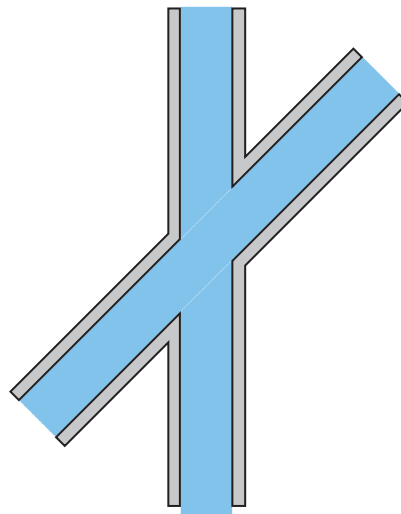

WARNING: Ground fixture in accordance with local and national electrical codes. Failure to do so may result in serious personal injury.