







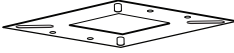

SDP + RDP

Top-Swivel Stem Mount

INSTALLATION INSTRUCTIONS

SSC-X3 + X1 OFF-GRID (XTP)

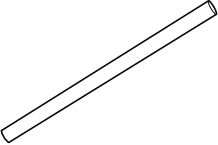

PARTS LIST	PART NO.	DESCRIPTION	QTY.
	109995	Square Dot Pendant — Alignment Plate (Square Dot Pendant ONLY)	1
	100-00050-14	8-32 x 7/8" TH MS Phil Screws	2
	100-00047-14	8-32 x 3/8" HHWSL Self Tap Screws	4
	100-00148-08	Mounting Strap	1
	100-00103-08	1/4" I.P.S. Ball Swivel	1
	100-00307-14	1/2" Ext Lock Washer	1
	100-00231-14	1/4" IPS HexLock Nut	2
	100-00032-14	M16 Plain Washer	1
	90934	24" —	1
	90937	48" —	
	90940	96" —	
	—	Custom —	

CANOPIES:

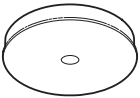
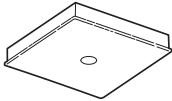
	109991	Round Dot Pendant Canopy	1
	109993	Square Dot Pendant Canopy	1

WARNING: Ground fixture in accordance with local and national electrical codes. Failure to do so may result in serious personal injury. Fixture Installations should ONLY be done by a qualified licensed electrical professional.

SDP + RDP

Top-Swivel Stem Mount

INSTALLATION INSTRUCTIONS

SSC-X3 + X1 OFF-GRID (XTP)



PRUDENTIAL LTG.

PRULITE.COM 213.746.0360

FIXTURE ASSEMBLY:

1. Attach mounting strap to electrical box. For square fixture use alignment plate (included). For round fixture fasten mounting strap directly to electrical box using (2x) 8-32 x 7/8" TH MS Phil screws.
2. Screw 1/4" I.P.S. ball swivel to one end of the threaded I.P.S. stem. Secure in place with set screw. Insert other end of stem through canopy hole and fasten to access plate with 1/4" IPS lock nuts and washer (provided).
3. Run electrical wires through stem and raise fixture to assembly to ceiling. Insert ball swivel into mounting strap. (**NOTE:** electrical wires provided by others).
4. Make all necessary wiring connections. Hand press canopy onto mounting strap.

NOTE: Mounting strap will accommodate a 3" & 4" octagonal box, or a 4" square box with plaster ring.

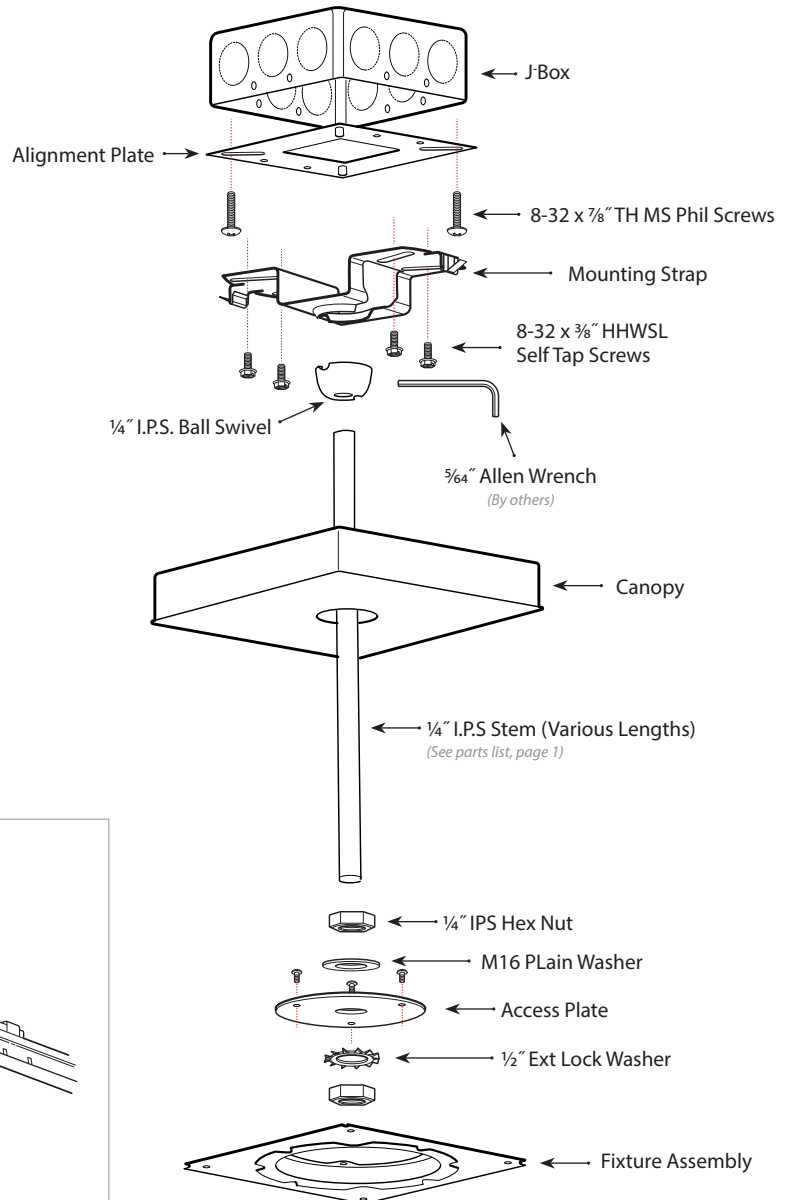

STC-XTP MOUNT:

- Mount using t-bar box hanger bracket (by others).
- Follow same installation steps as above.

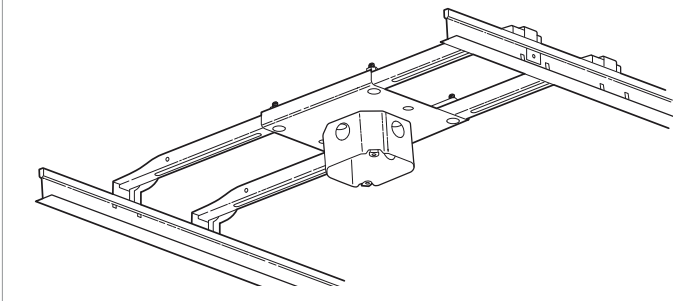

WARNING: Ground fixture in accordance with local and national electrical codes. Failure to do so may result in serious personal injury. Fixture installations should ONLY be done by a qualified licensed electrical professional.