



SDP + RDP | SSC EXCP







Top-Swivel Stem Mount

INSTALLATION INSTRUCTIONS

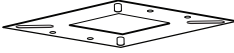

PRUDENTIAL LTG.

PRULITE.COM 213.746.0360

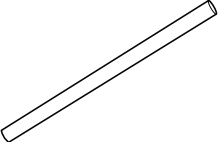
PARTS LIST	PART NO.	DESCRIPTION	QTY.
	109995	Square Dot Pendant — Alignment Plate (Square Dot Pendant ONLY)	1
	100-00050-14	8-32 x 7/8" TH MS Phil Screws	2
	100-00047-14	8-32 x 3/8" HHWSL Self Tap Screws	4
	100-00148-08	Mounting Strap	1
	100-00103-08	1/4" I.P.S. Ball Swivel	1
	100-00307-14	Lock Washer	1
	100-00231-14	1/4" Lock Nut	3
	90934	24" —	1
	90937	48" —	
	90940	96" —	
	—	Custom —	

CANOPIES:

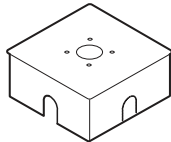

109996 **Square** Dot Pendant Canopy 1

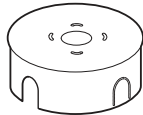

109997 **Round** Dot Pendant Canopy 1

WARNING: Ground fixture in accordance with local and national electrical codes. Failure to do so may result in serious personal injury.



FIXTURE ASSEMBLY:

1. Attach mounting strap to electrical box.
For square fixture use alignment plate (included). For round fixture fasten mounting strap directly to electrical box using (2x) 8-32 x 7/8" TH MS Phil screws.
2. Screw 1/4" I.P.S. ball swivel to one end of the threaded I.P.S. stem. Secure in place with set screw. Insert other end of stem through canopy hole and fasten to access plate with 1/4" lock nuts and washer (provided).
3. Run electrical wires through stem and raise fixture to assembly to ceiling. Insert ball swivel into mounting strap.
4. Make all necessary wiring connections. Hand press canopy onto mounting strap.

NOTE: Mounting strap will accommodate a 3" & 4" octagonal box, or a 4" square box with plaster ring.

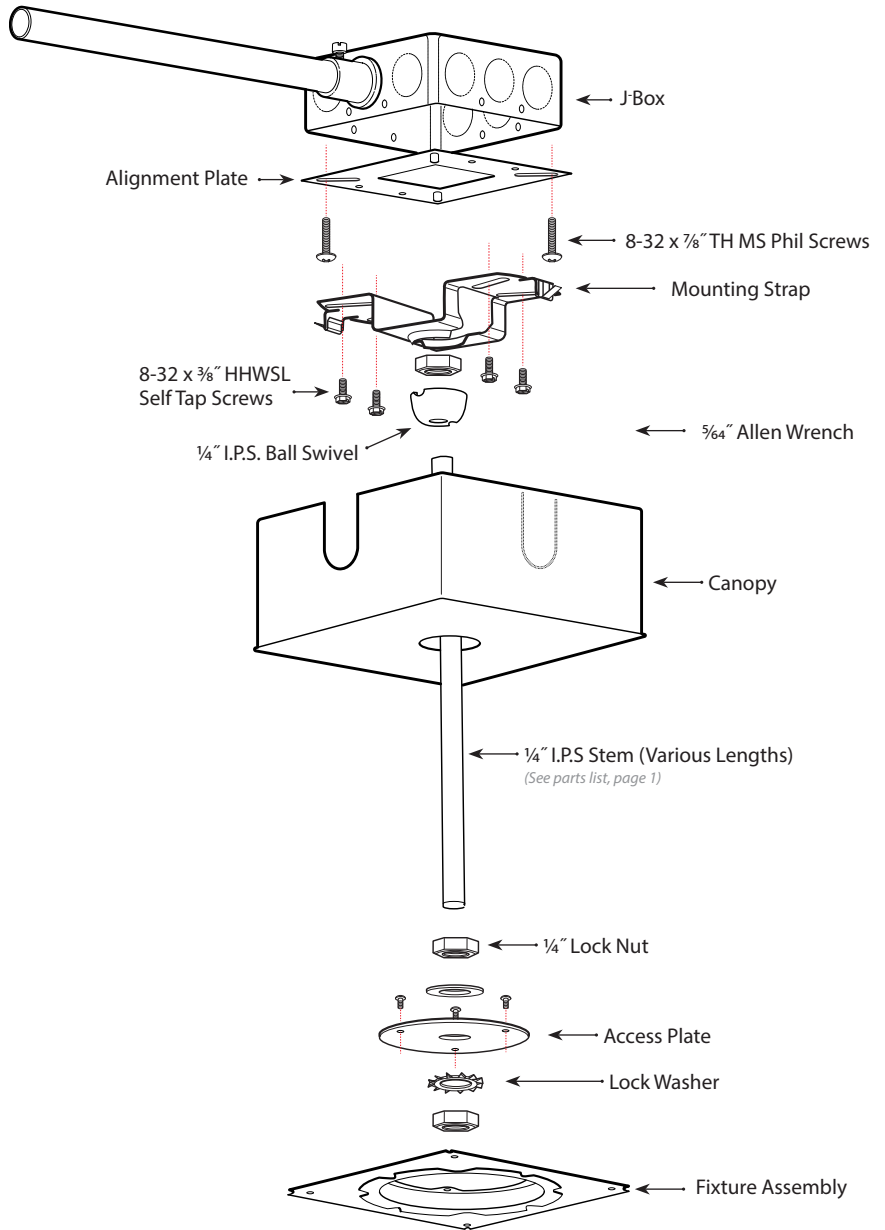

WARNING: Ground fixture in accordance with local and national electrical codes. Failure to do so may result in serious personal injury.