



Bolt Pentagon | Pendant, Surface & Wall



PRUDENTIAL LTG.

PRULITE.COM 213.746.0360



Type:

Job:

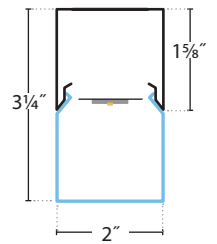

Working all the angles.

Forgettable, this new shape is not. Bolt is offered in Triangle, Square, Pentagon and Hexagon configurations commanding attention wherever it goes. It inspires, giving architects and lighting designers new fodder for thought.

BPEN-LED35-LO
5094 Delivered Lumens
41 Watts
125 lm/w

UP TO **125** LM/W

	LO	MO	SO	HO
lm	5000	6800	8000	9800
w	41	56	70	87

(CLICK HERE)



Lumen output may vary +/- 5%
3500K used for lm/ft estimates above
4000K +2% llf, 3000K -2%, 2700K -4%
-10% LLF for 90 CRI (4K, 3500K and 3K)

See LED Details PDF for more info

SERIES	NOMINAL LENGTH	LED COLOR	OUTPUT	SHIELDING	COLOR/ FINISH	VOLTAGE	MOUNTING	CEILING SYSTEMS	DRIVERS	OPTIONS & SENSORS
BPEN										
Bolt Pentagon	22 2' x 2' x 2' x 2' x 2' (41" Diameter)	LED27 2700K (90CRI) LED3 3000K LED35 3500K LED4 4000K LED3-90 90CRI LED35-90 90CRI LED4-90 90CRI	LO Low MO Medium SO Standard HO High PROG Pro-gramma-ble Light Output (Specify desired lm/ft or w/ft)	SAL Satin Acrylic Lens	TMW Textured Matte White YGW Gloss White (Standard) Y__ Premium Color CC Custom Color NOTE: All canopies are painted the same color as the fixture. Consult factory to specify	UNV (120-277) 347 (Emergency battery requires a Step Down transformer)	CA48", 96" or 144" Aircraft Cable (Adjustable) 5RPM48", 96" or 144" Round Cast Aluminum Canopy 5SPM48", 96" or 144" Square Cast Aluminum Canopy SUR Surface or Wall Mount (Hard ceiling only)	X1 T-Bar 1 5/16" or 9/16" Exposed (Standard) X3 Hard Ceiling X6 Slot Grid or Interlude	ND Non-Dimming DM01 0-10v, 1% Dimming (Standard) DM10 0-10v, 10% Dimming LDE5 5-Series EcoSystem LED LDE1 Hi-lume 1% EcoSystem LED (Soft fade on, fade-to-black dimming) LTE Hi-lume 1% 2-Wire LED Driver (120V forward phase only) ECO 1% 0-10v, EldoLED (Logarithmic dimming std) ECDA 1% DALI, EldoLED (Logarithmic dimming std) SOLO 0.1% 0-10v, EldoLED (Dim-to-dark, Logarithmic dimming std) SODA 0.1% DALI, EldoLED (Dim-to-dark, Logarithmic dimming std)	EML* Emergency Battery, Low (850 delivered lumens) EMH* Emergency Battery, High (1175 delivered lumens) *Remote only PRUBIN Meticulous Binning and Labeling every LED Board within a 2-Step MacAdams Ellipse SENSORS: 205 WattStopper PIR Occupancy 205-ND: On/off 205-DM: Dim to 10% / 1% 205-STEP: Dim to 50% ENL Enlighted 2-Wire DLH & Environmental



Prudential Ltg. reserves the right to change design specifications or materials without notice. Please visit prulite.com for most current data.
© 2014 All rights reserved - All products manufactured at: Prudential Ltg. 1774 E. 21st Street, Los Angeles, CA 90058

Pendant

1

10-09-2019



PHOTOMETRICS

Low Output:
BPEN-LED35-LO
 5094 Delivered Lumens
 41 Watts
 125 lm/w
 3500 CCT
 Test
 #103624486LAX-007

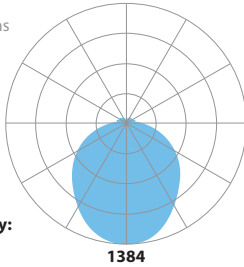

Zonal Lumen Summary:
 0-90 (Down) = 89%
 90-180 (Up) = 11%

Vertical Angle	0°	25°	45°	65°	90°
0°	1384	1384	1384	1384	1384
5°	1373	1374	1377	1381	1380
15°	1323	1321	1319	1322	1323
25°	1212	1210	1203	1210	1222
35°	1068	1056	1058	1072	1068
45°	916	904	906	920	920
55°	766	754	758	774	774
65°	605	595	599	617	617
75°	437	427	432	451	449
85°	276	265	270	288	283
90°	148	134	136	154	147
95°	154	144	144	158	148
105°	115	111	118	137	135
115°	100	97	98	105	103
125°	82	79	74	81	75
135°	66	65	62	64	60
145°	64	56	54	59	51
155°	44	40	40	40	37
165°	26	24	25	24	23
175°	11	11	10	11	10

LUMEN MAINTENANCE

Designed to last with cool running mid-power LEDs projected to maintain 90% (L90) of their initial output for 100,000 hours (at HO), and L70 exceeding 150,000 hours.

LED SYSTEM LED modules and drivers are field replaceable.

PROG (OPTIONAL) Programmable light output. Specify desired lumens or watts per fixture.

BINNING Standard binning (all Prudential LED boards) includes testing at the chip level and board integration to provide consistent color temperature within a 3-step MacAdams ellipse, with +/- 5% lumen output range and +/- .004 Duv.

PRUBIN™ (OPTIONAL) Prudential Ltg's exclusive 'job binning' method that ensures color temperature consistency across all luminaires on a project. Meticulously testing and labeling **EVERY LED BOARD** to +/- 25 lumens, +/- 50k CCT and +/- .004 Duv — while also separating positive from negative — allows us to match color, hue and intensity throughout a project and provides a consistent color temperature within a 2-step MacAdams ellipse.

LABELS ETL damp labeled and I.B.E.W. manufactured.

ELECTRICAL Must specify LED dimming controls. LED fixtures have constant current driver(s) with less than 20% THD when loaded to a minimum of 60%. Drivers sink a maximum of 6mA per driver. DM10 LED drivers are 0-10V dimmable and are compatible with most 0-10V wall slide dimmers and direct 0-10V analog signal dimmers. Max driver size 1¼" w x 1" h.

CONSTRUCTION

Housing Extruded aluminum, 25% PC recycled, 100% recyclable

Lens Extruded acrylic, 100% recyclable

MOUNTING Fixture is to be suspended with aircraft cables or surface mounted.

WEIGHT 20 lbs

WARRANTY Single-source, 5 year limited warranty covers standard components and construction.





YSW – Seashell White (Matte)	YCH – Champagne (Metallic)
YSL – Silver (Metallic)	YPE – Pewter (Matte)
YRG – Rain Grey (Gloss)	YSTM – Storm Grey (Matte)
YBK – Black (Matte)	YBB – Black (Semi Gloss)
YSKM – Sky (Matte)	YMB – Military Blue (Matte)
YIB – Interstate Blue (Matte)	YSAM – Sapphire (Matte)
YFGM – Forest Green (Matte)	YBR – Bronze (Matte)
YBY – Boysenberry (Matte)	YSRM – Sunset Red (Matte)
YOR – Orange (Matte)	YDAM – Daffodil (Matte)



SENSOR BOX



205
WattStopper PIR Occupancy



ENL
Enlighted 2-Wire PIR Daylight,
Motion & Environmental Sensor

SENSOR MOUNTING LOCATION

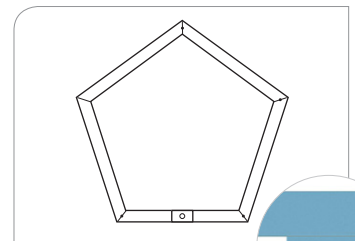

Sensor box is always centered in one lens

Choose from one of our Premium Colors with no set-up fee.

For paint chip samples, please email: info@prulite.com

Consult factory for other sensors.

NOTE: Sensor plate will match fixture color

MOUNTING

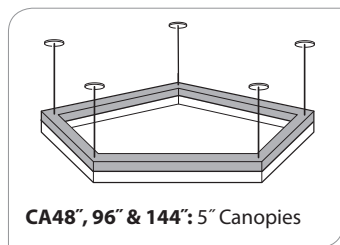

CA48\", 96\" & 144\": 5\" Canopies

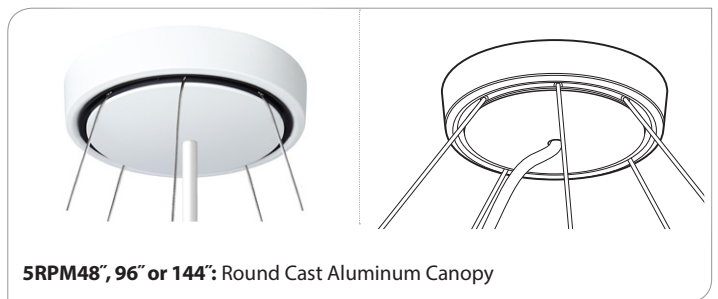

5RPM48\", 96\" or 144\": Round Cast Aluminum Canopy

MOUNTING DIMENSIONS

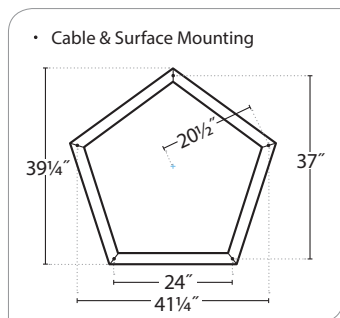

• Cable & Surface Mounting

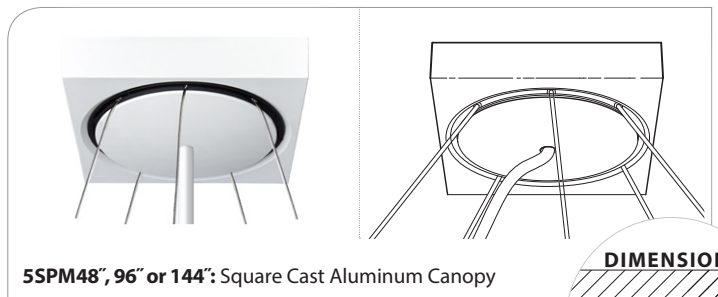

5SPM48\", 96\" or 144\": Square Cast Aluminum Canopy

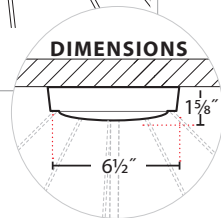

DIMENSIONS

