



Bolt Hexagon | Pendant, Surface & Wall



PRUDENTIAL LTG.

PRULITE.COM 213.746.0360

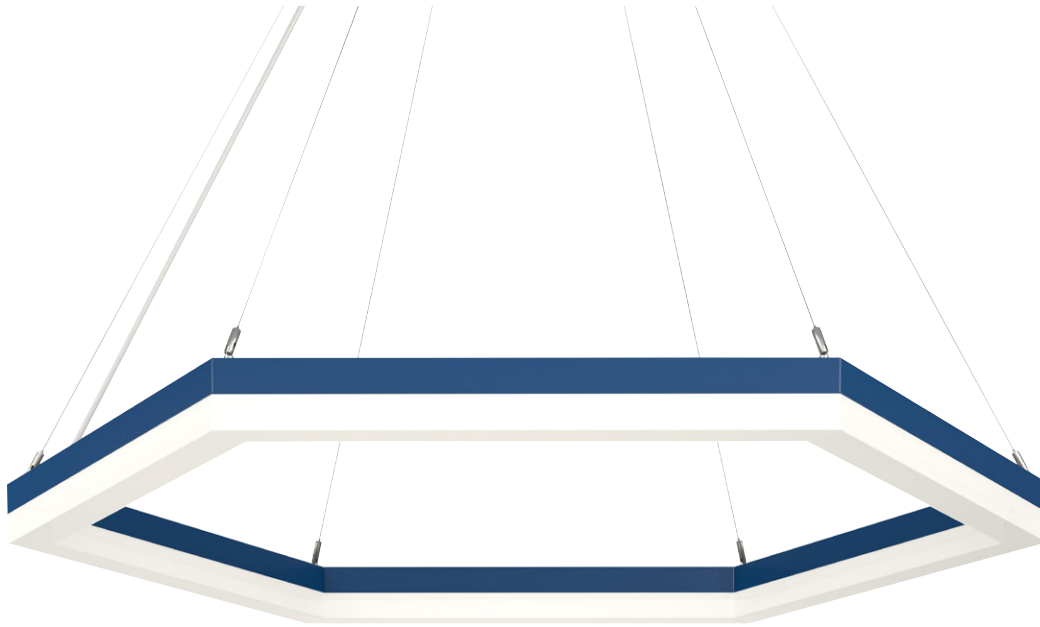

Type:

Job:

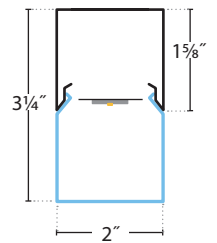

Working all the angles.

Forgettable, this new shape is not. Bolt is offered in Triangle, Square, Pentagon and Hexagon configurations commanding attention wherever it goes. It inspires, giving architects and lighting designers new fodder for thought.

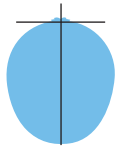

BHEX-LED35-LO
6172 Delivered Lumens
50 Watts
124 lm/w

UPTO **124** LM/W  **CLICK HERE**

	LO	MO	SO	HO
lm	6100	8300	9000	10750
w	50	67	84	105



Lumen output may vary +/- 5%
3500K used for lm/ft estimates above
4000K +2% llf, 3000K -2%, 2700K -4%
-10% LLF for 90 CRI (4K, 3500K and 3K)

See LED Details PDF for more info

SERIES	NOMINAL LENGTH	LED COLOR	OUTPUT	SHIELDING	COLOR/ FINISH	VOLTAGE	MOUNTING	CEILING SYSTEMS	DRIVERS	OPTIONS & SENSORS
BHEX										
Bolt Hexagon	22 2' x 2' x 2' x 2' 2' x 2' x 2' (50" Diameter)	LED27 2700K (90CRI) LED3 3000K LED35 3500K LED4 4000K LED3-90 90CRI LED35-90 90CRI LED4-90 90CRI	LO Low MO Medium SO Standard HO High PROG Pro-gram-mable Light Output (Specify desired lm/ft or w/ft)	SAL Satin Acrylic Lens	TMW Textured Matte White YGW Gloss White (Standard) Y__ Premium Color CC Custom Color NOTE: All canopies are painted the same color as the fixture. Consult factory to specify	UNV (120-277) 347 (Emergency battery requires a Step Down transformer)	CA48", 96" or 144" Aircraft Cable (Adjustable) 6RPM48", 96" or 144" Round Cast Aluminum Canopy 6SPM48", 96" or 144" Square Cast Aluminum Canopy SUR Surface or Wall Mount (Hard ceiling only)	X1 T-Bar 1 5/16" or 9/16" Exposed (Standard) X3 Hard Ceiling X6 Slot Grid or Interlude	ND Non-Dimming DM01 0-10v, 1% Dimming (Standard) DM10 0-10v, 10% Dimming LDE5 5-Series EcoSystem LED LDE1 Hi-lume 1% EcoSystem LED (Soft fade on, fade-to-black dimming) LTE Hi-lume 1% 2-Wire LED Driver (120V forward phase only) ECO 1% 0-10v, EldoLED (Logarithmic dimming std) ECDA 1% DALI, EldoLED (Logarithmic dimming std) SOLO 0.1% 0-10v, EldoLED (Dim-to-dark, Logarithmic dimming std) SODA 0.1% DALI, EldoLED (Dim-to-dark, Logarithmic dimming std)	EML* Emergency Battery, Low (850 delivered lumens) EMH* Emergency Battery, High (1175 delivered lumens) * Remote only PRUBIN Meticulous Binning and Labeling every LED Board within a 2-Step MacAdams Ellipse SENSORS: 205 WattStopper PIR Occupancy 205-ND: On/off 205-DM: Dim to 10% / 1% 205-STEP: Dim to 50% ENL Enlighted 2-Wire DLH & Environmental



Prudential Ltg. reserves the right to change design specifications or materials without notice. Please visit prulite.com for most current data.
© 2014 All rights reserved - All products manufactured at: Prudential Ltg. 1774 E. 21st Street, Los Angeles, CA 90058

Pendant

1

10-09-2019



PHOTOMETRICS

Low Output:

BHEX-LED35-LO

6172 Delivered Lumens

50 Watts

124 lm/w

3500 CCT

Test

#103624486LAX-008

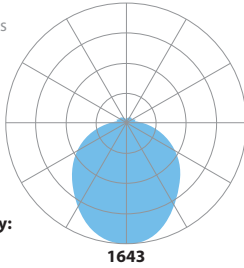

Zonal Lumen Summary:

0-90 (Down) = 88%

90-180 (Up) = 12%

Vertical Angle	0°	22.5°	45°	67.5°	90°
0°	1643	1643	1643	1643	1643
5°	1635	1635	1636	1639	1640
15°	1575	1580	1573	1575	1577
25°	1446	1449	1451	1454	1458
35°	1281	1285	1285	1282	1294
45°	1104	1112	1108	1101	1116
55°	922	933	928	918	935
65°	727	740	737	728	746
75°	523	534	532	529	545
85°	335	334	336	343	350
90°	159	163	166	170	186
95°	174	184	201	188	178
105°	155	159	153	148	159
115°	110	120	129	127	133
125°	82	96	98	100	106
135°	77	91	87	93	101
145°	66	70	70	77	77
155°	48	48	49	53	53
165°	27	26	28	30	30
175°	11	11	12	12	12

Luminance Chart:

Angle	0°	45°	90°
45°	44761	28824	25814
55°	44828	25393	22224
65°	45897	21975	18806
75°	49185	18051	15129
85°	65773	13709	11178

LUMEN MAINTENANCE

Designed to last with cool running mid-power LEDs projected to maintain 90% (L90) of their initial output for 100,000 hours (at HO), and L70 exceeding 150,000 hours.

LED SYSTEM LED modules and drivers are field replaceable.

PROG (OPTIONAL) Programmable light output. Specify desired lumens or watts per fixture.

BINNING Standard binning (all Prudential LED boards) includes testing at the chip level and board integration to provide consistent color temperature within a 3-step MacAdams ellipse, with +/- 5% lumen output range and +/- .004 Duv.

PRUBIN™ (OPTIONAL) Prudential Ltg's exclusive 'job binning' method that ensures color temperature consistency across all luminaires on a project. Meticulously testing and labeling **EVERY LED BOARD** to +/- 25 lumens, +/- 50k CCT and +/- .004 Duv — while also separating positive from negative — allows us to match color, hue and intensity throughout a project and provides a consistent color temperature within a 2-step MacAdams ellipse.

LABELS ETL damp labeled and I.B.E.W. manufactured.

ELECTRICAL Must specify LED dimming controls. LED fixtures have constant current driver(s) with less than 20% THD when loaded to a minimum of 60%. Drivers sink a maximum of 6mA per driver. DM10 LED drivers are 0-10V dimmable and are compatible with most 0-10V wall slide dimmers and direct 0-10V analog signal dimmers. Max driver size 1¼" w x 1" h.

CONSTRUCTION

Housing Extruded aluminum, 25% PC recycled, 100% recyclable

Lens Extruded acrylic, 100% recyclable

MOUNTING Fixture is to be suspended with aircraft cables or surface mounted.

WEIGHT 24 lbs

WARRANTY Single-source, 5 year limited warranty covers standard components and construction.





Bolt Hexagon | Pendant, Surface & Wall



PRUDENTIAL LTG.

PRULITE.COM 213.746.0360

YSW – Seashell White (Matte)	YCH – Champagne (Metallic)
YSL – Silver (Metallic)	YPE – Pewter (Matte)
YRG – Rain Grey (Gloss)	YSTM – Storm Grey (Matte)
YBK – Black (Matte)	YBB – Black (Semi Gloss)
YSKM – Sky (Matte)	YMB – Military Blue (Matte)
YIB – Interstate Blue (Matte)	YSAM – Sapphire (Matte)
YFGM – Forest Green (Matte)	YBR – Bronze (Matte)
YBY – Boysenberry (Matte)	YSRM – Sunset Red (Matte)
YOR – Orange (Matte)	YDAM – Daffodil (Matte)



Choose from one of our Premium Colors with no set-up fee.

For paint chip samples, please email: info@prulite.com

SENSOR BOX



205
WattStopper PIR Occupancy



ENL
Enlighted 2-Wire PIR Daylight, Motion & Environmental Sensor

Consult factory for other sensors

NOTE: Sensor plate will match fixture color

SENSOR MOUNTING LOCATION

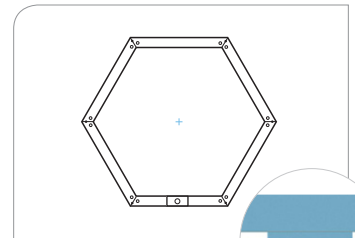

Sensor box is always centered in one lens

MOUNTING

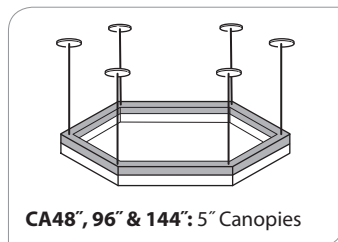

CA48, 96 & 144: 5" Canopies

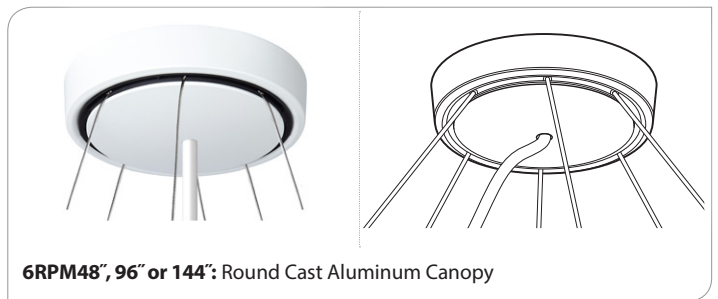

6RPM48, 96 or 144: Round Cast Aluminum Canopy

MOUNTING DIMENSIONS

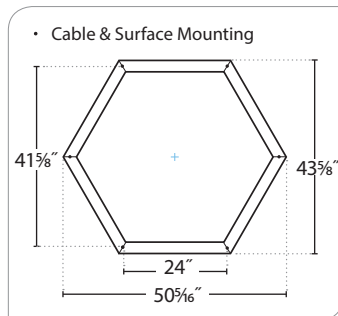

• Cable & Surface Mounting

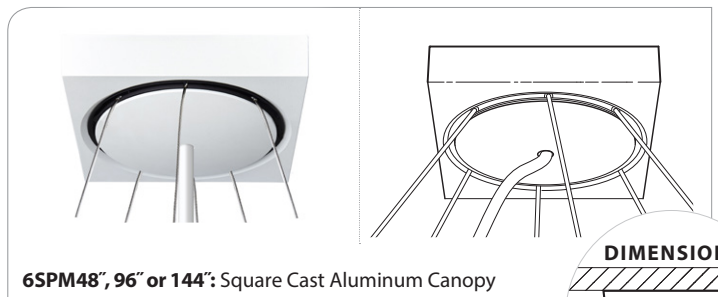

6SPM48, 96 or 144: Square Cast Aluminum Canopy

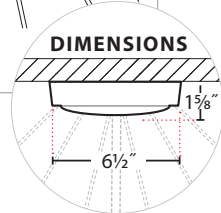

DIMENSIONS



Prudential Ltg. reserves the right to change design specifications or materials without notice. Please visit prulite.com for most current data. © 2014 All rights reserved – All products manufactured at: Prudential Ltg. 1774 E. 21st Street, Los Angeles, CA 90058