



Bio2 | Asymmetric Wall Wash

2" Linear



PRUDENTIAL LTG.

PRULITE.COM 213.746.0360

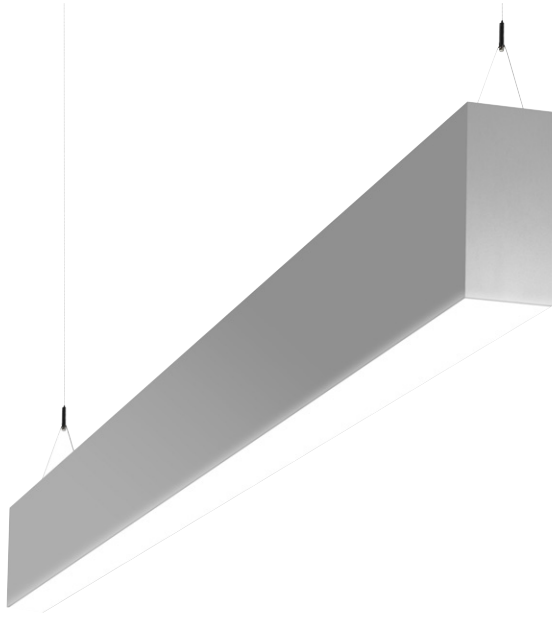

Type:

Job:

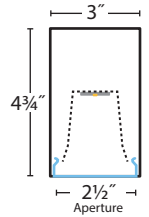

Open office illumination, wall washing or grazing.

Slimmer 2.5" aperture partner to our award-winning Bionic and P40 Series with the same industry-best combination of optics, efficacy and aesthetics. Wall washing and grazing with no mechanical kicker or open cavity.

Bio2 and P23 Series optics:

- Direct/Indirect:** Satin Acrylic, Batwing, Wash, Graze, Perimeter Fill, Ceiling Wash & Indirect Symmetric Glow
- Recessed Linear:** Satin Acrylic, Batwing, Wash and Graze
- Perimeter:** Satin Acrylic, Wash, Graze and Perimeter Fill

Low Output:
BIO2-LIN-LED4-LO-MWW-D1W
 1698 Delivered Lumens
 18.34 Watts
 92.58 lm/w

UP TO **93** LM/W

	LO	MO	SO	HO
D1W lm/ft	420	600	800	885
w/ft	4.5	7	10	12

[CLICK HERE](#)



Lumen output may vary +/- 5%
 4000K used for lm/ft estimates above
 3500K -2% Ifl, 3000K -4%, 2700K -6%
 -10% LLF for 90 CRI (4K, 3500K and 3K)

See LED Details PDF for more info

SERIES	LED COLOR	OUT-PUT	NOMINAL LENGTH	COLOR	SHIELD-ING	DISTRIBUTION	CIRCUIT-ING	VOLT-AGE	MOUNT-ING	CEILING SYSTEMS	DRIVERS	OPTIONS, SENSORS & CORNERS
BIO2-LIN						-						
Linear	LED27 2700K (90CRI) LED3 3000K LED35 3500K LED4 4000K LED3-90 90CRI LED35-90 90CRI LED4-90 90CRI	LO Low MO Me-dium SO Stan-dard HO High (NA for Lutron) NOTE: Specify separate output Down / Up if desired eg. HO/ LO PROG Pro-gram-mable Light Out-put (Specify desired lm/ft or w/ft)	2' 3' 4' 6' 8' R (Row length) NOTE: Individual fixtures are not intended for row mounting Row lengths are typically made up of 8" and 4" fixtures, (eg. 12' row is (1) 8" and (1) 4'), unless sym-metric row lengths are requested	TMW Tex-tured Matte White (Standard) YGW Gloss White Y_ Pre-mium Color CC Custom Color NOTE: All canopies are painted the same color as the fixture. Consult factory to specify.	MWW Acrylic Wall Wash Lens (D1W or D1R only) MWW-D1W	Choose Down -AND- Up DOWN: D1W Wall Wash (MWW only) UP: NU No Uplight CW Ceiling Wash SYM Sym-metric Lens SYMG Sym-metric with Glow Top Lens SY-MADC Sym-metric (with Acrylic Dust Cover) ACW Asym-metric Ceiling Wash	SC Single Circuit DC Dual Circuit (Two feeds re-quired)	UNV (120-277) 347 (Emer-gency battery re-quires a Step Down trans-former)	SUR Surface Mount (NU only) CA48", 96" or 144" Aircraft Cable (Adjust-able) WT Wall Tilt Bracket WS Wall Spacer (1/2" Stand-off) WB Wall Bracket SSC Stem Mount (Specify length, NU only)	X1 T-Bar 15/16" or 9/16" Exposed (Standard) Consult factory for 9/16" Tegular X3 Hard Ceiling X6 Slot Grid or Inter-lude	ND Non-Dimming DM10 0-10v, 10% Dimming (Standard) DM01 0-10v, 1% Dimming STEP Step Dimming, 100-50-Off, Osram NOTE: Lumens and watts per foot may differ for STEP drivers, consult factory LDE5* 5-Series EcoSystem LED LDE1* Hi-lume 1% EcoSystem LED (Soft fade on, fade-to-black dimming) LTE* Hi-lume 1%, 2-Wire LED Driver (120V forward phase only) * NA - HO ECO 1% 0-10v, EldoLED (Logarithmic dimming std) ECDA 1% DALI, EldoLED (Logarithmic dimming std) SOLO 0.1% 0-10v, EldoLED (Dim-to-dark, Logarithmic dimming std) SODA 0.1% DALI, EldoLED (Dim-to-dark, Logarithmic dimming std)	EML* Emergency Battery, Low (D1, D1W ~ 850 delivered lumens, D1G ~ 600) EMH* Emergency Battery, High (D1, D1W ~1175 delivered lumens, D1G ~ 900) *4" or longer (remote for < 4") PRUBIN Meticulous Binning and Labeling every LED Board within a 2-Step MacAdams Ellipse SENSORS: 205 ⁺ WattStopper PIR Occupancy 205-STEP: Dim to 50% 205-DM: Dim to 10% / 1% LUX ⁺ Phillips DLH ENL ⁺ Enlighted 2-Wire DLH & Environmental + Adds 3" to fixture length CORNERS: C2 90° 2-Way Lit C2X Special Angled Connector (Consult factory)



Prudential Ltg. reserves the right to change design specifications or materials without notice. Please visit prulite.com for most current data.
 © 2014 All rights reserved - All products manufactured at: Prudential Ltg. 1774 E. 21st Street, Los Angeles, CA 90058

Wall Wash

1

03-01-2018



Bio2 | Asymmetric Wall Wash

2" Linear



PRUDENTIAL LTG.

PRULITE.COM 213.746.0360

WALL WASH

Low Output:

BIO2-LIN-LED4-LO-MWW-D1W

1698 Delivered Lumens
18.34 Watts
92.58 lm/w
4000 CCT
Test
#102725395LAX-001

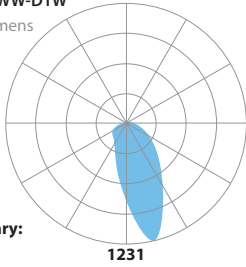

Zonal Lumen Summary: 0-90 = 100%

Vertical Angle	0°	22.5°	45°	67.5°	90°
0°	826	826	826	826	826
5°	1059	1040	975	900	828
15°	1184	1231	1219	1034	774
25°	832	869	1026	1080	674
35°	597	617	738	1024	536
45°	436	443	503	797	386
55°	307	312	332	538	248
65°	138	183	203	301	133
75°	48	63	104	127	50
85°	7	9	22	18	4
90°	0	0	0	0	0

Luminance Chart:

Angle	0°	45°	90°
45°	7951	9175	7038
55°	6916	7464	5583
65°	4226	6189	4064
75°	2380	5166	2499
85°	1045	3216	656

WALL WASH ORIENTATION

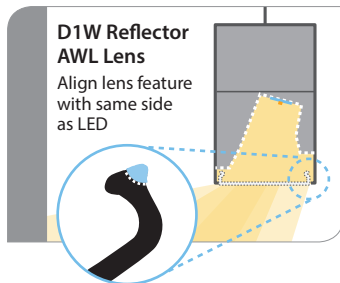

Wall Washing.

Our PruOptics™ reflector/refractor design delivers a high performance wall wash. No mechanical kickers needed.

30"



Standard Output - 750 lm/ft	10	9'	40fc	76/16	4.75
-----------------------------	----	----	------	-------	------

Watts/Ft.
Ceiling Height
Average Illuminance
Max/Min
Max/Min Ratio

Footcandles on Wall

Height	1'	2'	3'	4'	5'	6'	7'	8'	9'
1'	16	17	17	17	17	16	16	16	16
2'	22	23	24	23	22	22	22	22	22
3'	29	31	32	32	29	29	29	29	29
4'	39	43	44	43	39	39	39	39	39
5'	51	56	59	56	51	51	51	51	51
6'	62	68	72	68	62	62	62	62	62
7'	67	73	76	73	67	67	67	67	67
8'	55	60	62	60	55	55	55	55	55
9'	26	28	29	28	26	26	26	26	26

LUMEN MAINTENANCE

Designed to last with cool running mid-power LEDs projected to maintain 90% (L90) of their initial output for 100,000 hours (at HO), and L70 exceeding 150,000 hours.

LED SYSTEM

LED modules and drivers are field replaceable.

PROG

(OPTIONAL)

Programmable light output. Specify desired lumens or watts per linear foot. Min: 2.5 w/ft, consult factory for requests above 12 w/ft.

BINNING

Standard binning (all Prudential LED boards) includes testing at the chip level and board integration to provide consistent color temperature within a 3-step MacAdams ellipse. +/- 100 lumens, +/- 100k CCT and +/- .004 Duv.

PRUBIN™

(OPTIONAL)

Prudential Ltg's exclusive 'job binning' method that ensures color temperature consistency across all luminaires on a project. Meticulously testing and labeling **EVERY LED BOARD** to +/- 25 lumens, +/- 50k CCT and +/- .004 Duv — while also separating positive from negative — allows us to match color, hue and intensity throughout a project and provides a consistent color temperature within a 2-step MacAdams ellipse.

LABELS

ETL damp labeled and I.B.E.W. manufactured.

ELECTRICAL

Must specify LED dimming controls. LED fixtures have constant current driver(s) with less than 20% THD when loaded to a minimum of 60%. Drivers sink a maximum of 6mA per driver. DM10 LED drivers are 0-10V dimmable and are compatible with most 0-10V wall slide dimmers and direct 0-10V analog signal dimmers. Max driver size 1.625" w x 1.25" h.

CONSTRUCTION

Power cord is White except for fixtures painted Black (YBB, YBK) have Black power cords.

Housing

Extruded aluminum > 25% PC recycled, 100% recyclable.

Lens

Acrylic, 100% recyclable.

Weight

5 lbs / Ft.

MOUNTING

Surface mounted to walls or ceilings or suspended by cable or stem.

WARRANTY

Single-source, 5 year limited warranty covers standard components and construction.





Bio2 | Asymmetric Wall Wash

2" Linear



PRUDENTIAL LTG.

PRULITE.COM 213.746.0360

YSW – Seashell White (Matte)	YCH – Champagne (Metallic)
YSL – Silver (Metallic)	YPE – Pewter (Matte)
YRG – Rain Grey (Gloss)	YSTM – Storm Grey (Matte)
YBK – Black (Matte)	YBB – Black (Semi Gloss)
YSKM – Sky (Matte)	YMB – Military Blue (Matte)
YIB – Interstate Blue (Matte)	YSAM – Sapphire (Matte)
YFGM – Forest Green (Matte)	YBR – Bronze (Matte)
YBY – Boysenberry (Matte)	YSRM – Sunset Red (Matte)
YOR – Orange (Matte)	YDAM – Daffodil (Matte)



INTEGRATED SENSORS

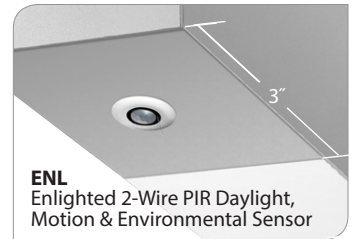
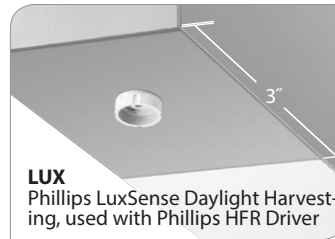

NOTE: Sensor plate will match fixture color finish

Consult factory for other sensors, please email: info@prulite.com

WALL MOUNTING

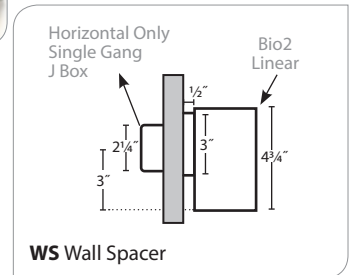
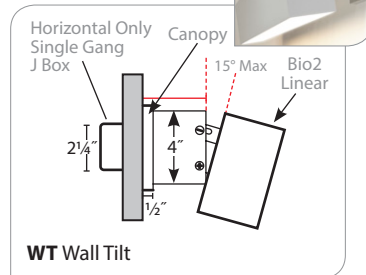
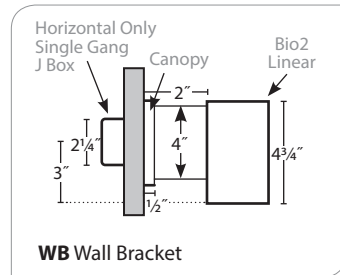

Choose from one of our Premium Colors with no set-up fee.

For paint chip samples, please email: info@prulite.com

CROSS SECTIONS

DOWN:

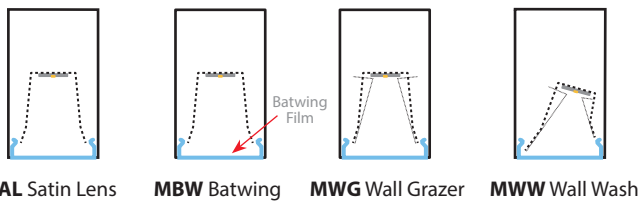

UP:

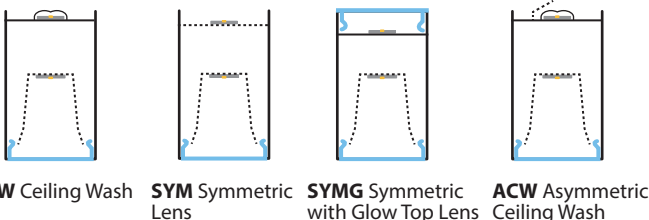

CORNERS

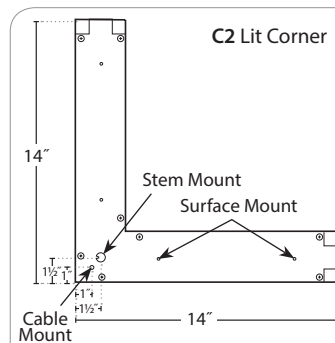

ADJOINING DETAIL

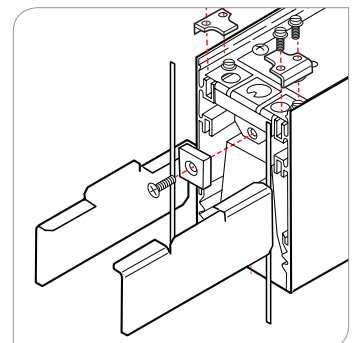

Prudential Ltg. reserves the right to change design specifications or materials without notice. Please visit prulite.com for most current data. © 2014 All rights reserved – All products manufactured at: Prudential Ltg. 1774 E. 21st Street, Los Angeles, CA 90058



Bio2 | Asymmetric Wall Wash

2" Linear



PRUDENTIAL LTG.

PRULITE.COM 213.746.0360

MOUNTING LOCATIONS

CABLE & STEM ROW:

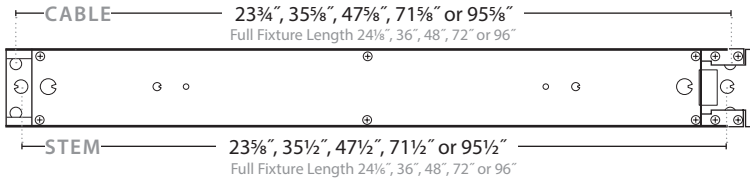

INDIVIDUAL CABLE & STEM:

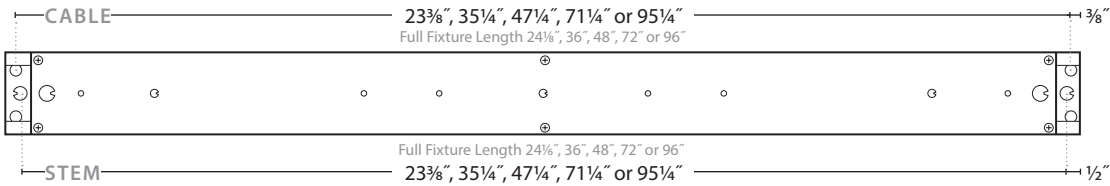

SURFACE MOUNTING:

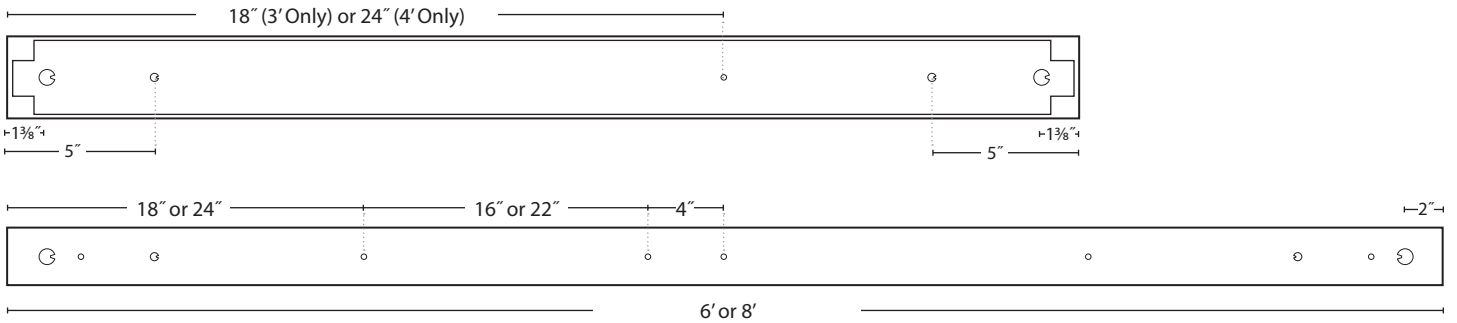

WALL MOUNTING SPACING:

2' WALL SIDE

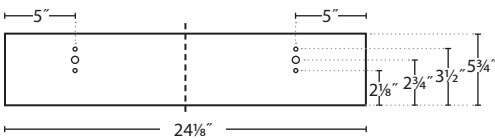

3' & 4' WALL SIDE

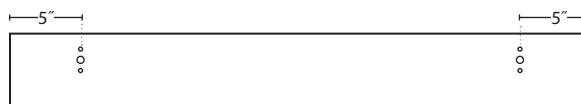

6' WALL SIDE

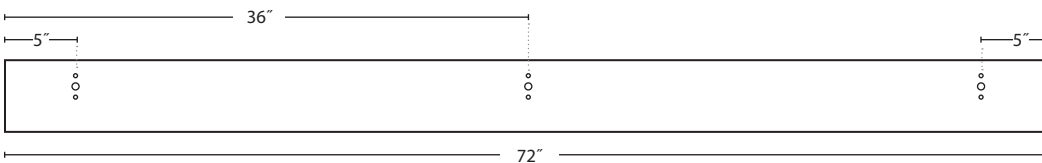

8' WALL SIDE

