



Bio2 | Linear, Surface & Wall

2" Linear



PRUDENTIAL LTG.

PRULITE.COM 213.746.0360

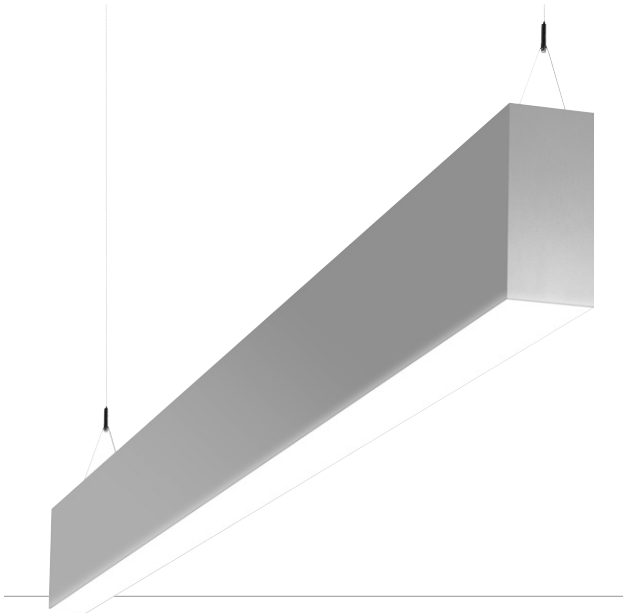

Open office illumination, wall washing or grazing.

Slimmer 2.5" aperture partner to our award-winning Bionic and P40 Series with the same industry-best combination of optics, efficacy and aesthetics. Batwing with 1.6 spacing criteria. Wall washing and grazing with no mechanical kicker or open cavity.

Bio2 and P23 Series optics:

- Direct/Indirect:** Satin Acrylic, Batwing, Wash, Graze, Perimeter Fill, Ceiling Wash & Indirect Symmetric Glow
- Recessed Linear:** Satin Acrylic, Batwing, Wash and Graze
- Perimeter:** Satin Acrylic, Wash, Graze and Perimeter Fill

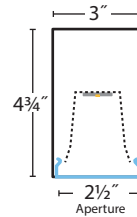

BIO2-LED35-HO/HO-SAL-D1-CW
8653 Delivered Lumens
90 Watts
97.3 lm/w

Type:

Job:

UP TO **97** LM/W



		LO	MO	SO	HO
UP & DOWN	CW with SAL-D1	lm/ft 935	1350	1850	1985
		w/ft 9	14	20	24
DOWN	MBW & SAL-D1	lm/ft 420	600	800	885
		w/ft 4.5	7	10	12
D1W/R		lm/ft 420	600	800	885
		w/ft 4.5	7	10	12
D1G		lm/ft 350	500	700	800
		w/ft 4.5	7	10	12
UP	CW	lm/ft 500	750	1000	1100
		w/ft 4.5	7	10	12
SYM		lm/ft 400	600	850	1000
		w/ft 4.5	7	10	12
ACW		lm/ft 375	550	700	875
		w/ft 4.5	7	10	12

Lumen output may vary +/- 5%
4000K used for lm/ft estimates above
3500K -2% llf, 3000K -4%, 2700K -6%
-10% LLF for 90 CRI (4K, 3500K and 3K)
See LED Details PDF for more info

SERIES	LED COLOR	OUTPUT	NOMINAL LENGTH	COLOR	SHIELDING	DISTRIBUTION	CIRCUITING	VOLTAGE	MOUNTING	CEILING SYSTEMS	DRIVERS	OPTIONS & CONTROLS
BIO2-LIN						-						
Linear	LED27 2700K (90CRI) LED3 3000K LED35 3500K LED4 4000K LED3-90 90CRI LED35-90 90CRI LED4-90 90CRI	LO Low MO Medium SO Standard HO High (NA for Lutron) NOTE: Specify separate output Down / Up if desired eg. HO/LO PROG Programmable Light Output (Specify desired lm/ft or w/ft)	2' 3' 4' 6' 8' R (Row length) NOTE: Individual fixtures are not intended for row mounting Row lengths are typically made up of 8' and 4' fixtures, (eg. 12' row is (1) 8' and (1) 4', unless symmetric row lengths are requested	TMW Textured Matte White (Standard) YGW Gloss White Y Premium Color CC Custom Color NOTE: All canopies are painted the same color as the fixture. Consult factory to specify.	SAL Satin Acrylic Lens (D1 only) MBW Batwing (D1 only) MWW Acrylic Wall Wash Lens (D1W or D1R only) MWG Acrylic Wall Graze Lens (D1G only)	Choose Down -AND- Up DOWN: NW No Downlight D1 Direct (SAL & MBW only) D1W Wall Wash (MWW only) D1R Perimeter Fill D1G Wall Graze (MWG only, WB recommended for wall mount) UP: NU No Uplight CW Ceiling Wash (Corners have SYM distribution) SYM Symmetric (No lens) SYMADC Symmetric (with Acrylic Dust Cover) SYMG Symmetric (with Glow Top Lens) ACW Asymmetric Ceiling Wash	SC Single Circuit DC Dual Circuit (Two feeds required) UNV (120-277) 347 (Emergency battery requires a Step Down transformer)	CA48", 96" or 144" Aircraft Cable (Adjustable) SUR Surface Mount (NU only) WT Wall Tilt Bracket WS Wall Spacer (1/2" Stand-off) WB Wall Bracket SSC Stem Mount (Specify length, NU only)	X1 T-Bar 1 1/16" or 1/4" Exposed (Standard) Consult factory for 1/2" Tegular X3 Hard Ceiling X6 Slot Grid or Interlude	ND Non-Dimming DM10 0-10v, 10% Dimming (Standard) DM01 0-10v, 1% Dimming STEP Step Dimming, 100-50-Off, Osram NOTE: Lumens and watts per foot may differ for STEP drivers, consult factory LDE5* 5-Series EcoSystem LED LDE1* Hi-Lume 1% EcoSystem LED (Soft fade on, fade-to-black dimming) LTE* Hi-Lume 1% 2-Wire LED Driver (120V forward phase only) * NA - HO ECO 1% 0-10v, EldoLED (Logarithmic dimming std) ECDA 1% DALI, EldoLED (Logarithmic dimming std) SOLO 0.1% 0-10v, EldoLED (Dim-to-dark, Logarithmic dimming std) SODA 0.1% DALI, EldoLED (Dim-to-dark, Logarithmic dimming std)	EML* Emergency Battery, Low (D1, D1W ~ 850 delivered lumens, D1G ~ 600) EMH* Emergency Battery, High (D1, D1W ~ 1175 delivered lumens, D1G ~ 900) PRUBIN Meticulous Binning and Labeling every LED Board within a 2-Step MacAdams Ellipse *4' or longer (remote for <4') CORNERS: C2 90° 2-Way Lit C2X Special Angled Connector (Consult factory) SENSORS: 205 WattStopper PIR Occupancy 205-STEP: Dim to 50% 205-DM: Dim to 10% / 1% LUX Phillips DLH ENL Enlighted 2-Wire DLH & Environmental	



Prudential Ltg. reserves the right to change design specifications or materials without notice. Please visit prulite.com for most current data.
© 2014 All rights reserved - All products manufactured at: Prudential Ltg. 1774 E. 21st Street, Los Angeles, CA 90058

Linear

1

08-05-2019



Bio2 | Linear, Surface & Wall

2" Linear



PRUDENTIAL LTG.

PRULITE.COM 213.746.0360

CEILING WASH/SATIN ACRYLIC

Low Output:

BIO2-LED35-HO/HO-SAL-D1-CW

8653 Delivered Lumens

90 Watts

97.3 lm/w

3500 CCT

Test #LM-63-2002

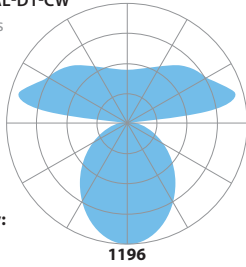

1196

Zonal Lumen Summary:

0-90 (Down) = 46.0%

90-180 (Up) = 54.0%

Vertical Angle	0°	22.5°	45°	67.5°	90°
0°	1890	1890	1890	1890	1890
5°	1883	1866	1868	1875	1871
15°	1706	1706	1727	1765	1762
25°	1405	1420	1483	1554	1576
35°	1065	1092	1179	1280	1215
45°	764	794	875	979	1016
55°	525	545	609	691	725
65°	331	343	383	435	459
75°	170	176	194	217	227
85°	48	48	53	55	57
90°	12	29	52	19	16
95°	193	394	395	67	35
105°	2018	1640	439	213	140
115°	1591	1295	595	363	263
125°	1494	1258	738	502	396
135°	1361	1176	820	614	527
145°	1155	1048	856	699	634
155°	1001	955	858	763	727
165°	922	892	851	817	799
175°	873	857	851	847	840
180°	854	854	854	854	854

Luminance Chart (SAL-D1):

Angle	0°	45°	90°
45°	4650	6340	15348
55°	3094	4380	13005
65°	1953	2820	10514
75°	1034	1507	7510
85°	311	449	3574

BATWING

Low Output:

BIO2-LIN-LED35-LO-MBW-D1

1703 Delivered Lumens

18 Watts

93 lm/w

3500 CCT

Test #11476049.01

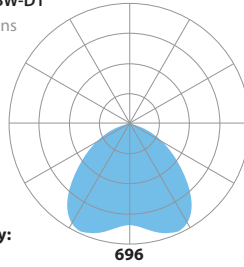

696

Zonal Lumen Summary:

0-90 (Down) = 100%

Vertical Angle	0°	22.5°	45°	67.5°	90°
0°	516	516	516	516	516
5°	543	535	535	514	508
15°	652	630	576	505	466
25°	696	675	608	482	401
35°	628	625	585	438	333
45°	477	492	497	369	271
55°	317	332	360	277	212
65°	178	188	208	171	143
75°	77	82	88	76	68
85°	14	16	16	14	13
90°	1	2	2	2	1

Luminance Chart:

Angle	0°	45°	90°
45°	8244	8590	4680
55°	6754	7669	4516
65°	5159	6016	4126
75°	3658	4166	3227
85°	1969	2252	1821

UPTO **93** LM/W

	LO	MO	SO	HO
lm/ft	420	600	800	885
w/ft	4.5	7	10	12

WALL WASH

Low Output:

BIO2-LIN-LED4-LO-MWW-D1W

1699 Delivered Lumens

18 Watts

94 lm/w

3500 CCT

Test #LM-63-2002

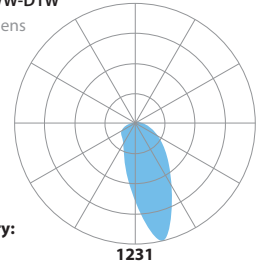

1231

Zonal Lumen Summary:

0-90 (Down) = 100%

Vertical Angle	0°	22.5°	45°	67.5°	90°
0°	826	826	826	826	826
5°	1059	1040	975	900	828
15°	1184	1231	1219	1034	774
25°	832	869	1026	1080	674
35°	597	617	738	1024	536
45°	436	443	503	797	386
55°	307	312	332	538	248
65°	138	183	203	301	133
75°	48	63	104	127	50
85°	7	9	22	18	4
90°	0	0	0	0	0

Luminance Chart:

Angle	0°	45°	90°
45°	7951	9175	7038
55°	6916	7464	5583
65°	4226	6189	4064
75°	2380	5166	2499
85°	1045	3216	656





Bio2 | Linear, Surface & Wall

2" Linear



PRUDENTIAL LTG.

PRULITE.COM 213.746.0360

WALL GRAZER

Low Output:

BIO2-LIN-LED35-LO-MWG-D1G

1391 Delivered Lumens
18 Watts
77 lm/w
4000 CCT
Test #LM-63-2002

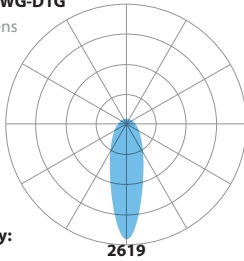

Zonal Lumen Summary: 0-90 (Down) = 100%

Vertical Angle	0	22.5	45	67.5	90
0	1278	1278	1278	1278	1278
5	1076	1095	1151	1235	1272
15	577	605	713	964	1236
25	341	362	450	680	1152
35	230	237	286	470	983
45	178	176	190	308	723
55	130	129	127	188	442
65	80	83	80	103	218
75	37	41	40	46	81
85	8	9	8	8	13
90	2	1	1	1	1

Luminance Chart:

Angle	0°	45°	90°
45°	2946	3150	11995
55°	2665	2600	9036
65°	2228	2222	6057
75°	1677	1794	3693
85°	1137	1073	1755

LUMEN MAINTENANCE

Designed to last with cool running mid-power LEDs projected to maintain 90% (L90) of their initial output for 100,000 hours (at HO), and L70 exceeding 150,000 hours.

LED SYSTEM

LED modules and drivers are field replaceable.

PROG

(OPTIONAL)

Programmable light output. Specify desired lumens or watts per linear foot. Min: 2.5 w/ft, consult factory for requests above 12 w/ft.

BINNING

Standard binning (all Prudential LED boards) includes testing at the chip level and board integration to provide consistent color temperature within a 3-step MacAdams ellipse. +/- 100 lumens, +/- 100k CCT and +/- .004 Duv.

PRUBIN™

(OPTIONAL)

Prudential Ltg's exclusive 'job binning' method that ensures color temperature consistency across all luminaires on a project. Meticulously testing and labeling **EVERY LED BOARD** to +/- 25 lumens, +/- 50k CCT and +/- .004 Duv — while also separating positive from negative — allows us to match color, hue and intensity throughout a project and provides a consistent color temperature within a 2-step MacAdams ellipse.

LABELS

ETL damp labeled and I.B.E.W. manufactured.

ELECTRICAL

Must specify LED dimming controls. LED fixtures have constant current driver(s) with less than 20% THD when loaded to a minimum of 60%. Drivers sink a maximum of 6mA per driver. DM10 LED drivers are 0-10V dimmable and are compatible with most 0-10V wall slide dimmers and direct 0-10V analog dimmers. Max driver size 1.625" w x 1.25" h.

CONSTRUCTION

Power cord is White except for fixtures painted Black (YBB, YBK) have Black power cords.

Housing

Extruded aluminum >25% PC recycled, 100% recyclable.

Lens

Acrylic, 100% recyclable.

Weight

5 lbs / Ft.

MOUNTING

Surface mounted to walls or ceilings or suspended by cable or stem.

WARRANTY

Single-source, 5 year limited warranty covers standard components and construction.





Bio2 | Linear, Surface & Wall

2" Linear



PRUDENTIAL LTG.

PRULITE.COM 213.746.0360

MOUNTING LOCATIONS

DIRECT ONLY:

CABLE:

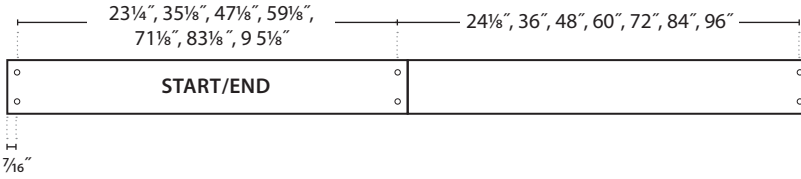

STEM:

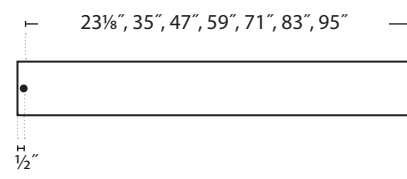

DIRECT / INDIRECT:

CABLE:

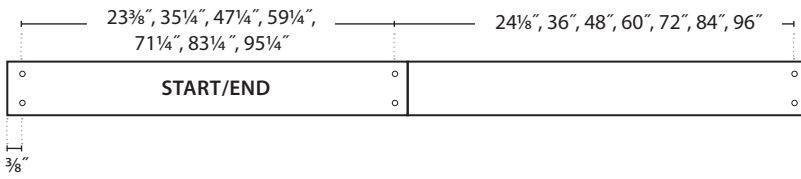

SURFACE MOUNTING:

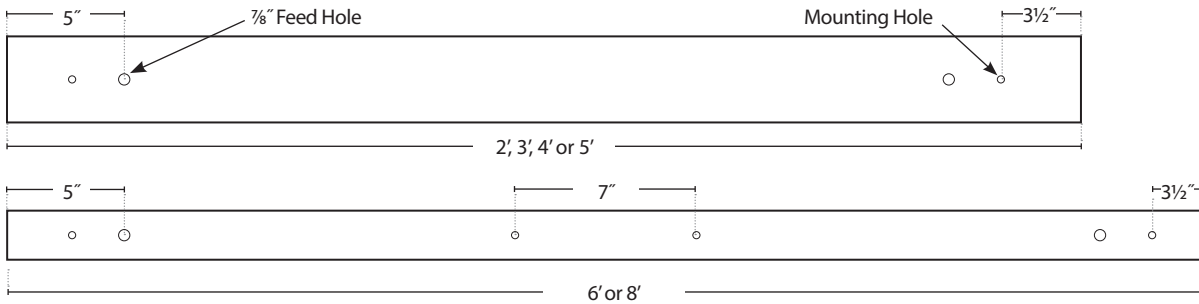

WALL MOUNTING SPACING:

2' WALL SIDE

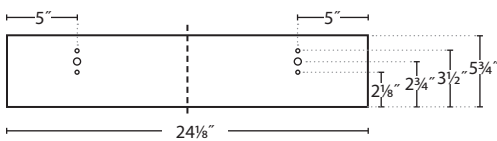

3' & 4' WALL SIDE

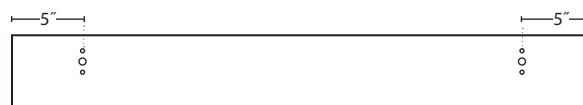

6' WALL SIDE

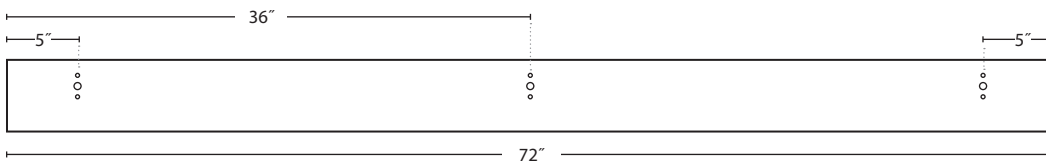

8' WALL SIDE

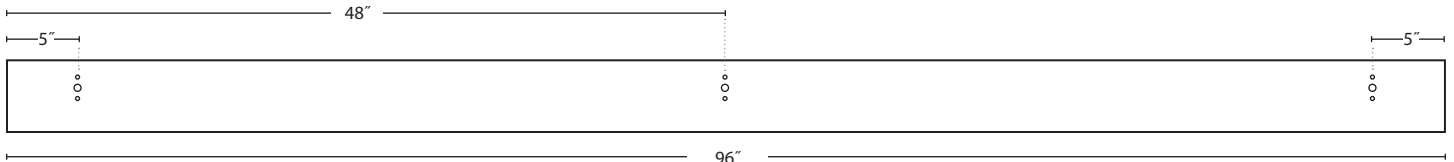

Prudential Ltg. reserves the right to change design specifications or materials without notice. Please visit prulite.com for most current data.
© 2014 All rights reserved - All products manufactured at: Prudential Ltg. 1774 E. 21st Street, Los Angeles, CA 90058

Linear

4

08-05-2019



Bio2 | Linear, Surface & Wall

2" Linear



PRUDENTIAL LTG.

PRULITE.COM 213.746.0360

YSW – Seashell White (Matte)	YCH – Champagne (Metallic)
YSL – Silver (Metallic)	YPE – Pewter (Matte)
YRG – Rain Grey (Gloss)	YSTM – Storm Grey (Matte)
YBK – Black (Matte)	YBB – Black (Semi Gloss)
YSKM – Sky (Matte)	YMB – Military Blue (Matte)
YIB – Interstate Blue (Matte)	YSAM – Sapphire (Matte)
YFGM – Forest Green (Matte)	YBR – Bronze (Matte)
YBY – Boysenberry (Matte)	YSRM – Sunset Red (Matte)
YOR – Orange (Matte)	YDAM – Daffodil (Matte)

Choose from one of our Premium Colors with no set-up fee.

For paint chip samples, please email: info@prulite.com

INTEGRATED SENSORS

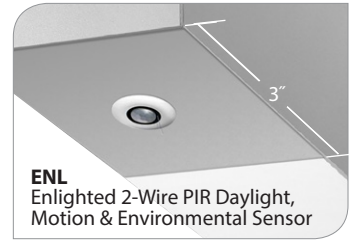
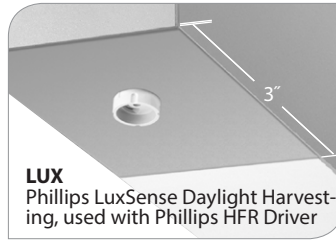

NOTE: Sensor plate will match fixture color finish

Consult factory for other sensors, please email: info@prulite.com

WALL MOUNTING

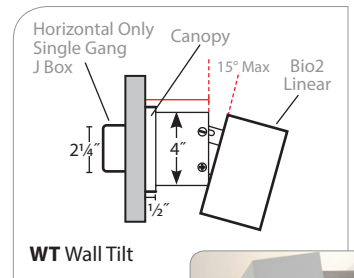
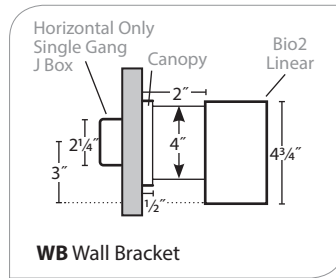
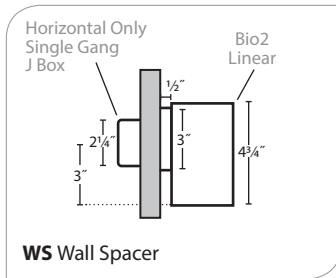

CORNERS

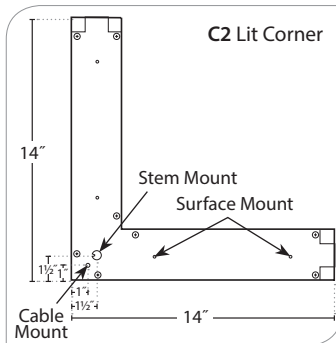

ADJOINING DETAIL

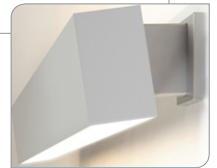
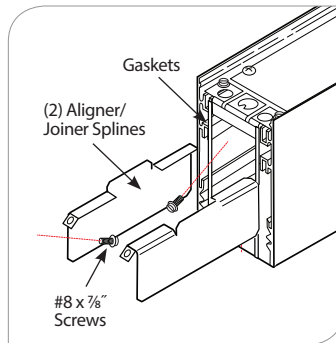

DISTRIBUTION — CROSS SECTIONS

DOWN:

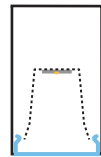

D1 Direct
(Shown with NU: No Uplight)

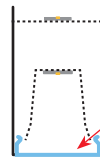

D1* Direct
(with MBW: Batwing Lens)

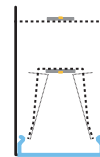

D1G* Wall Grazer

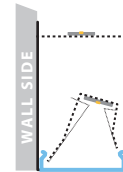

D1W* Wall Wash

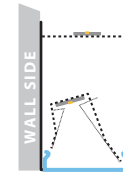

D1R* Perimeter Fill

* Shown with SYM: Symmetric Uplight

UP:

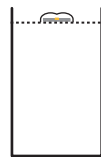

CW Ceiling Wash
(Shown with NW: No Downlight)

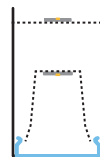

SYM* Symmetric

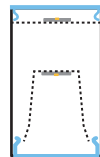

SYMG* Symmetric with Glow Top

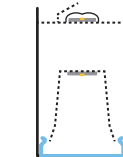

ACW* Asymmetric Ceiling Wash



ADC* Acrylic Dust Cover

* Shown with D1: Direct Downlight



Prudential Ltg. reserves the right to change design specifications or materials without notice. Please visit prulite.com for most current data.
© 2014 All rights reserved – All products manufactured at: Prudential Ltg. 1774 E. 21st Street, Los Angeles, CA 90058



The extreme low angle batwing of our ceiling wash optic creates beautifully uniform ceilings.

Batwing.

Batwing's wider distribution of light results in more even illumination over satin lensed symmetric glow. Spacing fixtures out at 12' or even 14' significantly reduces both

installation costs and long-term energy usage vs. 10' spacing. It's all about lowering watts per sq. ft and the Batwing is an excellent means of achieving that goal.

2" Batwing — 1.65 Spacing Criteria
2.1 MAX/MIN



Satin Lens Glow — 1.1 Spacing Criteria
3.8 MAX/MIN



9' ceilings
650 lm/ft at 6 w/ft
107 lm/w
35 fc average
.4 watts per sq. ft.

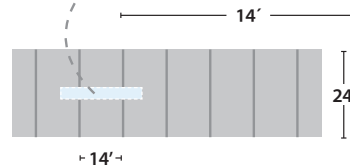

Wall Washing.

Our PruOptics™ reflector/refractor design delivers a high performance wall wash. No mechanical kickers needed.

30"

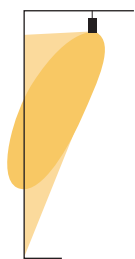

Watts/ Ft.
Ceiling Height
Average Illuminance
Max/Min
Max/Min Ratio

Standard Output - 750 lm/ft	10	9'	40fc	76/16	4.75
-----------------------------	----	----	------	-------	------

Footcandles on Wall

9'	26	28	29	28	26
8'	55	60	62	60	55
7'	67	73	76	73	67
6'	62	68	72	68	62
5'	51	56	59	56	51
4'	39	43	44	43	39
3'	29	31	32	32	29
2'	22	23	24	23	22
1'	16	17	17	17	16

WALL WASH ORIENTATION

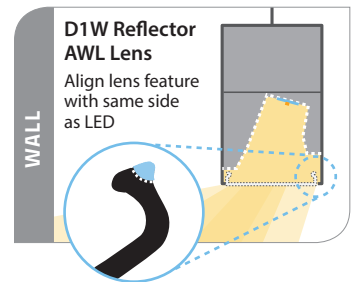



Bio2 | Linear, Surface & Wall

2" Linear



PRUDENTIAL LTG.

PRULITE.COM 213.746.0360

Smooth Wall Grazing.

A tight, focused beam grazes wall textures evenly, accenting and highlighting details to elevate the visual drama.

Watts/Ft Ceiling Height Average Illuminance Max Min Max/Min Ratio

Standard Output - 750 lm/ft	10	9'	40fc	76fc	16fc	4.75
-----------------------------	----	----	------	------	------	------



Perimeter Fill.

Fill a Corridor with Light — from the Perimeter.

It's a perimeter optic that washes corridors in light, offering outstanding light distribution, far more energy efficient than typical soft glow solutions and significantly reduces installation cost. Ideal for corridors where budget and energy efficiency conflict with strict IES requirements for high footcandles.

Suspended, surface mounted or recessed, perimeter lighting system.

Watts/Sq. Ft. Ceiling Height Average Illuminance Max/Min Max/Min Ratio

Standard Output - 875 lm/ft	1.25	9'	57fc	79/32	2.5:1
-----------------------------	------	----	------	-------	-------

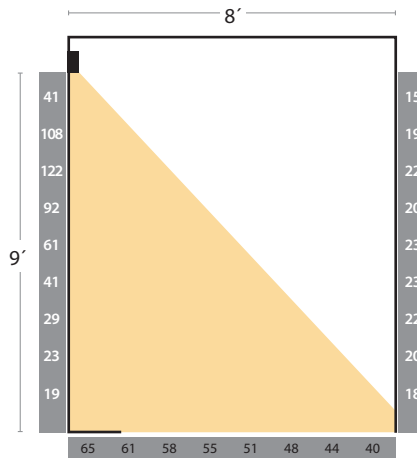

Footcandles along the floor Reflectances 80: 50: 20

PERIMETER FILL ORIENTATION

