



P8900 | Recessed



PRUDENTIAL LTG.

PRULITE.COM 213.746.0360



Type:

Job:

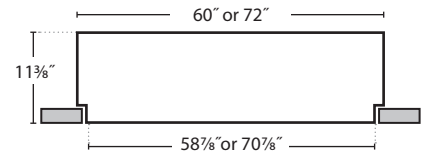
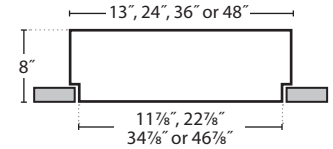

		LO	MO	SO	HO
12\"	lm	550	700	1100	1400
	w	14	18	28	35
2\"	lm	2100	3150	3900	5300
	w	35	54	67	97
3\"	lm	4500	7000	9000	13275
	w	56	87	113	177
4\"	lm	7000	8800	13900	21000
	w	88	110	174	281
5\"	lm	9600	15000	21500	29000
	w	120	200	270	400
6\"	lm	14000	21500	28000	35000
	w	180	270	370	500



Our ever-popular 'skylights'

The standard for four decades with a slightly regressed 2" trim for a skylight effect.

Perfect partner to our P3900 Sky Oculus pendant.

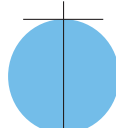

P8940-LED35-LO-FWA
7017 Delivered Lumens
88 Watts
80 lm/w



Lumen output may vary +/- 5% 3500K used for lm/ft estimates above 4000K +2% If, 3000K -2%, 2700K -4% -10% LLF for 90 CRI (4K, 3500K and 3K)

See LED Details PDF for more info

SERIES	LED COLOR	OUTPUT	SHIELDING	TRIM COLOR	CIRCUIT-ING	VOLTAGE	CEILING SYSTEMS	DRIVERS	OPTIONS
P8912 12" Dia.	LED27 2700K	LO Low	CWA Concave White Acrylic (NA - 12" & 2')	TMW Textured Matte White (Standard)	SC Single Circuit	UNV (120-277)	X1 T-Bar Exposed (Standard)	ND Non-Dimming	EML Emergency Battery, Low (P8912 & P8920: 400; P8930: 650; P8940, P8950 & P8960: 700 delivered lumens)
P8920 2" Dia.	LED3 3000K	MO Medium	VVA Convex White Acrylic	YGW Gloss White		347 (NA with EML/H)	X1T T-Bar Ceiling with Tegular Panels	DM10 0-10v, 10% Dimming (Standard)	EMH Emergency Battery, High (NA 12" & 2', P8930: 950; P8940, P8950 & P8960: 1000 delivered lumens)
P8930 3" Dia.	LED35 3500K	SO Standard	FWA Flat White Acrylic (NA - 6')	Y Premium Color			X3B Hard Ceiling (Flange Trim)	DM01 0-10v, 1% Dimming	CP Chicago Plenum
P8940 4" Dia.	LED4 4000K	HO High		CC Custom Color				STEP Step Dimming, 100-50-Off, Osram	PRUBIN Meticulous Binning and Labeling every LED Board within a 2-Step MacAdams Ellipse
P8950 5" Dia.	LED3-90 90CRI	PROG Programmable Light Output (Specify desired lumens or watts per fixture)						NOTE: Lumens and watts per foot may differ for STEP drivers, consult factory	
P8960 6" Dia.	LED35-90 90CRI LED4-90 90CRI							LDE5 5-Series EcoSystem LED	
								LDE1 Hi-lume 1% EcoSystem LED (Soft fade on, fade-to-black dimming)	
								LTE Hi-lume 1% 2-Wire LED Driver (120V forward phase only)	
								ECO 1% 0-10v, EldoLED	
								ECDA 1% DALI, EldoLED	
								SOLO 0.1% 0-10v, EldoLED (Dim to Dark)	
								SODA 0.1% DALI, EldoLED (Dim to Dark)	



Prudential Ltg. reserves the right to change design specifications or materials without notice. Please visit prulite.com for most current data. © 2014 All rights reserved - All products manufactured at: Prudential Ltg. 1774 E. 21st Street, Los Angeles, CA 90058

Sky Oculus Series

1

02-27-2019



P8900 | Recessed



PRUDENTIAL LTG.

PRULITE.COM 213.746.0360

PHOTOMETRICS

Low Output:
P8940-LED35-LO-FWA
 7017 Delivered Lumens
 88 Watts
 80 lm/w
 3500 CCT
 Test #L041411805

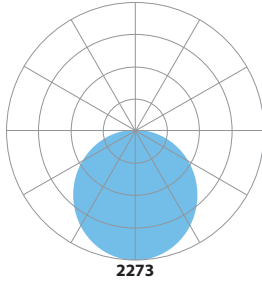

Zonal Lumen Summary:
 0-90 = 100%

Vertical Angle	0°	22.25°	45°	67.5°	90°
0°	2273	2273	2273	2273	2273
5°	2260	2260	2260	2260	2260
15°	212	212	212	212	212
25°	2005	2005	2005	2005	2005
35°	1773	1773	1773	1773	1773
45°	1484	1484	1484	1484	1484
55°	1150	1150	1150	1150	1150
65°	807	807	807	807	807
75°	440	440	440	440	440
85°	131	131	131	131	131
90°	0	0	0	0	0

Luminance Chart:

Angle	0°	45°	90°
45°	1959	1959	1959
55°	1871	1871	1871
65°	1782	1782	1782
75°	1587	1587	1587
85°	1403	1403	1403

LUMEN MAINTENANCE

Designed to last with cool running mid-power LEDs projected to maintain 90% (L90) of their initial output for 100,000 hours (at HO), and L70 exceeding 150,000 hours.

LED SYSTEM LED modules and drivers are field replaceable.

PROG (OPTIONAL) Programmable light output. Specify desired lumens or watts per fixture.

BINNING Standard binning (all Prudential LED boards) includes testing at the chip level and board integration to provide consistent color temperature within a 3-step MacAdams ellipse, with +/- 5% lumen output range and +/- .004 Duv.

PRUBIN™ (OPTIONAL) Prudential Ltg's exclusive 'job binning' method that ensures color temperature consistency across all luminaires on a project. Meticulously testing and labeling **EVERY LED BOARD** to +/- 25 lumens, +/- 50k CCT and +/- .004 Duv — while also separating positive from negative — allows us to match color, hue and intensity throughout a project and provides a consistent color temperature within a 2-step MacAdams ellipse.

LABELS ETL damp labeled and I.B.E.W. manufactured.

ELECTRICAL Must specify LED dimming controls. LED fixtures have constant current driver(s) with less than 20% THD when loaded to a minimum of 60%. Drivers sink a maximum of 6mA per driver. DM10 LED drivers are 0-10V dimmable and are compatible with most 0-10V wall slide dimmers and direct 0-10V analog signal dimmers. Max driver size 1.25" w x 1" h.

CONSTRUCTION

Housing Die-formed 20-gauge steel, >20% PC recycled, 100% recyclable.

Lens Acrylic, 100% recyclable.

MOUNTING Recessed mounted into T-bar or hard ceiling applications.

WARRANTY Single-source, 5 year limited warranty covers standard components and construction.





P8900 | Recessed



PRUDENTIAL LTG.

PRULITE.COM 213.746.0360

YSW – Seashell White (Matte)	YCH – Champagne (Metallic)
YSL – Silver (Metallic)	YPE – Pewter (Matte)
YRG – Rain Grey (Gloss)	YSTM – Storm Grey (Matte)
YBK – Black (Matte)	YBB – Black (Semi Gloss)
YSKM – Sky (Matte)	YMB – Military Blue (Matte)
YIB – Interstate Blue (Matte)	YSAM – Sapphire (Matte)
YFGM – Forest Green (Matte)	YBR – Bronze (Matte)
YBY – Boysenberry (Matte)	YSRM – Sunset Red (Matte)
YOR – Orange (Matte)	YDAM – Daffodil (Matte)



Client | Mercer Architect | GKK Works

MOUNTING LOCATIONS

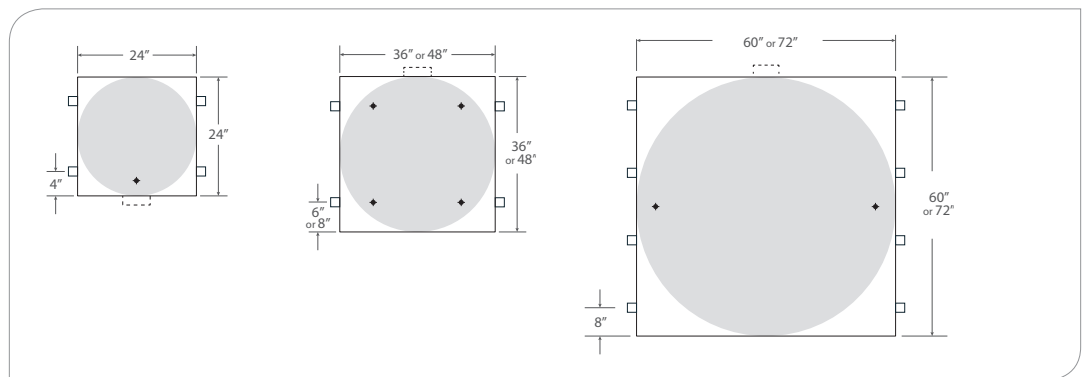

Choose from one of our Premium Colors with no set-up fee.

For paint chip samples, please email: info@prulite.com

CEILING SYSTEMS

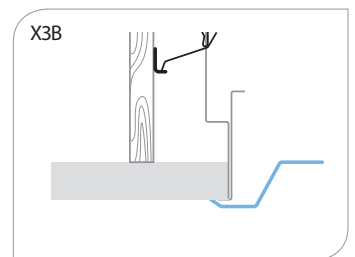
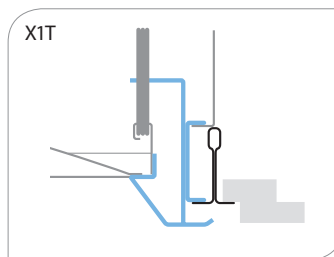
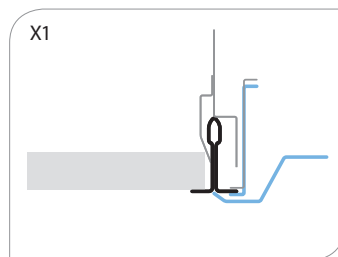

NOTE: Fixture must be installed

COMPLIMENTARY FIXTURES

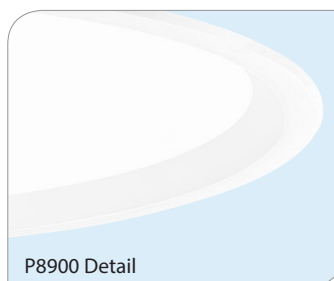
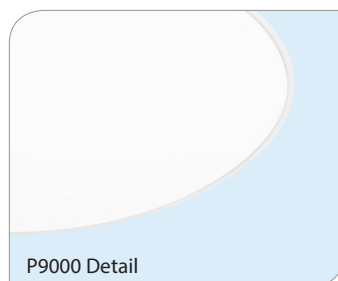

Prudential Ltg. reserves the right to change design specifications or materials without notice. Please visit prulite.com for most current data. © 2014 All rights reserved – All products manufactured at: Prudential Ltg. 1774 E. 21st Street, Los Angeles, CA 90058