



# P43 | Cove & Perimeter

## 4" Perimeter



PRUDENTIAL LTG.

PRULITE.COM 213.746.0360

**DISCONTINUED**

Click for **BionicPro**

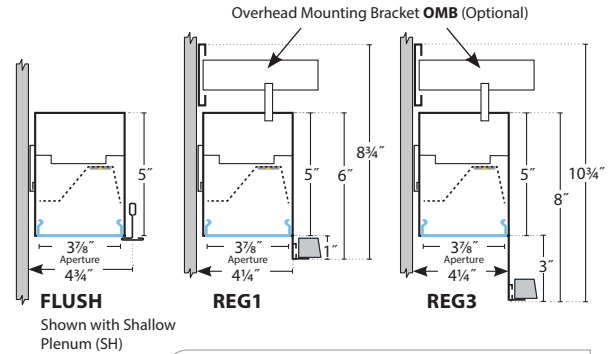

**High performance wall grazer.**

**Optics:** Glow, Wall Graze or Wash a corridor in light (D1R).

**Series:** P43 recessed linear and Wall Wash for visual continuity.

Bionic Perimeter System contains same great optics with extruded aluminum housing to accommodate more ceiling systems.

**LOW OUTPUT:**  
**P43-PSTD-FLSH-LED4-LO-AWW-D1G**  
 1620 Delivered Lumens  
 16 Watts  
 101 Lm/W  
 4000 CCT

UP TO **101** LPW

FLUSH:	LO	MO	SO	HO
<b>SAL-D1</b> Lm/Ft	400	600	800	900
<b>AWW-D1G</b> Lm/ft	400	600	800	900
<b>AWL-D1R</b> Lm/Ft	400	600	800	900
REGRESS 3:	LO	MO	SO	HO
<b>REG3-SAL</b> Lm/Ft	350	500	700	800
<b>REG3-D1G</b> Lm/Ft	350	500	700	800
<b>W/Ft</b>	4.6	6.5	9.5	11

[CLICK HERE](#)



Lumen output may vary +/- 5%  
 4000K used for lm/ft estimates above  
 3500K -2% If, 3000K -4%, 2700K -6%  
 -10% LLF for 90 CRI (4K, 3500K and 3K)

See LED Details PDF for more info

SERIES	LENS POSITION	LED COLOR	OUTPUT	NOMINAL LENGTH	TRIM COLOR	SHIELDING	DISTRIBUTION	MOUNTING	CIRCUITING	CEILING SYSTEMS	VOLTAGE	DRIVERS	OPTIONS, SENSORS & CORNERS
P43-PSTD									SC				
Perimeter Standard	FLSH Flush Lens REG1 1" Regress Lens REG3 3" Regress Lens	LED27 2700K (90CRI) LED3 3000K LED35 3500K LED4 4000K LED3-90 90CRI LED35-90 90CRI LED4-90 90CRI	LO Low MO Medium SO Standard HO High PROG Programmable Light Output (Specify desired lm/ft or w/ft)	2' 3' 4' 6' 7' 8' R (Row length) Any row length is achievable with field trimable filler kit NOTE: Individual not intended for row mounting	TMW Textured Matte White (Standard) YGW Gloss White Y Pre-mium Color CC Custom Color	SAL Satin Acrylic Lens (D1 only) AWW Acrylic Wall Grazer Lens (D1G only) AWL Perimeter Fill Lens (D1R only)	D1 Direct (SAL only) D1G Wall Grazer (AWW only) D1R Perimeter Fill (AWL only, NA - REG3)	WTW Wall to Wall (Any row length) LP Light Pocket (Typically 1' increments, fixture stops before wall)	SC Single Circuit	X1 T-Bar 1 5/16" Exposed X1M T-Bar 3/8" Exposed X2 Interlude T-Bar X6 Slot Grid X3B Hard Ceiling (Overlapping flange) X7 Hard Ceiling (Trimless mud-over concealed flange)	UNV (120-277) 347 (Emergency battery requires a Step Down transformer)	ND Non-Dimming DM01 0-10v, 1% Dimming (Standard) LDE1 Lutron Hi-lume 1% EcoSystem LED (Soft fade on, fade-to-black dimming, NA - HO) ECO 1% 0-10v, EldoLED (Logarithmic dimming std) ECDA 1% DALI, EldoLED (Logarithmic dimming std) SOLO 0.1% 0-10v, EldoLED (Dim-to-dark, Logarithmic dimming std) SODA 0.1% DALI, EldoLED (Dim-to-dark, Logarithmic dimming std)	EMHE CA T20 Emergency Battery (D1, D1R-1000, D1G-750 delivered lumens, CA Title 20 compliant, 4' or longer (remote for < 4')) PRUBIN Meticulous Binning and Labeling every LED Board within a 2-Step Mac-Adams Ellipse <b>SENSORS:</b> 205-ON/OFF WattStopper PIR Occupancy 205-STEP: Dim to 50% 205-DM: Dim to 1% LUX Phillips DLH ENL Enlighted 2-Wire DLH & Environmental <b>CORNERS:</b> C2I Lit 90° 2-Way Inside C2O Lit 90° 2-Way Outside C2X Special Angled Connector (Consult factory)



# P43 | Cove & Perimeter

## 4" Perimeter



PRUDENTIAL LTG.

PRULITE.COM 213.746.0360

### DIRECT

#### LOW OUTPUT:

P43-PSTD-FLSH-LED4-LO-SAL-D1

1934 Delivered Lumens  
19 Watts  
101 Lm/W  
4000 CCT

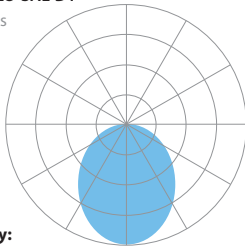

Zonal Lumen Summary:  
0-90 = 100%

878

Vertical Angle	0°	25°	45°	65°	90°
0°	885	885	885	885	885
5°	876	878	878	885	884
15°	828	825	815	803	797
25°	739	727	704	681	670
35°	619	601	569	540	525
45°	421	403	373	349	337
55°	484	463	429	402	388
65°	229	216	196	181	174
75°	115	107	97	90	86
85°	28	26	24	23	23
90°	0	0	0	0	0

#### Luminance Chart:

Angle	0°	45°	90°
45°	5823	5168	4058
55°	5173	4484	3997
65°	4618	3950	3500
75°	3768	3189	2841
85°	2711	2362	2243

UPTO **101** LM/W

FLUSH:	LO	MO	SO	HO
Lm/Ft	400	600	800	900
W/Ft	4	6	8.3	10

### WALL GRAZER

#### LOW OUTPUT:

P43-PSTD-FLSH-LED4-LO-AWW-D1G

1620 Delivered Lumens  
16 Watts  
101 Lm/W  
4000 CCT

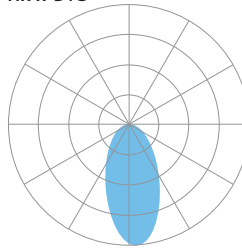

Zonal Lumen Summary:  
0-90 = 100%

1327

Vertical Angle	0°	25°	45°	65°	90°
0°	1317	1317	1317	1317	1317
5°	1271	1285	1311	1327	1296
15°	814	861	981	1159	1258
25°	521	549	638	861	1042
35°	386	393	429	580	828
45°	290	297	309	384	578
55°	205	208	217	253	346
65°	141	145	147	160	187
75°	48	77	84	81	79
85°	24	24	24	23	17
90°	0	0	0	0	0

#### Luminance Chart:

Angle	0°	45°	90°
45°	3390	3618	6847
55°	2952	3134	4958
65°	2768	2881	3646
75°	1543	2683	2572
85°	2292	2292	1746

UPTO **101** LM/W

FLUSH:	LO	MO	SO	HO
Lm/ft	400	600	800	900
W/Ft	4	6	8.3	10

### PERIMETER FILL

#### LOW OUTPUT:

P43-PSTD-FLSH-LED3-LO-AWL-D1R

1594 Delivered Lumens  
16 Watts  
100 Lm/W  
3000 CCT

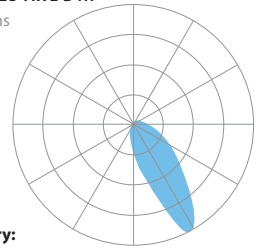

Zonal Lumen Summary:  
0-90 = 100%

1217

Vertical Angle	0°	22.5°	45°	67.5°	90°
0°	461	461	461	461	461
5°	552	545	525	494	460
15°	903	842	698	558	448
25°	1217	1212	1006	634	422
35°	899	944	1064	700	382
45°	614	635	730	705	325
55°	392	402	442	538	250
65°	225	230	244	301	159
75°	98	101	106	123	73
85°	15	16	17	29	12
90°	0	0	0	0	0

#### Luminance Chart:

Angle	0°	45°	90°
45°	7071	8411	3744
55°	5568	6274	3547
65°	4336	4704	3056
75°	3074	3344	2287
85°	1355	1598	1150

UPTO **100** LM/W

FLUSH:	LO	MO	SO	HO
Lm/Ft	400	600	800	900
W/Ft	4	6	8.3	10



# P43 | Cove & Perimeter

## 4" Perimeter



PRUDENTIAL LTG.

PRULITE.COM 213.746.0360

### LUMEN MAINTENANCE

Designed to last with cool running mid-power LEDs projected to maintain 90% (L90) of their initial output for 100,000 hours (at HO), and L70 exceeding 150,000 hours.

### LED SYSTEM

LED modules and drivers are field replaceable.

### PROG

(OPTIONAL)

Programmable light output. Specify desired lumens or watts per linear foot. Min: 2½ w/ft, consult factory for requests above 12 w/ft.

### BINNING

Standard binning (all Prudential LED boards) includes testing at the chip level and board integration to provide consistent color temperature within a 3-step MacAdams ellipse, with +/- 5% lumen output range and +/- .004 Duv.

### PRUBIN™

(OPTIONAL)

Prudential Ltg's exclusive 'job binning' method that ensures color temperature consistency across all luminaires on a project. Meticulously testing and labeling **EVERY LED BOARD** to +/- 25 lumens, +/- 50k CCT and +/- .004 Duv — while also separating positive from negative — allows us to match color, hue and intensity throughout a project and provides a consistent color temperature within a 2-step MacAdams ellipse.

### LABELS

CSA and ETL damp labeled and I.B.E.W. manufactured.

### ELECTRICAL

Must specify LED dimming controls. LED fixtures have constant current driver(s) with less than 20% THD when loaded to a minimum of 60%. Drivers sink a maximum of 6mA per driver. DM01 LED drivers are 0-10V dimmable and are compatible with most 0-10V wall slide dimmers and direct 0-10V analog signal dimmers. Max driver size 1¼" w x 1" h.

### CONSTRUCTION

Housing	20-gauge steel, >20% PC recycled, 100% recyclable.
Lens	Acrylic, 100% recyclable.
X1, X2, X6 Trim	Steel.
X3, X7 Trim	Extruded aluminum.
Weight	<b>FLUSH</b> 4 lbs / ft. <b>3" REGRESS</b> 5 lbs / ft.

### MOUNTING

Recessed into drywall or T-bar ceilings.

### WARRANTY

Single-source, 5 year limited warranty covers standard components and construction.

### WALL GRAZER ORIENTATION

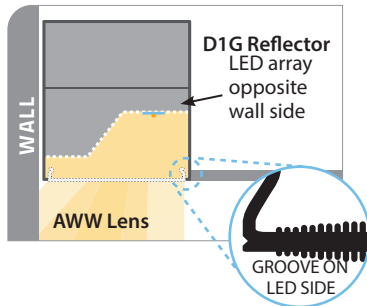

## Smooth Wall Grazing.

A tight, focused beam grazes wall textures evenly, accenting and highlighting details to elevate the visual drama.

Standard Output - 750 lm/ft	Watts/Ft	Ceiling Height	Average Illuminance	Max	Min	Max/Min Ratio
	10	9'	40fc	76fc	16fc	4.75

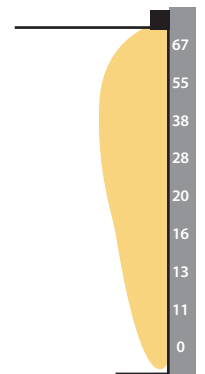

### PERIMETER FILL ORIENTATION

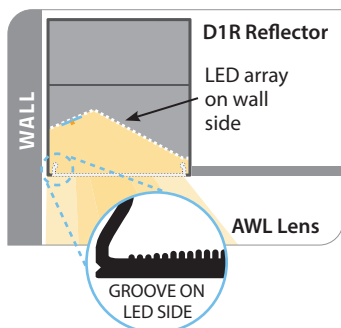

## Perimeter Fill.

Fill a Corridor with Light — from the Perimeter.

It's a perimeter optic that washes corridors in light, offering outstanding light distribution, far more energy efficient than typical soft glow solutions and significantly reduces installation cost. Ideal for corridors where budget and energy efficiency conflict with strict IES requirements for high footcandles.

Suspended, surface mounted or recessed, perimeter lighting system.

Standard Output - 875 lm/ft	Watts/Sq. Ft.	Ceiling Height	Average Illuminance	Max/Min	Max/Min Ratio
	1.25	9'	57fc	79/32	2.5:1

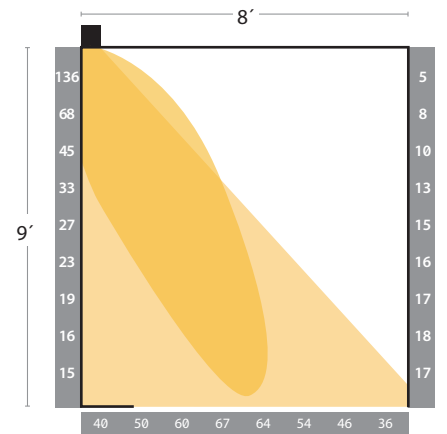

Footcandles along the floor Reflectances 80: 50: 20



# P43 | Cove & Perimeter

## 4" Perimeter



PRUDENTIAL LTG.

PRULITE.COM 213.746.0360

YSW – Seashell White (Matte)	YCH – Champagne (Metallic)
YSL – Silver (Metallic)	YPE – Pewter (Matte)
YRG – Rain Grey (Gloss)	YSTM – Storm Grey (Matte)
YBK – Black (Matte)	YBB – Black (Semi Gloss)
YSKM – Sky (Matte)	YMB – Military Blue (Matte)
YIB – Interstate Blue (Matte)	YSAM – Sapphire (Matte)
YFGM – Forest Green (Matte)	YBR – Bronze (Matte)
YBY – Boysenberry (Matte)	YSRM – Sunset Red (Matte)
YOR – Orange (Matte)	YDAM – Daffodil (Matte)

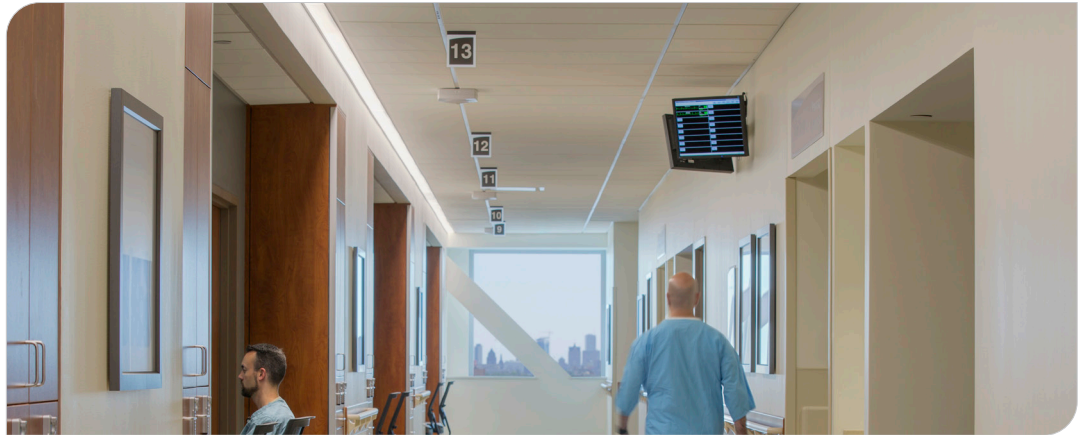

### MOUNTING LOCATIONS

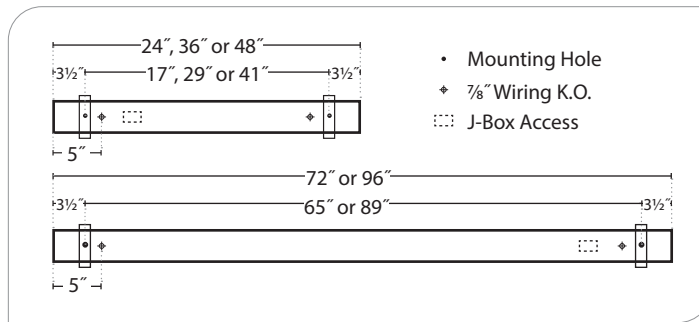

Choose from one of our Premium Colors with no set-up fee.

For paint chip samples, please email: [info@prulite.com](mailto:info@prulite.com)

### CEILING SYSTEMS

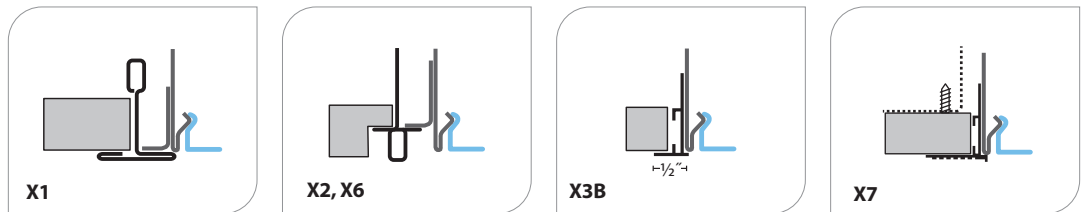

### ADJOINING DETAILS

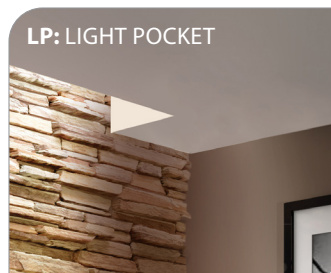
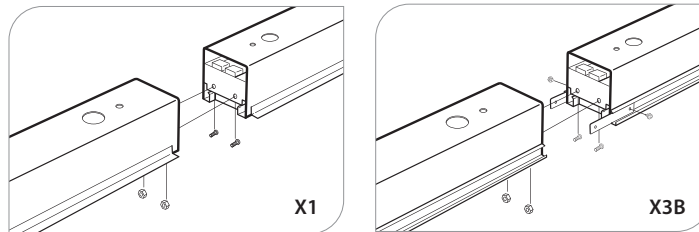



# P43 | Cove & Perimeter

## 4" Perimeter



PRUDENTIAL LTG.

PRULITE.COM 213.746.0360

### CONTROL SENSORS

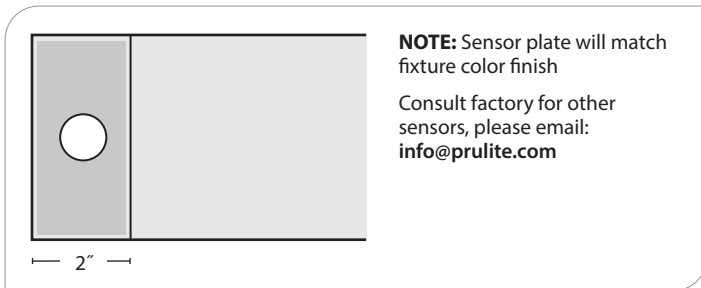
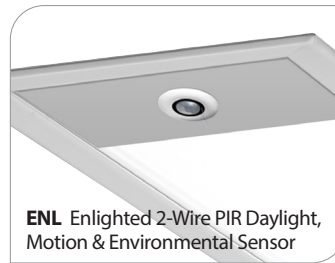

### CORNERS

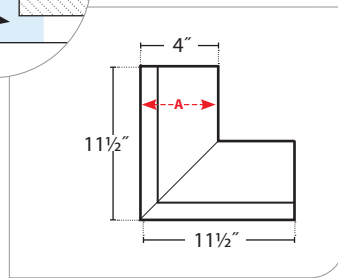
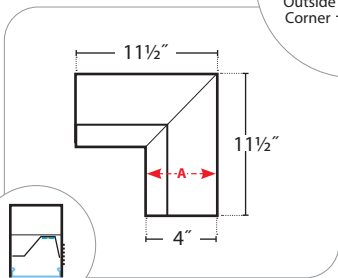
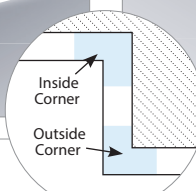
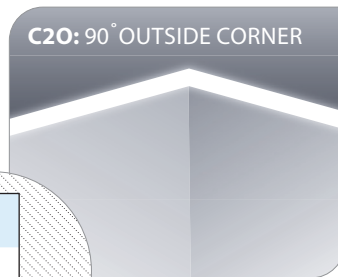
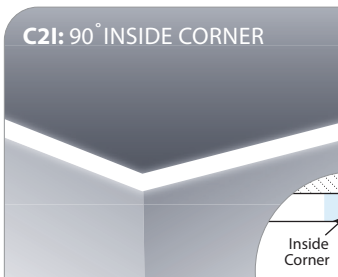

### DISTRIBUTION CROSS SECTIONS

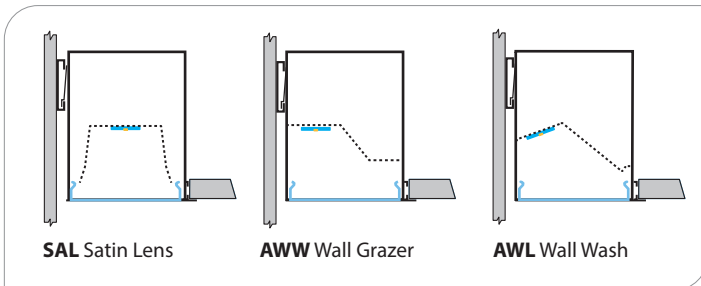

### FIELD TRIMMABLE FILLER KIT

