

Smaller cousin of the popular Snap now with much higher lumen levels (and efficiencies). Improved aesthetic with more LEDs close together for smooth, soft side viewing of lens.

TUNABLE WHITE

Tu Hue Amber Hue
 Blu Hue Chroma Hue

Low Output:
HSS-PRO-LED35-LO-SAL
 2067 Delivered Lumens
 15 Watts
 138 lm/w

UP TO **138** LPW **SMART SPECS**

SAL:	LO	MO	SO	HO
lm/ft	515	880	1200	1550
w/ft	3.75	6.5	9.4	12.5
BLUHUE, TUHUE, TUHUE2, AMBERHUE				
lm/ft	450	670	890	1100
w/ft	4	6	8	10



Lumen output may vary +/- 5%
 Light Loss Factor (LLF) for CCTs other than 3500K:
 4000K +2%, 3000K -5%, 2700K -20%
 90 CRI -15% (3K, 3500K, 4K & 5K)

SERIES	LED COLOR	OUTPUT	NOMINAL LENGTH	SHIELDING	COLOR/ FINISH	VOLT-AGE	MOUNT-ING	CEILING SYSTEMS	DRIVERS	OPTIONS, SENSORS & CORNERS
				SAL						
HSS-PRO Square	LED27 2700K (90CRI) LED3 3000K LED35 3500K	LO Low	2' 3'	SAL Satin Acrylic Lens	TMW Textured Matte White	UNV (120-277)	SUR Surface or Wall Mount (Standard)	X1 T-Bar 1 5/16" or 3/16" Exposed (Standard) Consult factory for 3/16" Tegular	ND Non-Dimming DM01 0-10v, 1% Dimming (Standard) LDE1 Hi-lume 1% EcoSystem LED (Soft fade on, fade-to-black dimming) ECO 1% 0-10v, EldoLED (Logarithmic dimming std) ECDA 1% DALI, EldoLED (Logarithmic dimming std) nLight-Air Acuity nLight Drivers (ECDA driver ONLY) nLight-Wired Acuity nLight nIO Drivers (ECO driver ONLY, Requires Remote Driver) SOLO 0.1% 0-10v, EldoLED (Dim-to-dark, Logarithmic dimming std) SODA 0.1% DALI, EldoLED (Dim-to-dark, Logarithmic dimming std) STEP Signify Advance Step Dimming 2WIRE ELV/Forward/Reverse Phase Driver PRUHUES: E10V 2 Channel Color Control EDALI 2 Channel Color Control EDMX ChromaHue or Static White	EMHE CA T20 Emergency Battery (1350 Delivered lumens; CA Title 20 compliant; 4' or longer) ETS-DR Iota ETS-DR Emergency Transfer Switch EBCP1G/2G Single/ Dual Gang (Electrical Box Cover Plate/Mud Ring) JA8 90 CRI, ECO Driver Only (consult factory for pricing) PruTune Wall Device (EDALI driver only, one PruTune device for each zone)
HSR-PRO Round	LED4 4000K LED3-90 3000K (90CRI) LED3-90 3500K (90CRI) LED4-90 4000K (90CRI) LED5-90 5000K (90CRI)	MO Medium SO Standard HO High	4' 5' 6' 7' 8' R (Row length to 1/8")		YGW Gloss White (Standard) Y Premium Color CC Custom Color LUXE METALLICS: YBZ Bronze YCP Copper Penny YGN Gold Nugget	347 (Emergency battery requires a Step Down transformer)	CA48", 96" or 144" Aircraft Cable (Adjustable)	X2 Dimensional T-Bar Arm-strong Inter-lude® X3 Hard Ceiling X6 Slot Grid or Interlude		SENSORS: (NA w/EDMX) 205 WattStopper PIR Occupancy 205-ON/OFF 205-STEP: Dim to 50% 205-DM: Dim to 1% (NA HO or LGP) ATHENA Lutron RF (Dim-to-Off Standard) LVOC## Lutron Vive (Occ & RF) LVRF## Lutron Vive (RF Only) ## Requires Lutron driver NXSMP Hubbell (Occ) rES7 Daylight+ (PIR Acoustic) (Occ) (nLight-Air) Part Number: rES7-PDT-180D-G2 nES7 Daylight+(PIR Acoustic) (Occ) (nLight-Wired) Part Number: nES-PDT7-ADCX 505 WattStopper Ultrasonic Occupancy (SUR on wall mount only) 505-STEP: Dim to 50% 505-DM: Dim to 10% (NA HO or LGP) LUX Philips DLR
	PRUHUES: bios STATIC: BLU3S BLU35S BLU4S DYNAMIC: BLU3D* BLU35D* BLU4D* *Dynamic BIOS, SkyBlue spike can be dimmed, CCT warms slightly TU TuHue 2700-6500K Tunable White TU2 TuHue 2200-5000K Tunable White AMB AmberHue Warm Dim 2200K-5000K CHR ChromaHue RGBW (DMX at HO only)	PROG Programmable Light Output (Specify desired lm/ft or w/ft)	Row lengths are typically made up of 8' and 4' fixtures, (eg. 12' row is (1) 8' and (1) 4'), unless SRL Symmetric Row Lengths are specified NOTE: Individual fixtures are NOT intended for row mounting For Patterns, Specifiers may write in 'Pattern' and include a drawing with corners and dimensions							CORNERS: C2 Unlit 90° 2-Way C2-120 Unlit 120° 2-Way C3 Unlit 90° 3-Way C3-120 Unlit 120° 3-Way C4 Unlit 90° 4-Way All corners available HSS square only



PHOTOMETRICS

Low Output:
HSS-PRO-LED4-LO-SAL
 2067 Delivered Lumens
 15 Watts
 138 lm/w
 3500 CCT
 Test
 #104160086LAX-011

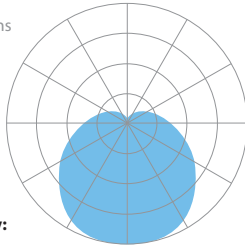

Zonal Lumen Summary:
 0-90 (Down) = 79%
 90-180 (Up) = 21%

417

Vertical Angle	0°	25°	45°	65°	90°
0°	399	399	399	399	399
5°	400	400	402	406	406
15°	380	390	402	413	417
25°	345	365	388	408	415
35°	298	328	363	392	403
45°	244	282	330	368	383
55°	187	232	288	335	353
65°	128	178	242	293	314
75°	71	125	192	246	267
85°	23	78	145	197	216
90°	0	60	125	175	194
95°	0	58	120	168	185
105°	0	51	111	153	168
115°	0	41	96	135	148
125°	0	34	76	108	121
135°	0	26	59	83	92
145°	0	18	44	62	68
155°	0	13	27	40	44
165°	0	0	20	29	31
170°	0	0	10	12	0

LUMEN MAINTENANCE

L70 — 200,000+ Hours
L90 — 100,000+ Hours (LO, MO & SO)
L90 — 60,000+ Hours (HO)

LED SYSTEM

LED modules and drivers are field replaceable.

PROG (OPTIONAL)

Programmable light output. Specify desired lumens or watts per linear foot. Min: 3.75 w/ft, Max 12.5 w/ft.

LABELS

CSA and ETL damp labeled and I.B.E.W. manufactured.

ELECTRICAL

Must specify LED dimming controls. LED fixtures have constant current driver(s) with less than 20% THD when loaded to a minimum of 60%. Drivers sink a maximum of 6mA per driver. DM01 LED drivers are 0-10V dimmable and are compatible with most 0-10V wall slide dimmers and direct 0-10V analog signal dimmers. Max driver size 1.25" w x 1" h.

32v Forward Voltage (+/- 1 volt based on drive current)

Drive Currents: LO: 100mA, MO: 100mA, SO: 250mA, HO: 325mA

CONSTRUCTION

Housing Die-formed 22-gauge steel, >20% PC recycled, 100% recyclable
End Caps Spring-fastened aluminum, >25% PC recycled, 100% recyclable
Lens Single-piece (up to 8' lengths) extruded acrylic, 100% recyclable
Weight 1.5 lbs /Ft.

MOUNTING

Recessed into drywall or T-bar ceilings

WARRANTY

Single-source, 5 year limited warranty covers standard components and construction.



FINISH COLORS

STANDARD:

TMW — Textured Matte White	YGW — Gloss White
----------------------------	-------------------

PREMIUM:

YSW — Seashell White (Matte)	YRG — Rain Grey (Gloss)
YPE — Pewter (Matte)	YSTM — Storm Grey (Matte)
YBK — Black (Matte)	YBB — Black (Semi Gloss)
YSKM — Sky (Matte)	YMB — Military Blue (Matte)
YSAM — Sapphire (Matte)	YIB — Interstate Blue (Matte)
YBR — Bronze (Matte)	YSRM — Sunset Red (Matte)
YOR — Orange (Matte)	YDAM — Daffodil (Matte)
YFGM — Forest Green (Matte)	YSL — Silver (Metallic)

LUXE METALLICS:

YCP — Copper Penny (Metallic)	YGN — Gold Nugget (Metallic)
YBZ — Bronze (Metallic)	

Choose from one of our Premium Colors with no set-up fee.

For paint chip samples, please email: info@prulite.com



MOUNTING LOCATIONS

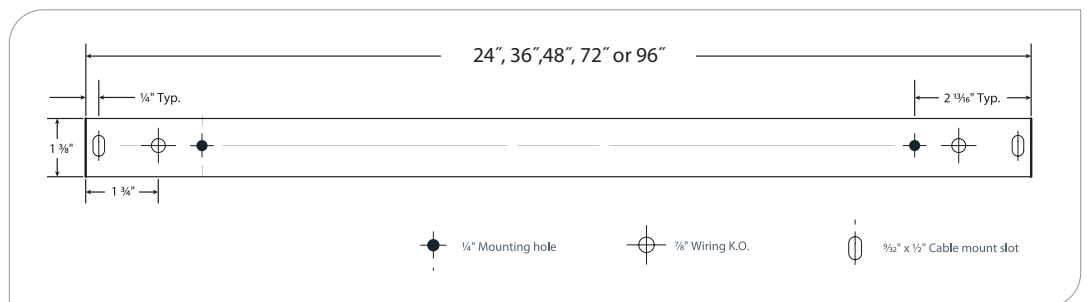

EBCP ELECTRICAL BOX COVER (OPTIONAL)

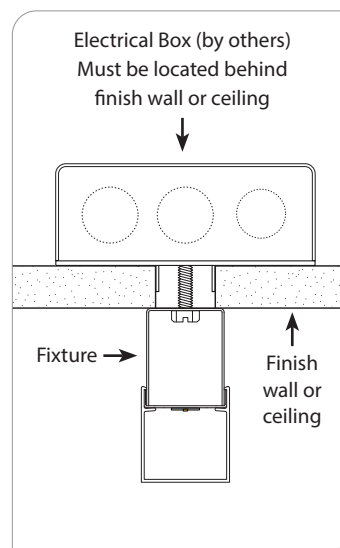
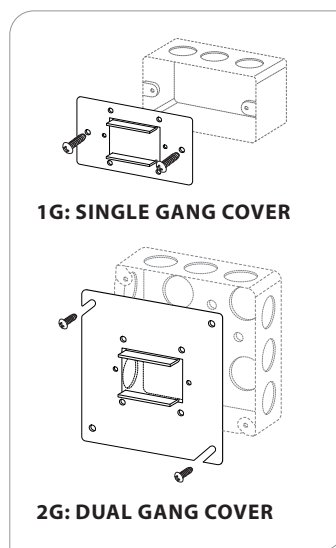

ADJOINING DETAIL

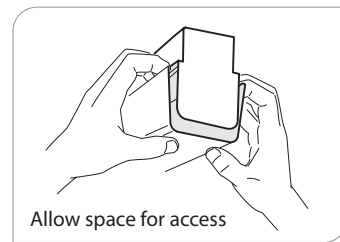
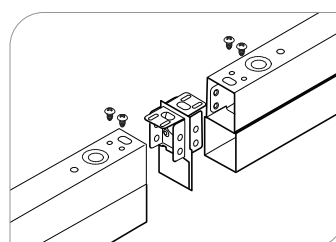

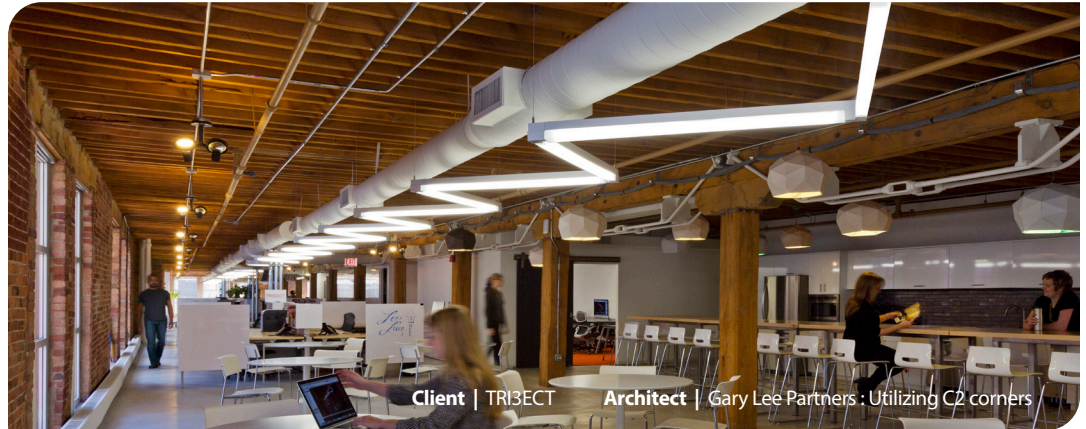

Client | TRI3ECT Architect | Gary Lee Partners : Utilizing C2 corners

CORNERS

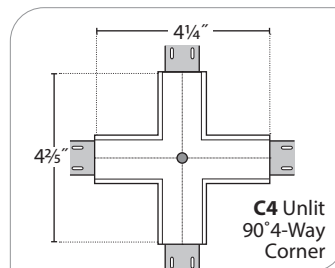
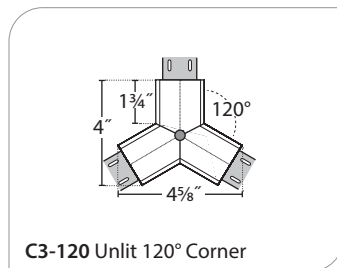
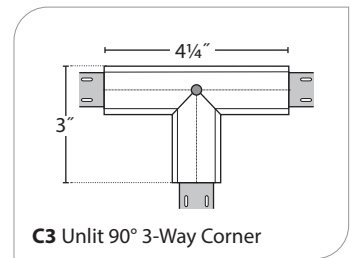
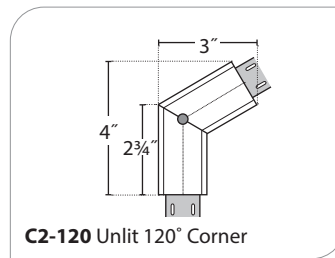
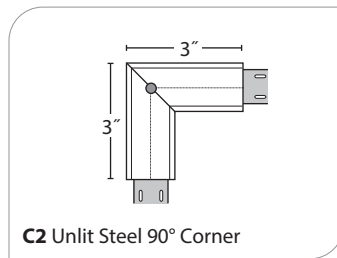

NOTE: All corners available HSS square only



Prudential Lighting's **TuHue** Tunable White provides warm to cool white light simulating sunlight. Controlling the light source color temperature offers differing design aesthetics with potential benefits via circadian rhythm support. Blue light for alertness while warm light conveys tranquility.

- 2700K-6500K or 2200K-5000K.
- Adjust the color temperate and brightness separately.
- Simulates warm to cool to warm transition of sunlight.

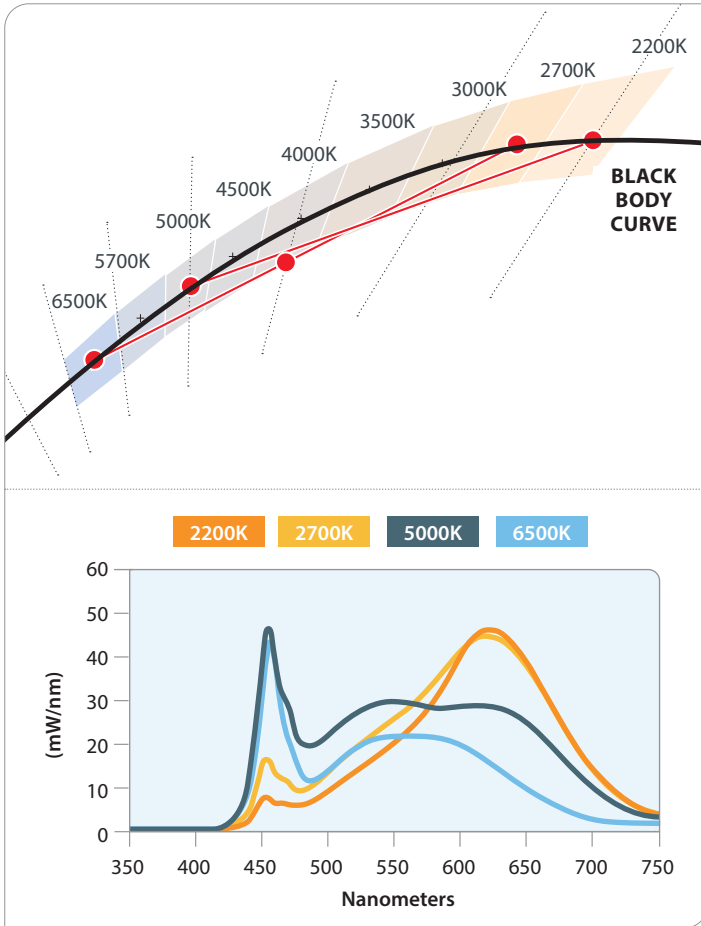

BluHue BIOS SkyBlue™ circadian LED lighting brings the benefits of blue skies inside. Newly discovered blue-sky receptors in our eyes drive improved daytime alertness, mood, brain function, and strengthens circadian rhythms leading to overall better health and well-being.

- Circadian rhythms play an integral role in physical and mental health.
- BluHue BIOS SkyBlue pinpoints peak 490nm sensitivity to provide the most benefit from an electric light source.
- At night, simply dim the lights to remove SkyBlue™ wavelengths (specify "Blu_D" to dim Cyan SkyBlue spike separately [night model]).

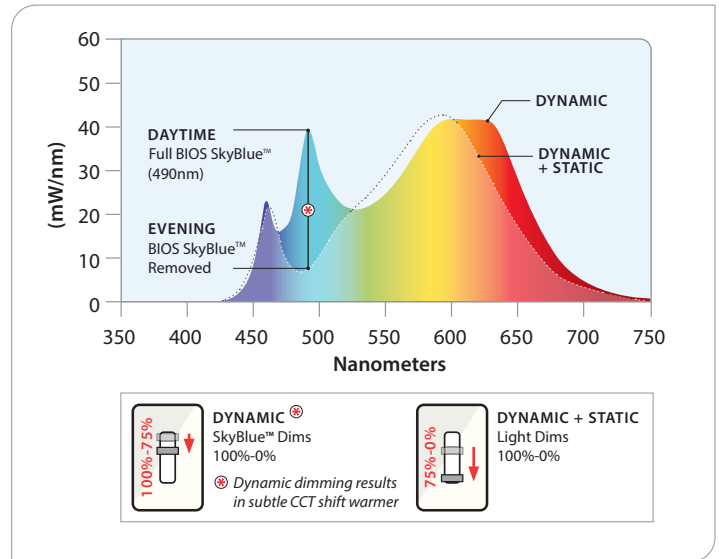

AmberHue is Prudential Lighting's Warm Dim offering. It transitions bright white light to warm amber light as brightness is dimmed, reflecting sunlight's transitioning from intense blue midday light to a dimmed golden hue near sunset, also reminiscent of soft glowing candlelight.

- Warm Dim 2200K-5000K.
- Color temperature warms as the luminaire is dimmed.
- Calm, relaxing mood communicated – hospitality, residential feel.

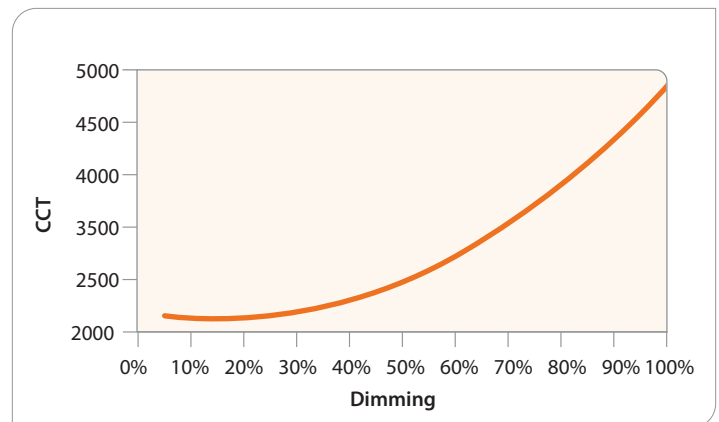



ChromaHue offers a vibrant full gamut of colors for seemingly endless architectural interior applications. Rich color-changing light offers tremendous design flexibility while white light can be achieved with the White chip, or mixing of Red, Green and Blue light. No longer just for the entertainment industry, ChromaHue can be intermixed on BionicPro luminaires for mood-creating indirect illumination combined with static white direct light.

- RGBW LED array (Red, Green, Blue, White) with full spectrum color and white light on the black body curve.
- Four-channel control, DMX drivers.
- Any color point within the triangle can be reached by setting the proper output levels for each individual red, green, blue and white channels.
- Standard DMX is one zone with one XLR drop at start, one XLR return at the end.

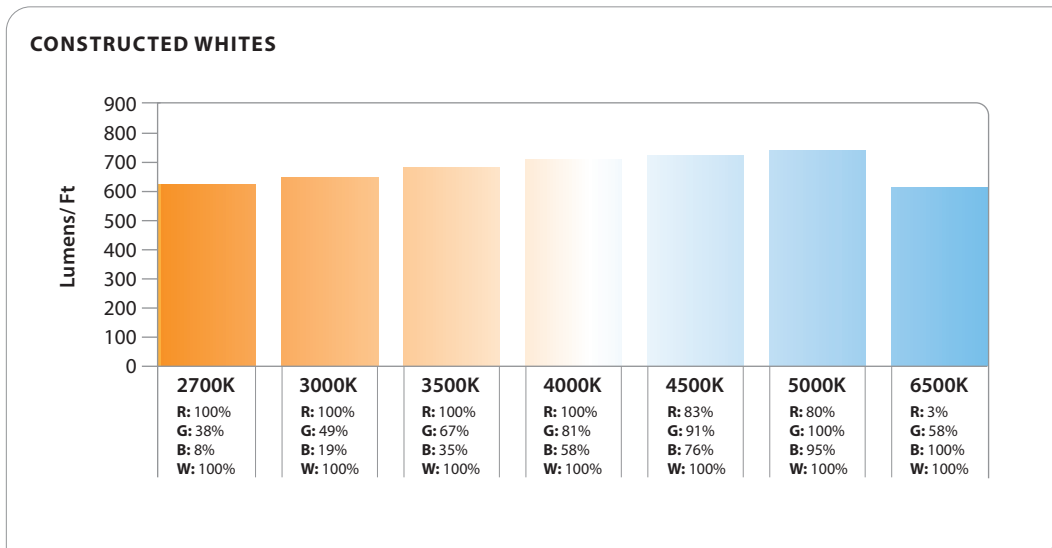
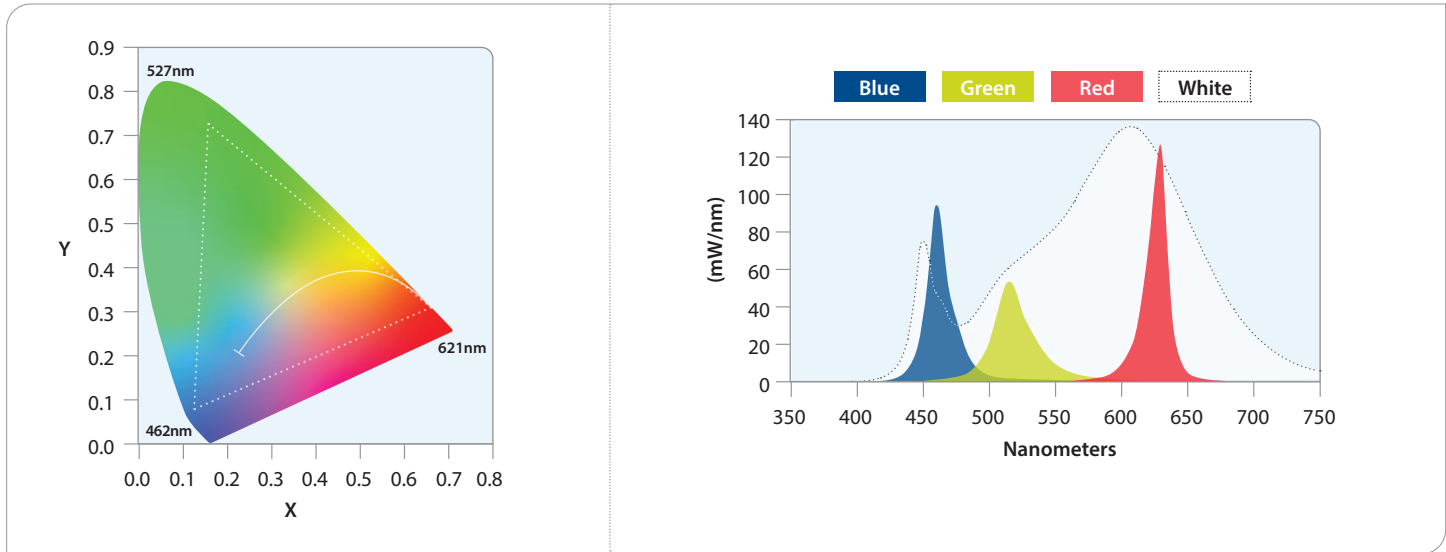



PRUTUNE WALL DEVICE

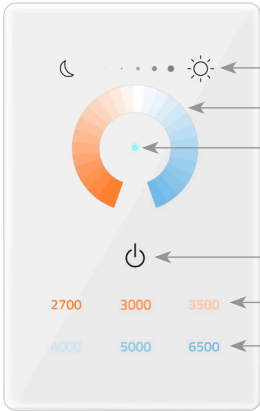

BRIGHTNESS: 0.1%-100%

COLOR WHEEL

POWER INDICATOR
RED : OFF
BLUE : ON

ON / OFF

PRESET COLOR TEMPERATURES

PRUTune DALI device includes:

- Easy-to-understand user control with intuitive design
- Out-of-the-box set-up, no commissioning needed
- Color wheel for color change from 2700K to 6500K
- Dimming to 0.1% (255 Steps)
- Six preset colors (2700K, 3000K, 3500K, 4000K, 5000K, 6500K)
- Must use DALI driver, consult factory to control non-Prudential Ltg Tunable White fixtures
- Control one (1) zone - up to 30 drivers
(Consult factory for fixture quantity dependant upon fixture type, size & output)

PRUTune + EMHE: — Prutune does not have memory

- Once normal power is restored, the controller sends a signal of 100% intensity and 6500K CCT

EXPLODED VIEW

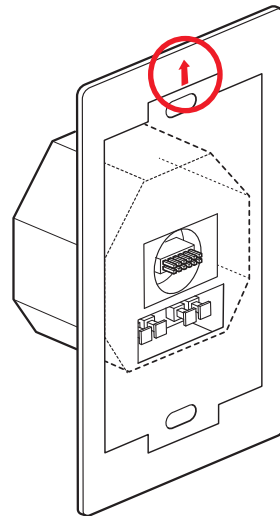
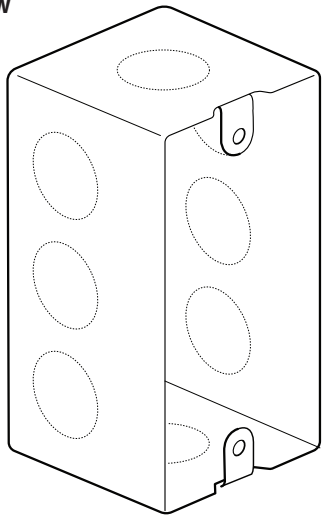

Ensure arrows are aligned when assembling 'Pru wall device'

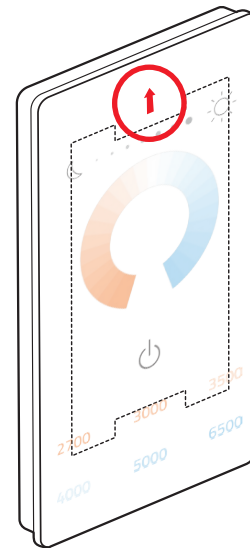



LM79 & TM30 DATA:

	MEASURED CCT	MEASURED LUMENS	CRI	R9	DuV	SPD	TM30 — COLOR VECTOR	TM30 — COLOR DISTORTION
LED27	2680	80%	93	58	0.001		 89 Rf	 97 Rg
LED3	3042	95%	82	6	0.001		 81 Rf	 92 Rg
LED3-90	3016	85%	93	61	0.000		 88 Rf	 96 Rg
LED35	3482	100%	82	3	0.002		 81 Rf	 92 Rg
LED35-90	3417	85%	93	67	0.000		 88 Rf	 96 Rg
LED4	3952	102%	82	4	0.003		 81 Rf	 92 Rg
LED4-90	3882	85%	92	67	0.003		 87 Rf	 96 Rg
LED5-90	4889	85%	94	84	0.002		 86 Rf	 95 Rg











LM79 & TM30 DATA:

		MEASURED CCT	MEASURED LUMENS	CRI	R9	LED27	SPD	TM30 — COLOR VECTOR
BH3S&D	bioS 3000K	2779	2758	87	81	0.003		
	BH3D SKY BLUE DIMMED	2715	2425	82	3	0.002		
BH35S&D	bioS 3500K	3245	3488	85	87	0.003		
	BH35D SKY BLUE DIMMED	3061	2502	83	7	0.001		
BH4&D	bioS 4000K	3624	2993	85	86	0.004		
	BH4D SKY BLUE DIMMED	3388	2585	83	5	0.002		
TH	LED27	2684	4056	92	57	0.0001		
	LED65	6061	4052	82	-1	0.006		
TH2	LED22	2209	4012	92	52	0.0005		
	LED50	4796	4044	93	77	0.004		
CH	2700K	2632	4076	82	50	0.003		
	3500K	3388	4424	83	5	0.002		
	4000K	3977	4444	83	29	0.003		
	5000K	5233	4548	84	21	0.003		



SENSORS

				
<p>205: Wattstopper</p>	<p>LVOC: Lutron Occupancy /Daylight Sensor</p>	<p>LVRF: Lutron Vive Control Node</p>	<p>NXSMP: Hubbell Occupancy /Daylight Sensor</p>	<p>ATHENA</p>
<p>Low voltage PIR fixture integrated occupancy sensor.</p>	<p>Measures light in the space (daylighting) while detecting people moving within an area using passive infrared to determine occupancy.</p> <p>Controls the lights to balance the light level in the space, combining convenience, exceptional energy savings, and ease of installation.</p>	<p>Provides wireless control of the fixture when neither occupancy nor daylight sensing is needed.</p>	<p>Hubbell Integrated/embedded networked lighting control, luminaire-level lighting control, LLLC.</p> <p>PIR motion sensor for automatic On/Off control.</p> <p>Integrated daylight sensor for daylight harvesting and/or lumen maintenance.</p> <p>Bluetooth radio provides wireless control of luminaire.</p> <p>Simple plug-in connection to NX Fixture Modules.</p> <p>Wireless Internet.</p>	<p>The Athena wireless node is a radio frequency (RF) device that enables simple, digital control of individual light fixtures in an Athena control system.</p> <p>The small size and compatibility with a wide variety of drivers allow for seamless integration with common commercial lighting fixtures from any manufacturer.</p> <p>Requires drivers with auxiliary power, consult factory for lead times</p>

			
<p>NLT-AIR-rIO: Daylight+Occ</p>	<p>NLT-AIR-ADCX: Daylight+(PIR Acoustic) Occ</p>	<p>NLT-WIRED-nIO: Daylight+Occ</p>	<p>NLT-WIRED-ADCX: Daylight+(PIR Acoustic) Occ</p>
<p>The rIO is a fixture embedded low voltage wireless nLight AIR device capable of individual fixture control and analog or digital dimming. This smart device results in the luminaire being “nLight AIR-enabled” — making it an addressable nLight AIR device. It uses a 900MHz radio to communicate with other nLight AIR devices, such as occupancy sensors, photocells, wall switches, powerpacks and other nLight AIR-enabled luminaires. This allows for advanced operation and design flexibility ranging from stand-alone rooms to building and campus-wide networks.</p>	<p>The nLight® AIR rES7 sensor is an in-fixture, low voltage, digital sensor providing embedded wireless lighting control, analog or digital dimming, occupancy detection and daylight harvesting capabilities.</p> <p>The rES7 is designed for mounting heights up to 20 ft in indoor luminaires. The rES7 sensor provides Passive Infrared (PIR) occupancy detection over a 15-20 ft (4.57 - 6.10 m) radial coverage pattern and photocell light level detection in one compact low profile design with optional Dual Technology, which adds Microphonics™ to PIR detection. The rES7 sensor is ideal for occupancy and daylighting control in suspended or recessed luminaires.</p>	<p>nLight digital nIO modules are low voltage control devices that enable digital control of LEDcode enabled eldoLED LED drivers. Through eldoLED's bi-directional 2-wire interface, these modules deliver natural, flicker-free high performance dimming while eliminating common issues related to 0-10 VDC alternatives. The modules also enable the eldoLED LED Drivers to be addressable, as well as capable of digitally communicating with other nLight controls such as occupancy sensors, photocells, and WallPods. This allows for advanced operation and design flexibility ranging from stand-alone rooms to building and campus-wide networks.</p>	<p>The nES7 is a small passive infrared occupancy sensor designed to be easily embedded into luminaires. This sensor provides excellent line of sight 360° PIR detection of small motion and walking motion. The nES7 is ideal for small rooms without obstructions or areas with primarily walking motion (e.g. corridors, library stacks). Additionally, an optional integrated photocell enables daylight harvesting control as well. Typically one or more nES7 sensors are paired with an nLight controller within an nLight enabled luminaire.</p> <p>For rooms like classrooms and private offices or any space with obstructions, the nES PDT 7 dual technology sensor is recommended.</p>